



Perfect Appearance Excellent Performance

精 于 静 精 于 动

F4U-4 Corsair

OPERATING MANUAL



<http://www.facebook.com/FMSmodel>



www.fmsmodel.com

Please visit both our Facebook fanpage and our homepage for updated product information

WARNING

 **WARNING:** Read the ENTIRE instruction manual to become familiar with the features of the product before operating. Failure to operate the product correctly can result in damage to the product, personal property and cause serious injury.

This is a sophisticated hobby product and NOT a toy. It must be operated with caution and common sense and requires some basic mechanical ability. Failure to operate this Product in a safe and responsible manner could result in injury or damage to the product or other property. This product is not intended for use by children without direct adult supervision.

This manual contains instructions for safety, operation and maintenance. It is essential to read and follow all the instructions and warnings in manual, prior to assembly, setup or use, in order to operate correctly and avoid damage or serious injury.

Safety Precautions and Warnings

As the user of this product, you are solely responsible for operating in a manner that does not endanger yourself and others or result in damage to the product or the property of others. This model is controlled by a radio signal subject to interference from many sources outside your control. This interference can cause momentary loss of control so it is advisable to always keep a safe distance in all directions around your model, as this margin will help avoid collisions or injury.

Age Recommendation: Not for children under 14 years. This is not a toy.

- Never operate your model with low transmitter batteries.
- Always operate your model in an open area away from cars, traffic or people.
- Avoid operating your model in the street where injury or damage can occur.
- Never operate the model in the street or in populated areas for any reason.
- Carefully follow the directions and warnings for this and any optional support equipment (chargers, rechargeable battery packs, etc.) you use.
- Keep all chemicals, small parts and anything electrical out of the reach of children.
- Moisture causes damage to electronics. Avoid water exposure to all equipment not specifically designed and protected for this purpose.
- Never lick or place any portion of your model in your mouth as it could cause serious injury or even death.

FMS Kindly Reminder



Thank you for purchasing a FMS model product. Our goal is to provide high quality products and offer great customer service. If you have any problems with your product or want to offer suggestions for improvements (such as plane design, packaging, building instructions, etc.) please feel free to contact us at

info@fmsmodel.com

Charge the battery

The F4U Corsair kit package may or may not contain a Li-Po Battery.

Caution: All instructions and warnings must be followed as instructed. Mishandling of Li-Po batteries can result in fire, personal injury, or property damage.

Battery Naming convention

- A battery is a collection of cells. All batteries have a naming convention which is designed to help the user identify how many cells the battery is made of and in what configuration they are. Every cell has a capacity (stored energy), measured in mAh (milliamp hours) and a voltage, measured in volts. Cells within a battery can be connected in series or parallel. Please note that all the cells must be exactly alike.
- Series connection - add the voltages of each cell together while the capacity of the whole battery remains the same as for 1 cell.
Parallel connection - add the capacities of each cell together while the voltage of the whole battery remains the same as for 1 cell.
- For example, let's say we have a bunch of 1000mAh 3.7v cells.
- If we connect 3 cells in series, the battery would be a 11.1v (3.7v + 3.7v + 3.7v) 1000mAh battery. If we connect 3 cells in parallel, the battery would be a 3.7v 3000mAh (1000mAh + 1000mAh + 1000mAh) battery.
- Now, with regard to the naming convention, the battery is named according to the following: the voltage of the whole battery, the capacity in mAh, the number of cells in series in the battery.
- The above 2 examples would be named as follows:
 - 3s1p 11.1v 1000mAh - a battery made up of 3x 1000mAh cells connected in series.
 - 1s3p 3.7v 3000mAh - a battery made up of 3x 1000mAh cells connected in parallel.
- A 14.8v 2200mAh 4s1p LiPo battery would mean that the battery is made up of 4x 2200mAh 3.7v LiPo cells connected in series.

Battery warning:

- By handling, charging or using the included Li-Po battery you assume all risks associated with lithium batteries.
- If at any time the batteries begin to swell, or balloon, discontinue use immediately! Charging or discharging a swelling or ballooning battery can result in fire.
- Always store the batteries at room temperature in a dry area to extend the life of the battery. Always transport or temporarily store the battery in a temperature range of 40-120°F. Do not store battery or model in a car or in direct sunlight. If stored in a hot car, the battery can be damaged or even catch fire.

- Never use a Ni-Mh or Ni-MH charger. Failure to charge the battery with a compatible charger may cause fire resulting in personal injury and property damage.
- Never discharge Li-Po cells to below 3V.
- Never cover warning labels with hook and loop strips.
- Never leave charging batteries unattended.
- Never charge damaged batteries.
- **Charge the in stored battery for F4U (14.8V, 25C, 2600mAh)**
Please charge your LiPo battery only on a charger specifically designed for LiPo batteries. Those chargers will have a special LiPo charging mode. There may also be just a normal charge mode, as well as a balance charge mode. Please check your LiPo before you charge it. Look for signs of swelling of the individual cells, any discolouration or if any part of the pack is warm. If your pack has any of those characteristics, please DO NOT charge or discharge it.
- Now that the naming convention has been described, please make sure of the following when charging:
 - When you plug your battery in to charge and begin charging, wait and make sure that the voltage on the display screen of the charger does not exceed whatever the pack voltage is, the voltage should not exceed 16.8v (4.2v x 4).
If the charger is capable of doing a balance charge (charging all the cells in the pack individually and at the same time), make sure that all the cells are around the same voltage
 - Always charge your battery on a non-flammable surface or in a container specially designed for charging LiPo batteries
 - If you had a 2600mAh battery, the charge rate would be 2.6A (2600/1000).
Note: Do not charge the battery over the rate we have recommended for properly prolong the life cycle of the packs.
- **LiPo battery disposal**
In order to properly dispose of a LiPo battery, you must first discharge it as low as possible. Please, if the battery has been damaged DO NOT discharge it, just proceed with the next step. Fill a bucket or some plastic container (NO METAL) with water, and add salt. Add approximately 1/4 cup of salt for every litre of water. The container may have a lid but must not be air tight. Immerse the battery in the salt water fully. Make sure that even the power connectors are submerged. Leave the battery for at least 2 weeks.
After 2 weeks, remove the battery, wrap in newspaper and dispose of in rubbish bin like normal rubbish.

The control horn installation

1. The control surface horns for the rudder and elevator are stapled to the bags containing the rudder and elevator, do not accidentally discard them.



2. Install the elevator control surface horns on the bottom of the elevator surface with the screws provided in the small plastic bag. The side of the stabilizer that contains the washer faces down, make sure to install the control horns on the opposite side. Make sure the control surface horns are facing into the right direction before installation. **Note:** The longer screws always located on the leading edge side of all the control surface.

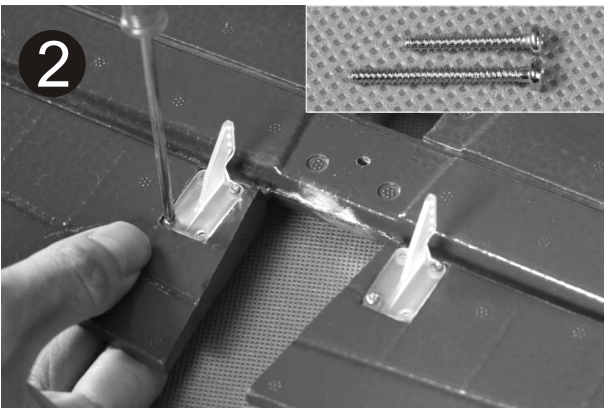

3. Always make sure that the screws are grabbing into the back plates of the control horns. **Note:** It is very important that these parts are holding tight during flight.

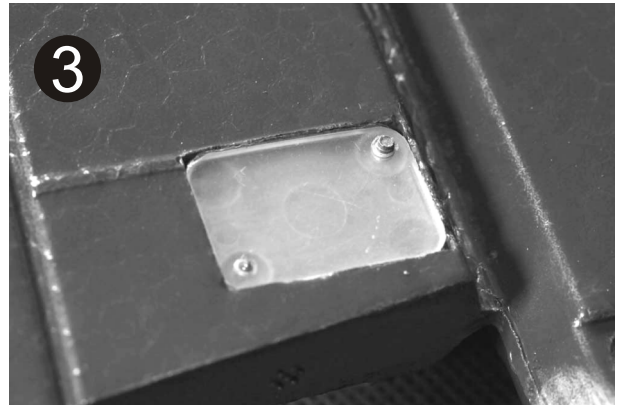

4. Attach the rudder surface control horn to the port side of the rudder.

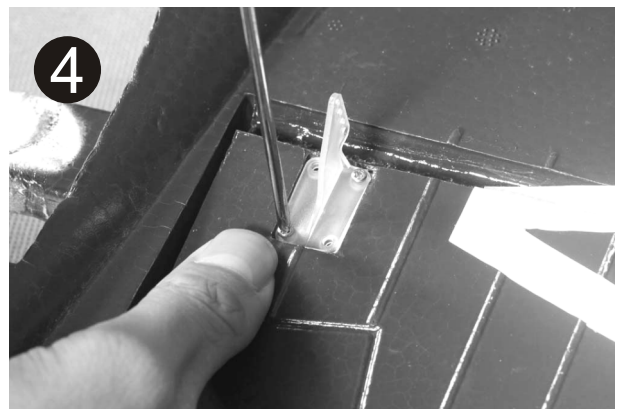

5. The aileron accessories part are include in the bag with the label "Aileron".



The control horn installation

6. Now attach the aileron surface control horns to the bottom of the lower main wing.

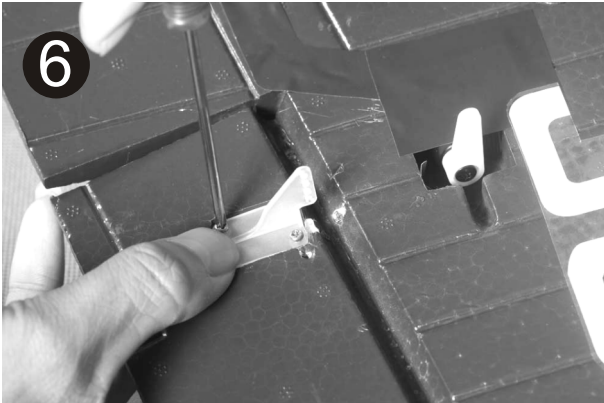

7. Attach the flaps control horn the same with the aileron .

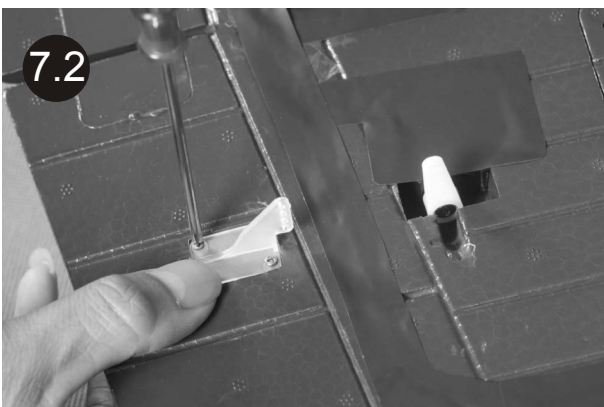

One piece main wing building

1. Insert the in stored fiberglass tube into the socket on the main wing root.
Note: When sliding the tubes into the wings, they should go in easily. Do not push them farther than they will go with little resistance. That would push the wing tubes into the foam of the wing and prevent them from fully inserting into the opposite wing half. Insert the connecting tube till the white mark the factory pre spackled.



2. Connect the rest half wing to the rods, slide it in slightly. Make sure there is no slot between this two main wing panels. If not, you have to check the obstruction out.

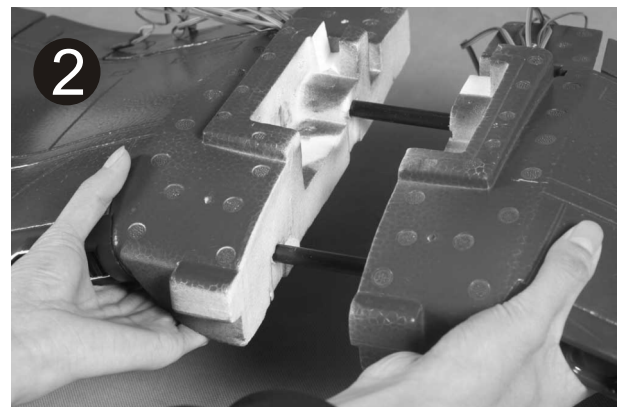

step3

Test the main wing electric device

1. Before getting started, bind your receiver with your transmitter. Please refer to your **Transmitter Manual** for proper operation. **CAUTION:** To prevent personal injury, DO NOT install the propeller assembly onto the motor shaft while binding the receiver to your transmitter.
2. Connect the wing leads to the harness the first. Two ailerons servo parallel with two landing light to the four way harness labeled **AILE**, flaps and the Nav lights to the harness labeled **CH6**, main landing gears(**CH5B**) and the fairing door servos(**CH5C**) to the sequencer.
Note: Make sure the leads polarity have been correctly inserted into the socket to assure the servo and other electronic parts works properly.

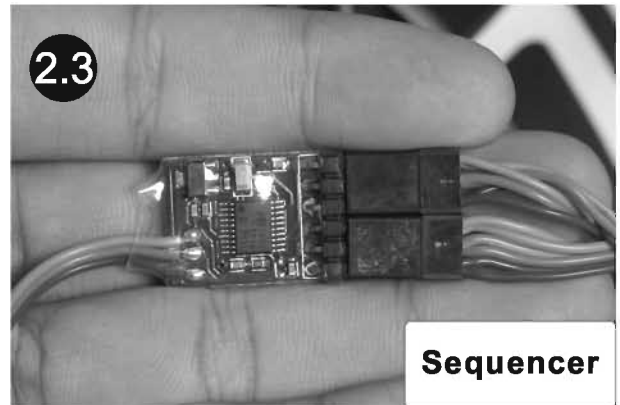
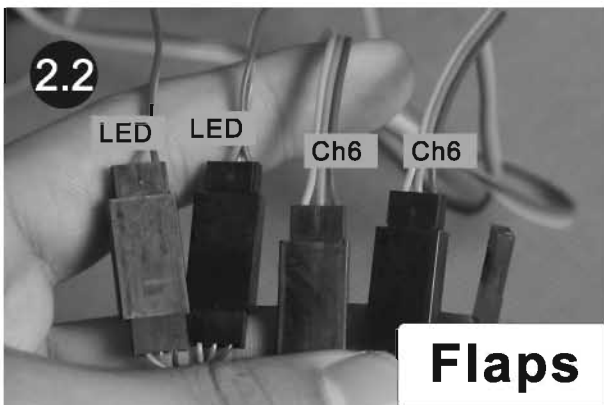
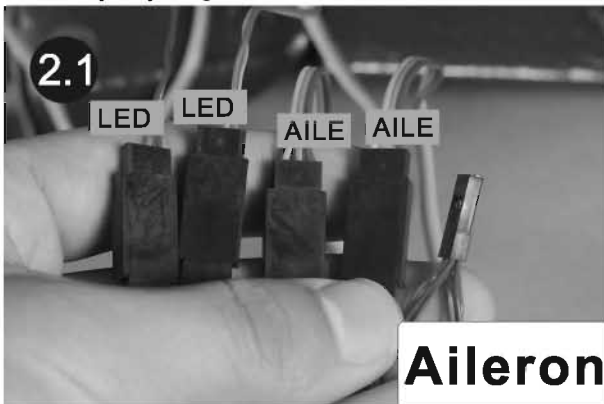

Tips: The orange and/or the white cables aligned on the same side when the cable connection completed.

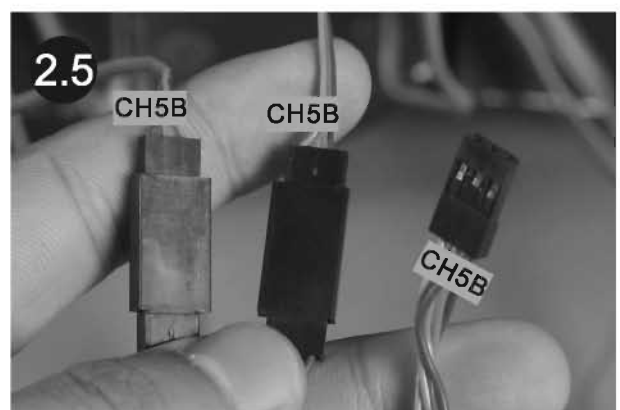
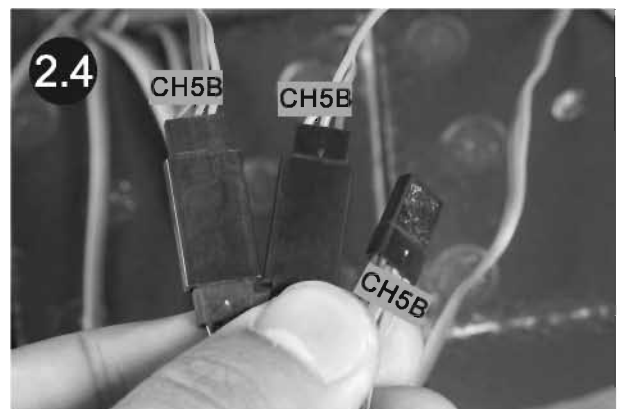

Test the main wing electric device

3. The schematic of the receiver connection

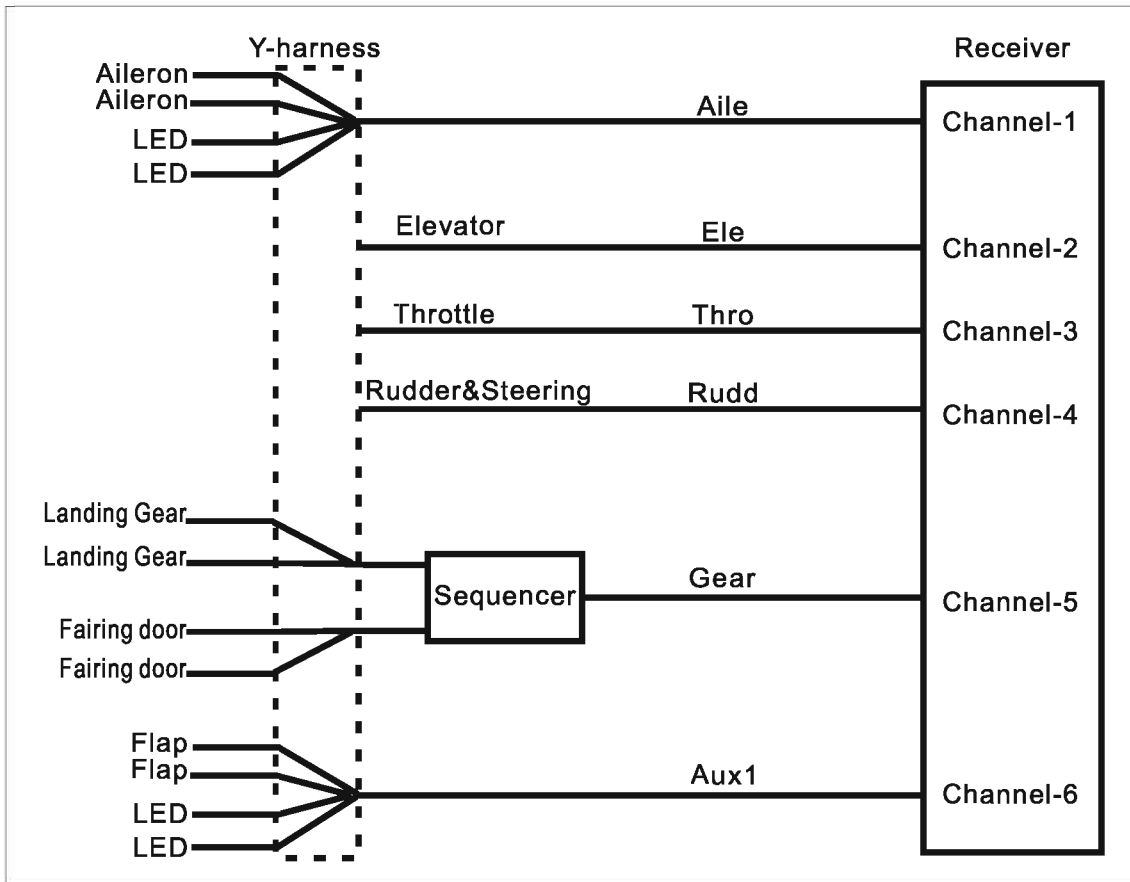

4. Diagram for the sequencer connection.

Note: With the chip side of the sequencer face up. Ch5 B for the retracts Ch5 C for fairing door driving servos. The signal wire of the leads (The orange wires) on the same side.

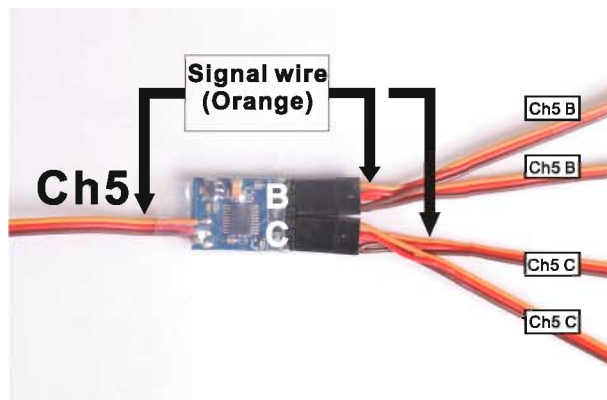

Note: All servo and retract leads have been specifically labeled for your convenience. Use the provided Y-harness for situations where two or three servos are controlled by one channel; for example ailerons, landing gear, and flaps. Refer to the diagram above for recommended connections.

step3

Test the main wing electric device

5. Make sure the main landing gears and the faring doors work well in order, if not, you have to check that if the lead goes into the right port on the sequencer.

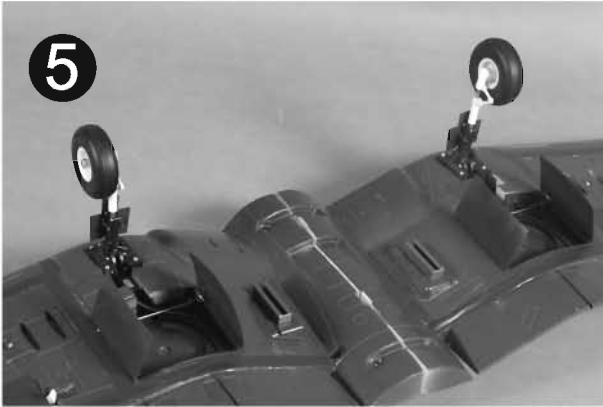

6. Make sure the navigation light on port side(L) wing tip emitting red beams, the starboard(R) is green. Two landing light are white.

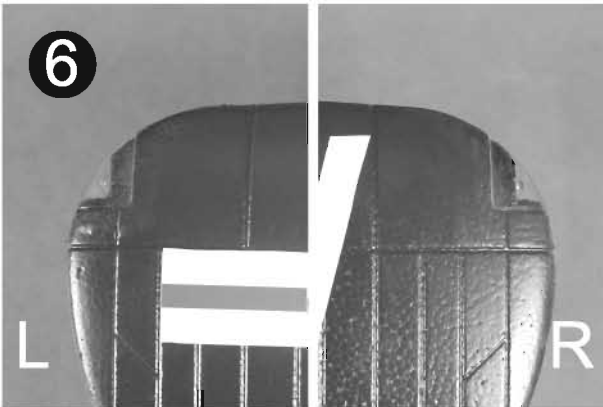

7. Stick Input the aileron to make sure the servos functions well. Put the Z-bend end of the linkage into the desired servo control horn hole of the main-wing. It is a tight fit and should allow the linkage to move just slightly within the hole to avoid binding up.

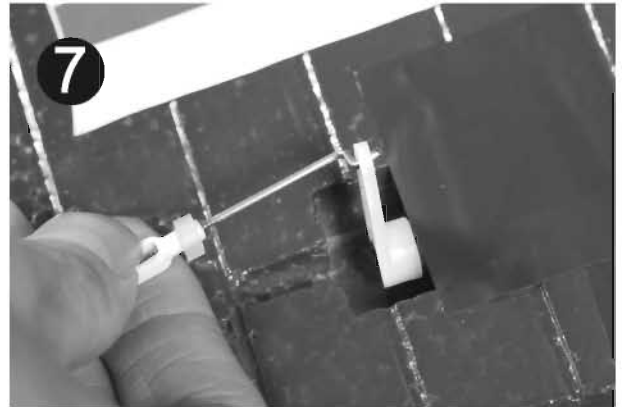

8. Slap the clevis into the surface control horn.

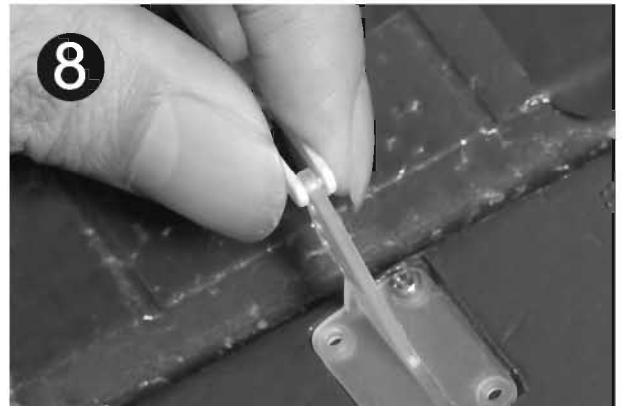

9. The provided piece of fuel tubing keeps the clevis closed during flight. Do all the linkages the same way in the model building process.



Test the main wing electric device

10. Toggle switch the flaps channel knob according to which port the Y harness you have inserted into the receiver.
Note: To avoid the “buzz” sound from the flap servos caused by the flap jam with the wing trailing edge, install either the flaps linkage while the servo arm in up position. And make sure the trailing edge of the flaps level with the wing root.



Mount the main wing

5. Mount the wing to the fuselage by fitting the foamy nose into the groove in front of the wing bay.

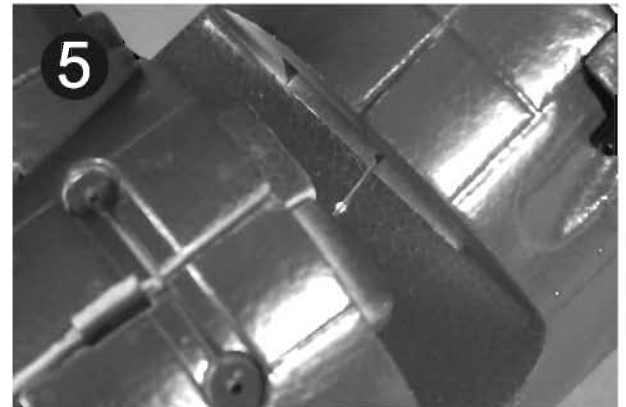

6. Guide the cables from the wing panels through the hole in the bottom of the fuselage wing bay. Put the wing into place and gently pull the cables from inside of the canopy simultaneously to avoid any tangling of the cables.

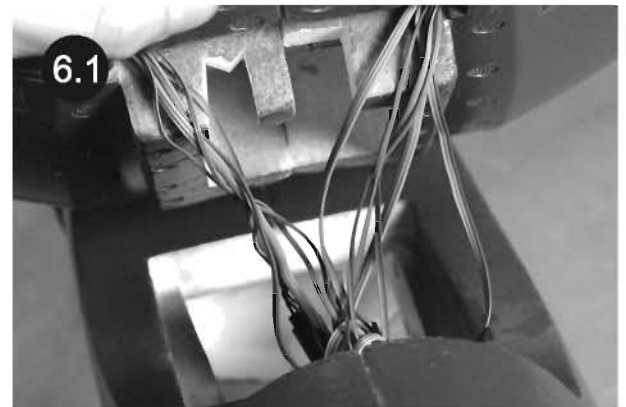

Install the stabilizer

7. Fit the main wing securing plate into place.



8. Secure the main wing bolt plate using the provided machine screws.
(The rear end screws **A: PM 3.0X50 2PCS**,
B: PM 3.0X75 2PCS)

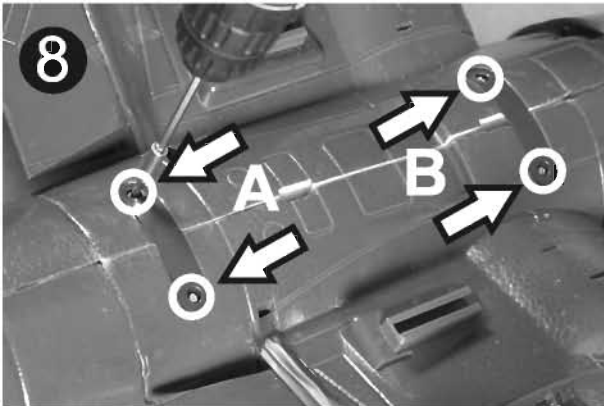

1. Fix the horizontal stabilizer into place with the washer side face up, secure it into place using the provided self tapping screws, Make sure it fully seated into place. **(PA2.6*20 2PCS)**

Note: Do not over tighten the screw, but make sure it's tight enough.

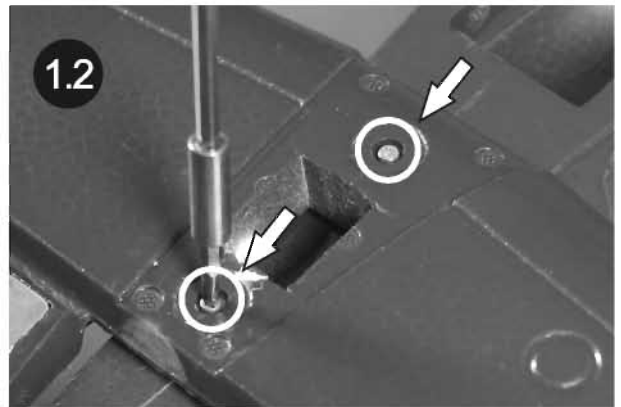

2. Insert the foamy nose in front of the vertical stabilizer into the slot as the picture shows. make sure to insert the foam nose on bottom of the vertical stabilizer into the hole on top of the horizontal stabilizer.

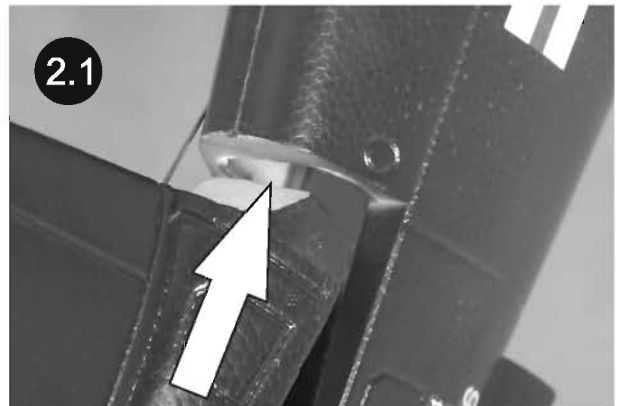

Disassemble the rear landing gear

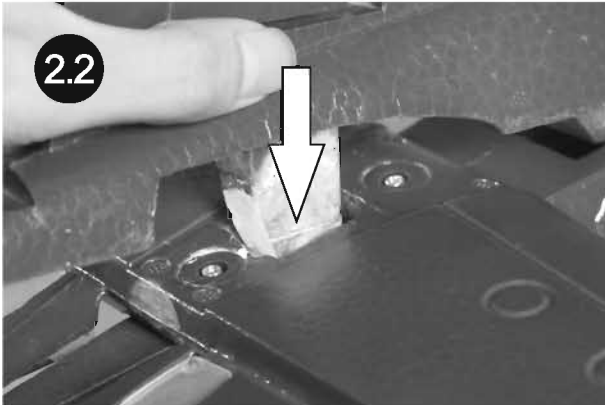

3. Turn over the plane so the bottom of the plane face up, secure the stabilizer into place using the provided self tapping screws. **(PA 2.6*25 1PCS)**
 Note: Make sure the vertical stabilizer fully fitted into place.

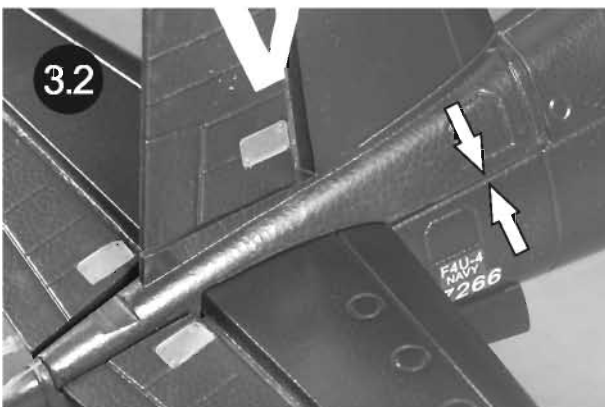

1. Unscrew the four screws that hold the gear into place.

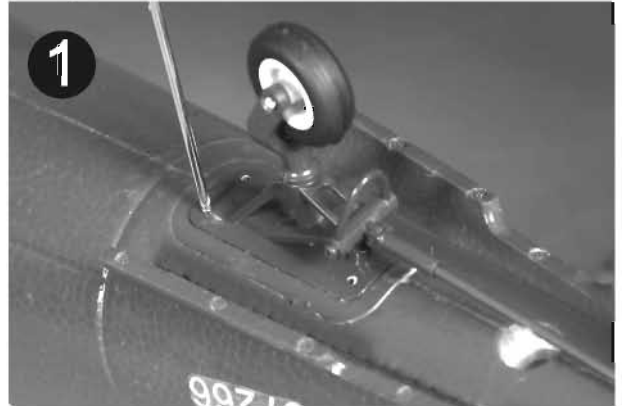

2. Pull out the assembly out a little and then slide it forward.

Note: Do not force the assembly further than it will slide,



3. Rotate the assembly counter clockwise 90 degrees and pull out the assembly.



step6

Install the stabilizer

4. Insert the Z bend end of the linkage rod from the top of the steering arm when install the assembly. Repeat those steps in reverse to install the assembly back. Note: Be sure to insert the linkage into the control connector before fully fit the landing gear assembly into place.

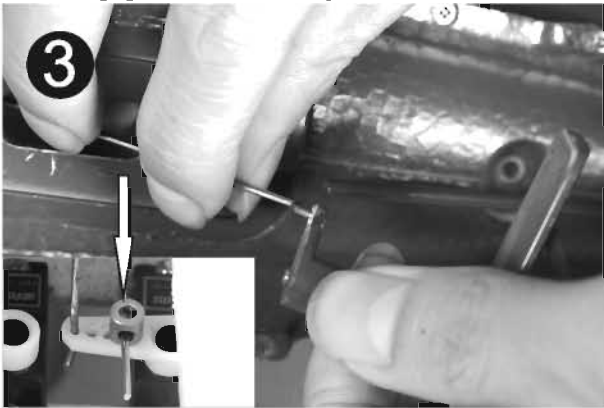

Important ESC information

1. The ESC included with the F4U has a safe start. If the motor battery is connected to the ESC and the throttle stick is not in the low throttle or off position, the motor will not start until the throttle stick is moved to the low throttle or off position. Once the throttle stick is moved to the low throttle or off position, the motor will emit a series of beeps. Several beeps with the same tune means the ESC has detect the cells of the battery. The count of the beeps equal the cells of the battery. The motor is now armed and will start when the throttle is moved.
2. The motor and ESC come pre-connected and the motor rotation should be correct. If for any reason the motor is rotating in the wrong direction, simply reverse two of the three motor wires to change the direction of rotation.

3. The motor has an optional brake setting. The ESC comes with the brake switched off and we recommended that the F4U be flown with the brake off . However, the brake could be accidentally switched on if the motor battery is connected to the ESC while the throttle stick is set at full throttle. To switch the brake off, move the throttle stick to full throttle and plug in the motor battery. The motor will beep one time. Move the throttle stick to low throttle or the off position. The motor is ready to run and the brake will be switched off.
4. Battery Selection and Installation. We recommend the 14.8V 2600mAh 25C(270g/9.5oz) Li-Po battery. If using another battery, the battery must be at least a 14.8V 2600mAh 25C battery. Your battery should be approximately the same capacity ,dimension and weight as the 14.8V 2600mAh 25C Li-Po battery to fit in the fuselage without changing the center of gravity significantly.
5. No beeps from the Motor, you need to calibrate the throttle or restore the factory setup defaults.
How to calibrate:
 1. Power on your Transmitter
 2. Set the Throttle stick all the way up to a 100%
 3. Power on your aircraft.
 4. Wait about 2 seconds in and you will hear 1 beep, immediately after the first beep, bring your throttle stick all the way down to 0%.
 5. You will hear a single initializing beep.
 6. Power down you Aircraft then Transmitter.
 7. Power on your Transmitter first then the Aircraft and you should be all set.**How to restore:** Repeat the **How to calibrate** setting, but the restoring step holds more audible tone accounts, please refers to **ESC manual** to set the ESC, every signal means a tone in the manual. For example, the mark “ * _ _ _ * ” means a tone. When you here the forth tone in the restore step, bring your throttle stick all the way down to 0%.
Caution: If you try to weld a new connecter 3.5 Golden plug, XT 60 or a Dean plug. Please refers to the polarity on your battery and make sure you do not weld the connector pole in reverse, or the short circuit will ruins your battery and the ESC.











The control system testing

Before getting started, plug the receiver and rebind your receiver with your transmitter is necessary according the binding status of your receiver and the transmitter.

CAUTION: To prevent personal injury, DO NOT install the propeller assembly onto the motor shaft while testing the control surfaces . DO NOT arm the ESC and do not turn on the transmitter until the **Transmitter Manual** instructs you to do so.

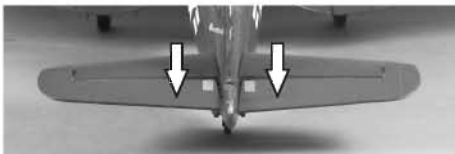
Tips: Make sure all control sticks on your radio are in the neutral position (rudder, elevator, ailerons) and the throttle in the OFF position. Make sure both ailerons move up and down (travel) the same amount. This model tracks well when the left and right ailerons travel the same amount in response to the control stick.

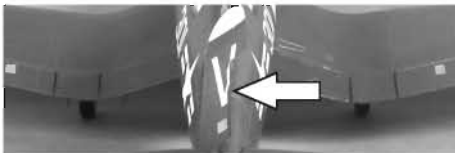
1. Move the controls on the transmitter to make sure aircraft control surface move correctly. See diagrams below. If controls respond in the opposite direction reverse the direction for operation of flight controls. Refer to your transmitter's instructions for changing direction of transmitter flight controls.

	Bank Left		Aileron
	Bank Right		
	Climb		Elevator
	Descend		
	Yaw Left		Rudder/ Steering
	Yaw Right		

The control system testing

- Adjust the servo arms mechanically make sure all servo arms are fully vertical. If not, adjust the servo arm by using the trim function on your radio.
Note: For computerized transmitters, use the servo/channel sub-trim feature to make each servo arm fully vertical. Make sure the trims and the sub trims in neutral position before making some mechanically trim.
- The standard hole settings for linkage connections are shown by the black arrows in the the diagram below. You can refer the recommended control throw setting to move the linkage to different hole positions to increase control surface travel and increase the aerobatics of the airplane. For the computerized transmitter, please refers to the **Low and High rate** setting for more accurate control throw setting.

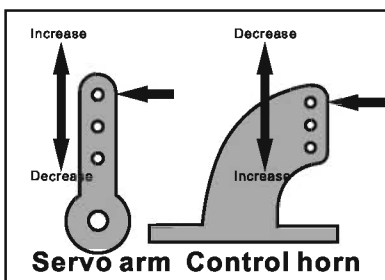

	High rate	Low rate
Elevator -	25mm/1.0in up and down	15mm/0.6in up and down
Rudder -	25mm/0.98in left and right	21mm/0.8in left and right
Ailerons -	28mm/1.1in up and down	17mm/0.7in up and down
Flaps -	Mid 22mm/0.9in	
	Full 45mm/1.8in	

- Align the slotted flaps control surfaces well with the wing root by turning the clevis clockwise and counterclockwise on the linkage rod while the flaps in up position. The aileron align with the flaps.

Note: Secure the clevis using the securing tube after the alignment of the surface is completed.



- Align the elevator control surfaces well by adjusting the linkage in the control connector. The counter balance leading edge of the elevator level with the trailing edge of the stabilizer.

Note: Use a drop of thread lock on the grub screws before securing the linkage rod.

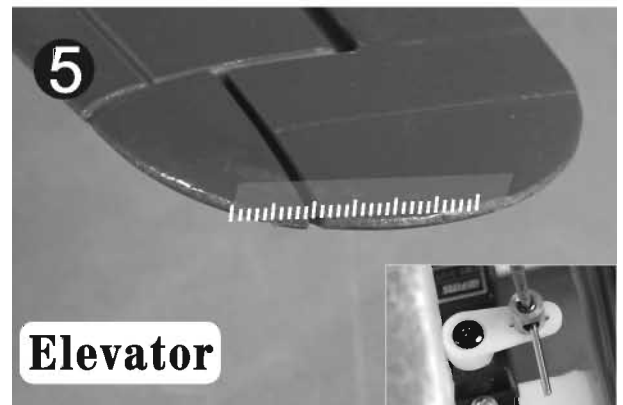

- Align the tail wheel with the fuselage centerline by adjusting the linkage rod in the cockpit area. Repeat the **Step 4** to align the rudder with the vertical fin.



The control system testing

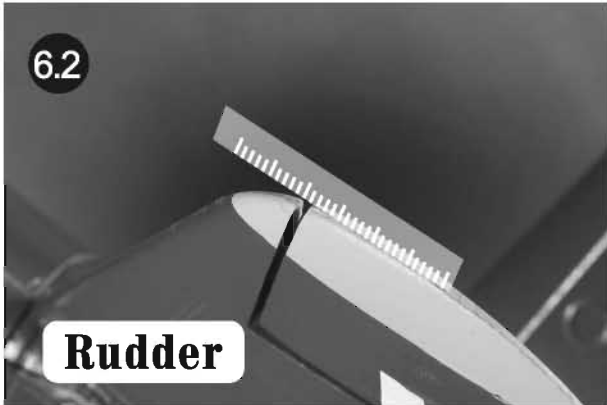

7. Test the motor make sure it is responsive to the throttle input and rotate the counter clock wise from the tail view, or you have to reset the transmitter.



Install the propeller blade

1. The propeller and the spinner kit.



2. Fit the propeller blades to the backplate of the hub with the decal side face up. **Note:** The hub center of the backplate contain a hex notch.

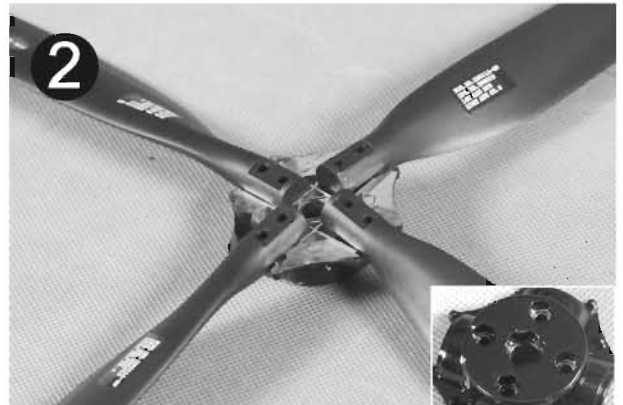

3. Place the front plate of the hub into place.



4. Snap the hub to make sure the hub halves fully hold into place.



step8

Install the propeller assembly

CAUTION: Before testing the propeller, make sure the tail of the plane is firmly on the ground and ensure there are no people or objects in the range of the propeller. Make sure the throttle stick and the trim on the lowest position before plug in the battery.

1. Place two Nylon Insert Lock Nuts rightly into the hex notch on bottom of the spinner back plate.

Note: Always hold the nuts into place in the process of the blades mounting.



2. Secure the hub using the machine screws in stored with hub.



3. Verify the completed propeller set installation.

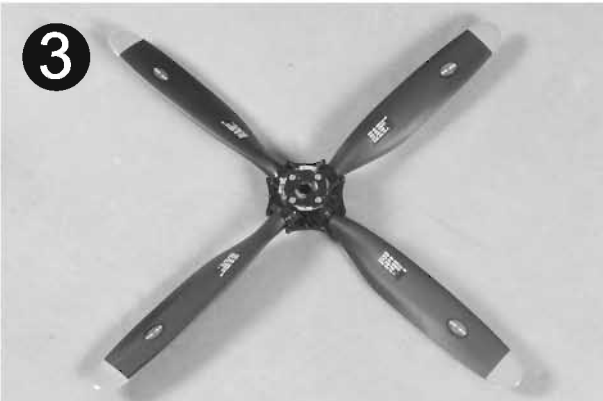

4. Keyed the propeller assembly to the motor shaft, make sure to fit the assembly into the hex nut on the shaft, it will help to hold the assembly in fixed position when the engine contacted.



5. Hand tighten the spinner and make sure it is tight enough.



Install the accessory parts of the plane

1. Attach the receiver to the hatch in bottom of the canopy bay as the picture shows.



2. The battery position.



3. Disassemble the faring plate at the bottom of the main wing.

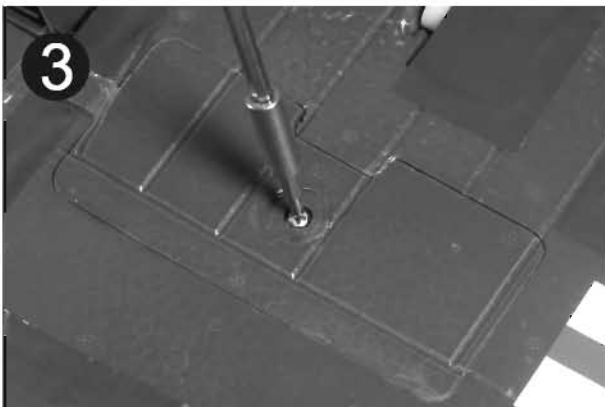

4. Rise the plate by holding the tape on one end of the plate.

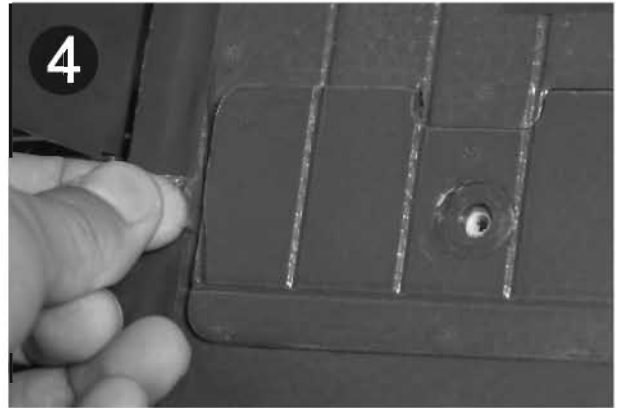

5. Install the proper rocket mounting rail into place and secure it.

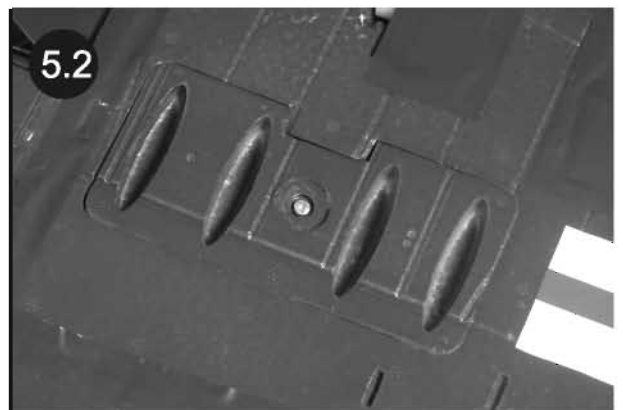
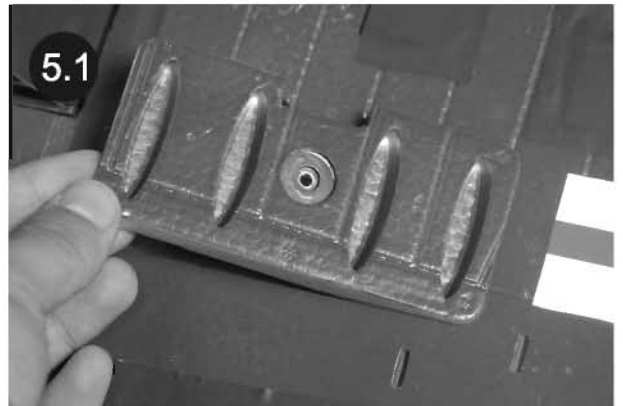

step9

Install the accessory parts of the plane

6. Glue the rockets into place.
Tips: We do not recommended to install the rockets and the oil tanks for the aerobatic flying experience.

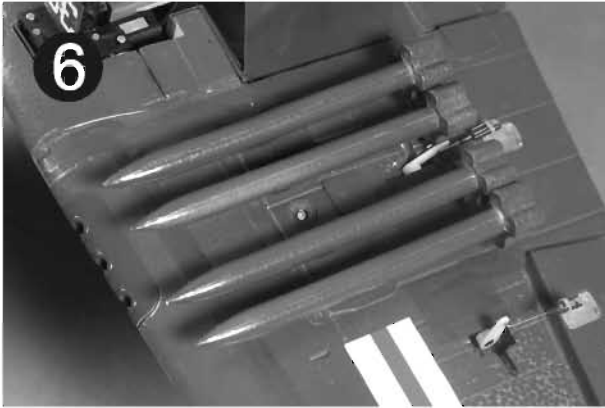

7. Slide the oil tanks into the tanks rack , two tanks are the same, you can take any one of them to hang on a rack.

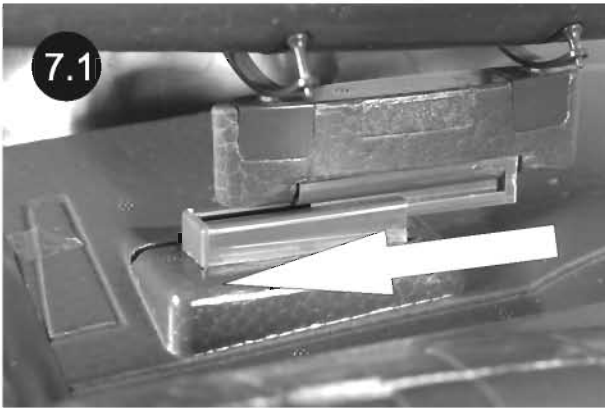

8. Glue the antenna mast into place as the picture shows.



9. Glue the air speed head onto the bottom of the port side wing tip.

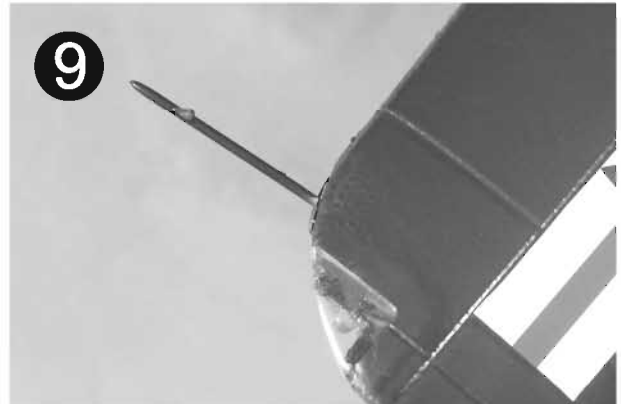

Check the C.G. (Center of Gravity)

Center of Gravity

When balancing your model, adjust the motor battery as necessary so the model is level or slightly nose down. This is the correct balance point for your model. After the first flights, the **CG** position can be adjusted for your personal preference.

1. The recommended Center of Gravity (**CG**) location for your model is **(110mm/4.3in)** forward from the leading edge of the main wing (as shown) with the battery pack installed. Mark the location of the **CG** on top of the wing.

2. When balancing your model, support the plane at the marks made on the bottom of the main wing with your fingers or a commercially available balancing stand. This is the correct balance point for your model. Make sure the model is assembled and ready for flight before balancing.

3. Always balance the plane with the retracts down.

Caution: Do not connect the battery to the ESC while balancing the plane. Always balance the plane with the retract down.

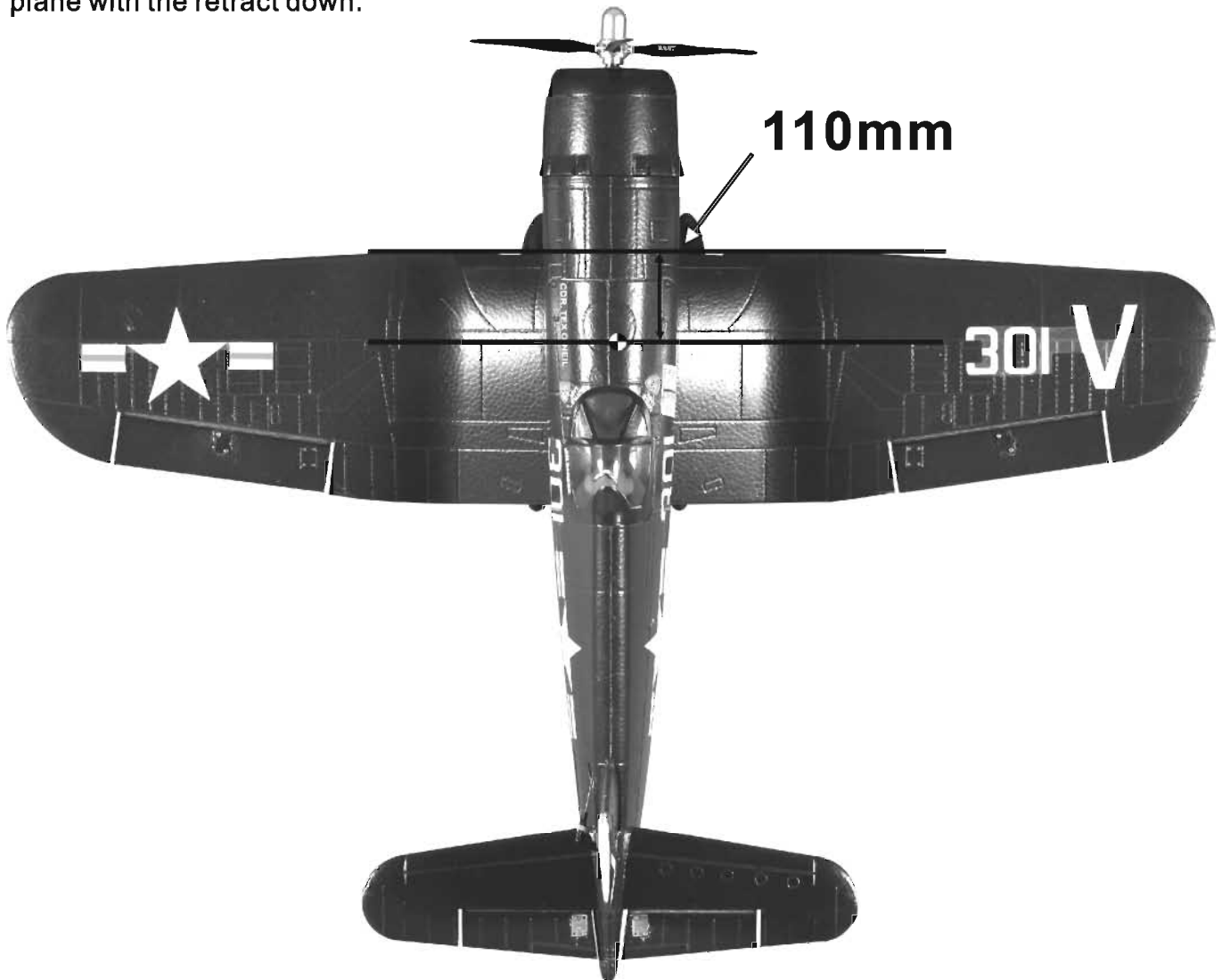

step 11

Ready to fly

Find a suitable flying site

Find a flying site clear of buildings, trees, power lines and other obstructions. Until you know how much area will be required and have mastered flying your plane in confined spaces, choose a site which is at least the size of two to three football fields – a flying field specifically for R/C planes is best. Never fly near people– especially children who can wander unpredictably.

Perform the range check of your plane

As a precaution, an operational ground range test should be performed before the first flight each time you go out. Performing a range test is a good way to detect problems that could cause loss of control such as low batteries, defective or damaged radio components, or radio interference. This usually requires an assistant and should be done at the actual flying site you will be using.

First turn on the transmitter, then install a fully-charged battery into the fuselage. Connect the battery and install the hatch.

Remember, use care not to bump the throttle stick, otherwise, the propeller / fan will turn and possibly cause damage or injury.

Note: Please refer to your **Transmitter Manual** that came with your radio control system to perform a ground range check. If the controls are not working correctly or if anything seems wrong, do not fly the model until you correct the problem. Make certain all the servo wires are securely connected to the receiver and the transmitter batteries have a good connection.

Monitor your flight time

Monitor and limit your flight time using a timer (such as one on a wrist watch or in your transmitter if available). When the batteries are getting low you will usually notice a performance drop before the ESC cuts off motor power, so when the plane starts flying slower you should land. Often (but not always) power can be briefly restored after the motor cuts off by holding the throttle stick all the way down for a few seconds.

To avoid an unexpected dead-stick landing on your first flight, set your timer to a conservative 4 minutes. When your alarm sounds you should land right away.

Flying course

Take off

While applying power slowly steer to keep the model straight, the model should accelerate quickly. As the model gains flight speed, you will want to climb at a steady and even rate. The **F4U** will climb out at a nice angle of attack (AOA).

Flying

Always choose a wide-open space for flying your plane. It is ideal for you to fly at a sanctioned flying field. If you are not flying at an approved site, always avoid flying near houses, trees, wires and buildings. You should also be careful to avoid flying in areas where there are many people, such as busy parks, schoolyards, or soccer fields. Consult laws and ordinances before choosing a location to fly your aircraft. After takeoff, gain some altitude. Climb to a safe altitude and begin to trim the model till it's tracks well through all aspects of flight, including high speed passes, inverted flight, loops, and point rolls.

Landing

Land the model when you hear the motor pulsing (LVC) or if you notice a reduction in power. If using a transmitter with a timer, set the timer so you have enough flight time to make several landing approaches.

Recharge the battery and repair the model as needed. The model's three point landing gear allows the model to land on hard surfaces. Align model directly into the wind and fly down to the ground. Fly the airplane down to the ground using 1/4-1/3 throttle to keep enough energy for proper flare. Before the model touches down, always fully decrease the throttle to avoid damaging the propeller or other components. The key to a great landing is to manage the power and elevator all the way to the ground and set down lightly on the main landing gear. After a few flights you will find the model can be set down lightly on the mains and you can hold the nose wheel off balancing the model on the mains till it slows and gently settles the tail.

Maintenance

Repairs to the foam should be made with foam safe adhesives such as hot glue, foam safe CA, and 5 min epoxy. When parts are not repairable, see the Spare Parts List for ordering by item number.

Always check to make sure all screws on the aircraft are tightened. Pay special attention to make sure the bullet of the rotor adaptor is firmly in place before every flight.

Main specification and spare parts

Specification

Wing span: 1400mm/55.6in

Length: 1240mm/49.0in

Motor : 4250-KV540

ESC : 70A with 5A SBEC

Battery : 14.8V 2600mAh 25C

Servo : 17g*6, 9g*2

Approx flying weight: 2440g

Propeller: 14*8 four blades scale propeller

Wing area: 38.7dm²

Wing loading: 63.0 g/dm²

The recommended TX &RX system: 6CH
at least

Spare parts list for F4U

Item# Description

- SV-101 Fuselage
- SV-102 Main wing (A pair of wing with the gear base installed)
- SV-103 Vertical stabilizer
- SV-104 Horizontal stabilizer
- SV-105 NACA cowling part 1 (The foamy cowling)
- SV-106 Cockpit (Foam cockpit hatch and Plastic canopy and Pilot)
- SV-107 Oil tank (A pair of identical oil tank)
- SV-108 Rocket set (8 pieces)
- SV-109 Motor (4250-KV540)
- SV-110 Battery (14.8V 2600mAh 25C)
- SV-111 ESC (70A with 5A SBEC)
- SV-112 9g servo/**Positive** (**Positive** for starboard of main landing gear doors)
- SV-113 9g servo/**Reverse** (**Reverse** for port side of main landing gear doors)
- SV-114 17g servo (For all the control surface: Elevator, Rudder, Ailerons, Flaps)
- SV-115 Propeller (Four pieces blade)
- SV-116 Sequencer (For the landing gear system)
- SV-117 Main landing gear system (A pair of retracts with strut and wheel installed)
- SV-118 E-Retract (A pair of electric retracts)
- SV-119 Main landing gear strut (A pair of strut with tires)
- SV-120 Tire set (Tricycle tire set)
- SV-121 Motor board
- SV-122 Spinner
- SV-123 Main landing gear fairing door (A pair of main landing gear fairing door)
- SV-124 NACA cowling part 2 (The plastic cowling)
- SV-125 Rear landing gear system
- SV-126 Motor shaft
- SV-127 X motor base
- SV-128 Linkage rod
- SV-129 Screw set
- SV-130 Decal sheet

Note: All spare parts without decals are applied.

Spare Parts List for The plane



SV-101

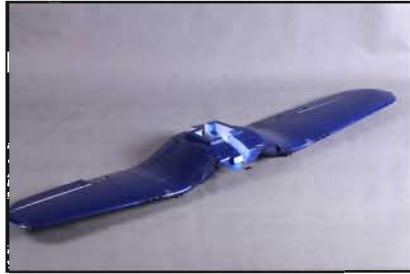

SV-102



SV-103



SV-104



SV-105



SV-106



SV-107

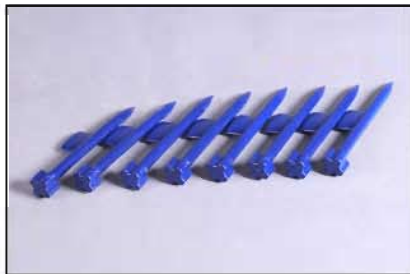

SV-108



SV-109



SV-110



SV-111



SV-112



SV-113



SV-114



SV-115

Spare Parts List for Shangri-la Scheme

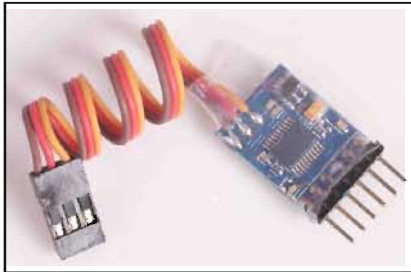

SV-116

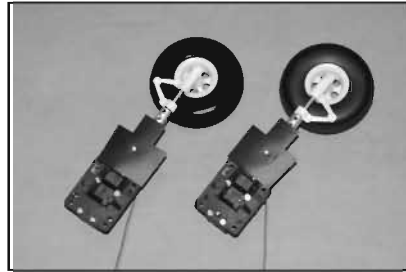

SV-117

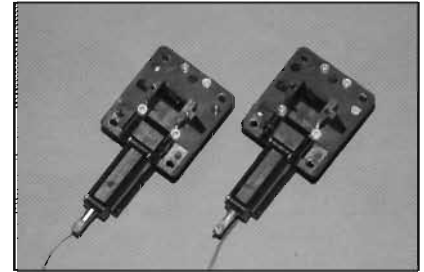

SV-118



SV-119



SV-120



SV-121

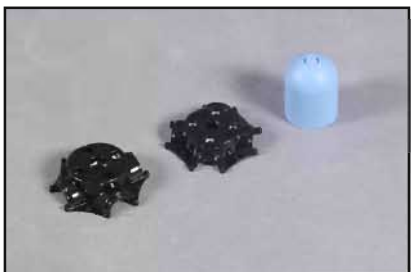

SV-122

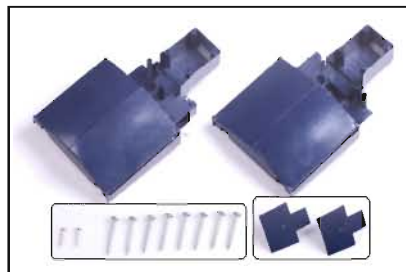

SV-123



SV-124



SV-125



SV-126



SV-127



SV-128



SV-129

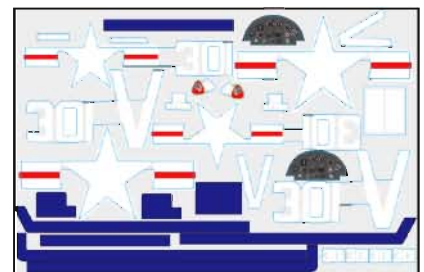

SV-130

Troubleshooting

Problem	Possible Cause	Solution
Aircraft will not respond to the throttle but responds to other controls.	<ul style="list-style-type: none"> - ESC is not armed. - Throttle channel is reversed. 	<ul style="list-style-type: none"> - Lower throttle stick and throttle trim to lowest settings. - Reverse throttle channel on transmitter.
Extra propeller noise or extra Vibration.	<ul style="list-style-type: none"> - Damaged spinner, propeller, motor, or motor mount. - Loose propeller and spinner parts. - Propellor installed backwards. 	<ul style="list-style-type: none"> - Replace damaged parts. - Tighten parts for propeller adapter, propeller and spinner.
Reduced flight time or aircraft underpowered.	<ul style="list-style-type: none"> - Flight battery charge is low. - Propeller installed backward. - Flight battery damaged. 	<ul style="list-style-type: none"> - Remove and install propeller correctly. - Completely recharge flight battery. - Replace flight battery and obey flight battery instructions.
Control surface does not move, or is slow to respond to control inputs.	<ul style="list-style-type: none"> - Control surface, control horn, linkage or servo damage. - Wire damaged or connections loose. 	<ul style="list-style-type: none"> - Replace or repair damaged parts and adjust controls. - Do a check of connections for loose wiring.
Controls reversed.	Channels are reversed in the transmitter.	Do the Control Direction Test and adjust controls for aircraft and transmitter.
<ul style="list-style-type: none"> - Motor loses power. - Motor power pulses then motor loses power. 	<ul style="list-style-type: none"> - Damage to motor, or battery. - Loss of power to aircraft. - ESC uses default soft Low Voltage Cutoff(LVC). 	<ul style="list-style-type: none"> - Do a check of batteries, transmitter, receiver, ESC, motor and wiring for damage (replace as needed). - Land aircraft immediately and Recharge flight battery.
LED on receiver flashes slowly.	Power loss to receiver.	<ul style="list-style-type: none"> - Check connection from ESC to receiver. - Check servos for damage. - Check linkages for binding.

AMA

If you are not already a member of the AMA, please join, The AMA is the governing body of model aviation and membership provided liability insurance coverage, protects modelers' rights and interests and is required to fly at most R/C sites.

Academy of Model Aeronautics

5151 East Memorial Drive

Muncie, IN 47302-9252

Ph.(800)435-9262

Fax(765)741-0057

Or via the Internet at: <http://www.modelaircraft.org>



Academy of Model Aeronautics National Model Aircraft Safety Code Effective January 1, 2011

- A. GENERAL:** A model aircraft is a non-human-carrying aircraft capable of sustained flight in the atmosphere. It may not exceed limitations of this code and is intended exclusively for sport, recreation and/or competition.
All model flights must be conducted in accordance with this safety code and any additional rules specific to the flying site.
1. Model aircraft will not be flown:
 - (a) In a careless or reckless manner.
 - (b) At a location where model aircraft activities are prohibited.
 2. Model aircraft pilots will:
 - (a) Yield the right of way to all man carrying aircraft.
 - (b) See and avoid all aircraft and a spotter must be used when appropriate.
(AMA Document #540-D-See and Avoid Guidance.)
 - (c) Not fly higher than approximately 400 feet above ground level within three (3) miles of an airport, without notifying the airport operator.
 - (d) Not interfere with operations and traffic patterns at any airport, heliport or seaplane base except where there is a mixed use agreement.
 - (e) Ensure the aircraft is identified with the name and address or AMA number of the owner on the inside or affixed to the outside of the model aircraft.
(This does not apply to model aircraft flown indoors).
 - (f) Not operate aircraft with metal-blade propellers or with gaseous boosts except for helicopters operated under the provisions of AMA Document #555.
 - (g) Not operate model aircraft while under the influence of alcohol or while using any drug which could adversely affect the pilot's ability to safely control the model.
 - (h) Not operate model aircraft carrying pyrotechnic devices which explode or burn, or any device which propels a projectile or drops any object that creates a hazard to persons or property.

Exceptions:

- ◆ Free Flight fuses or devices that burn producing smoke and are securely attached to the model aircraft during flight.
 - ◆ Officially designated AMA Air Show Teams (AST) are authorized to use devices and practices as defined within the Team AMA Program Document (AMA Document #718).
3. Model aircraft will not be flown in AMA sanctioned events, air shows or model demonstrations unless:
 - (a) The aircraft, control system and pilot skills have successfully demonstrated all maneuvers intended or anticipated prior to the specific event.
 - (b) An inexperienced pilot is assisted by an experienced pilot.
 4. When and where required by rule, helmets must be properly worn and fastened. They must be OSHA, DOT, ANSI, SNELL or NOCSAE approved or comply with comparable standards.

B. RADIO CONTROL (RC)

1. All pilots shall avoid flying directly over unprotected people, vessels, vehicles or structures and shall avoid endangerment of life and property of others.
2. A successful radio equipment ground-range check in accordance with manufacturer's recommendations will be completed before the first flight of a new or repaired model aircraft.
3. RC model aircraft must use the radio-control frequencies currently allowed by the Federal Communications Commission (FCC). Only individuals properly licensed by the FCC are authorized to operate equipment on Amateur Band frequencies.
4. RC model aircraft will not operate within three (3) miles of any pre-existing flying site without a frequency-management agreement (AMA Documents #922-Testing for RF Interference; #923- Frequency Management Agreement)
5. With the exception of events flown under official AMA Competition Regulations, excluding takeoff and landing, no powered model may be flown outdoors closer than 25 feet to any individual, except for the pilot and the pilot's helper(s) located at the flight line.
6. Under no circumstances may a pilot or other person touch a model aircraft in flight while it is still under power, except to divert it from striking an individual. This does not apply to model aircraft flown indoors.
7. RC night flying requires a lighting system providing the pilot with a clear view of the model's attitude and orientation at all times.
8. The pilot of a RC model aircraft shall:
 - (a) Maintain control during the entire flight, maintaining visual contact without enhancement other than by corrective lenses prescribed for the pilot.
 - (b) Fly using the assistance of a camera or First-Person View (FPV) only in accordance with the procedures outlined in AMA Document #550.

C. FREE FLIGHT

1. Must be at least 100 feet downwind of spectators and automobile parking when the model aircraft is launched.
2. Launch area must be clear of all individuals except mechanics, officials, and other fliers.
3. An effective device will be used to extinguish any fuse on the model aircraft after the fuse has completed its function.



[Http:// www.fmsmodel.com](http://www.fmsmodel.com)
Email: info@fmsmodel.com