



DX5 Pro

5-Channel 2.4GHz DSMR® Radio System



Instruction Manual
Bedienungsanleitung
Manuel d'utilisation
Manuale di istruzioni

NOTICE: All instructions, warranties and other collateral documents are subject to change at the sole discretion of Horizon Hobby, LLC. For up-to-date product literature, visit horizonhobby.com and click on the support tab for this Product.

Meaning of Special Language

The following terms are used throughout the product literature to indicate various levels of potential harm when operating this product:

WARNING: Procedures, which if not properly followed, create the probability of property damage, collateral damage and serious injury OR create a high probability of superficial injury.

CAUTION: Procedures, which if not properly followed, create the probability of physical property damage AND a possibility of serious injury.

NOTICE: Procedures, which if not properly followed, create a possibility of physical property damage AND little or no possibility of injury.



WARNING: Read the ENTIRE instruction manual to become familiar with the features of the product before operating.

Failure to operate the product correctly can result in damage to the product, personal property and cause serious injury.

This is a sophisticated hobby product. It must be operated with caution and common sense and requires some basic mechanical ability. Failure to operate this product in a safe and responsible manner could result in injury or damage to the product or other property. This product is not intended for use by children without direct adult supervision. Do not attempt disassembly, use with incompatible components or augment product in any way without the approval of Horizon Hobby, LLC. This manual contains instructions for safety, operation and maintenance. It is essential to read and follow all the instructions and warnings in the manual, prior to assembly, setup or use, in order to operate correctly and avoid damage or serious injury.



WARNING AGAINST COUNTERFEIT PRODUCTS

Always purchase from a Horizon Hobby, LLC authorized dealer to ensure authentic high-quality Spektrum product. Horizon Hobby, LLC disclaims all support and warranty with regards, but not limited to, compatibility and performance of counterfeit products or products claiming compatibility with DSM or Spektrum technology.

NOTICE: This product is only intended for use with unmanned, hobby-grade, remote-controlled vehicles and aircraft. Horizon Hobby disclaims all liability outside of the intended purpose and will not provide warranty service related thereto.

Age Recommendation: Not for Children under 14 years. This is not a toy.

Warranty Registration

Visit community.spektrumrc.com today to register your product.

SAFETY PRECAUTIONS

- Always ensure all batteries have been properly charged prior to using the model.
- Always check all servos and their connections prior to each run.
- Never operate your model near spectators, parking areas or any other area that could result in injury to people or damage of property.
- Never operate your model during adverse weather conditions. Poor visibility can cause disorientation and loss of control of your model.
- Never point the transmitter antenna directly toward the model. The radiation pattern from the tip of the antenna is inherently low.
- If at any time during the operation of your model you observe any erratic or abnormal operation, immediately stop operation of your model until the cause of the problem has been ascertained and corrected.

TABLE OF CONTENTS

Identifying Controls and Switches	4	Telemetry.....	16
Main Screen	4	Drive Mode.....	17
Installing Batteries	4	Lap Timer.....	17
Micro SD-Card	5	System Settings	18
Registering the Transmitter	5	Display.....	18
Updating Raceware™ Software	6	Trims.....	19
Navigation	7	Sound settings.....	19
Function List	8	About.....	19
Model Select, Pre-Loaded Model Setups.....	8	Calibrate.....	19
Model Name.....	8	Model Select.....	20
Servo Setup.....	8	Model Utilities.....	20
Travel.....	8	System Setup	21
Sub-Trim.....	9	Create new model.....	21
Reverse.....	9	Delete Model.....	21
Speed.....	9	Model Copy.....	21
Rates.....	9	Reset Model.....	21
Exponential.....	10	Sort Model List.....	22
Timer.....	10	Transfer sd card.....	22
Frame Rate:.....	10	Physical Transmitter Adjustments	23
Failsafe.....	10	Changing grips.....	23
Binding.....	11	Dropdown steering wheel options.....	24
Mixing.....	11	Standard wheel conversion:.....	24
AVC Programming Menu.....	13	Steering Wheel Wedges.....	24
AVC Tuning (AVC Receiver not included).....	14	SR2100 Receiver	25
Automatic Braking System (ABS).....	15	Optional Lithium Battery	26
Idle Up.....	15	Troubleshooting Guide	27
Traction.....	15	Optional parts list	27
Trim setup.....	15	FCC Information	29
Trim Assign.....	16	IC Information	29
Aux Assign.....	16	Compliance Information for the European Union	29

SPECIFICATIONS

DX5 PRO	
Type	Pistol Grip Transmitter
Channels	5
Frequency	2405 – 2476 MHz
Power output (EIRP)	≤ 20 dBm
Input Voltage	4-8.4V, 4 AA alkaline batteries included
Compatibility	DSM2 and DSMR
SD Card Compatible	Micro SD Card, not included

GETTING STARTED

(SR2100 Receiver)

1. Install batteries in transmitter
2. Insert bind plug in receiver and then turn on vehicle
3. Turn the transmitter on and put it in bind mode
4. Set up servo reverse, travel, and sub trim
5. Re-bind to set proper failsafe positions

DAILY DRIVING

1. Turn on transmitter first
2. Turn on vehicle
3. Turn off vehicle first
4. Turn off transmitter

IDENTIFYING CONTROLS AND SWITCHES

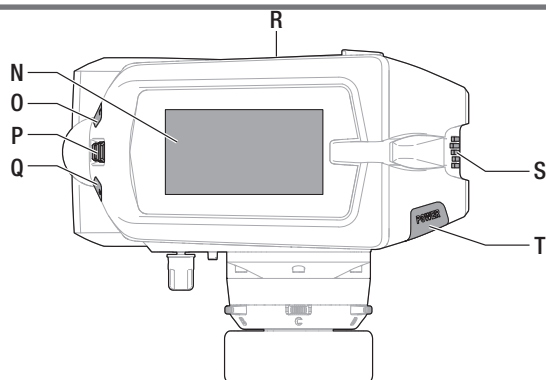
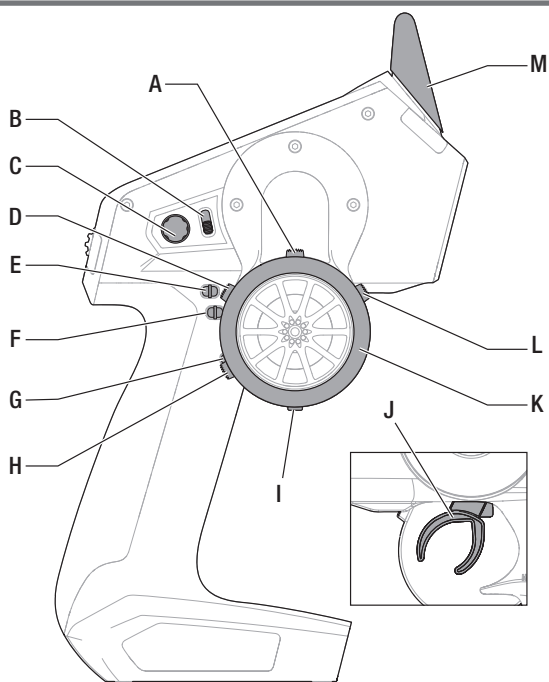

- | | |
|-----------------------------|-------------------|
| A: Button C | K: Steering Wheel |
| B: Switch I | L: Button D |
| C: Knob | M: Antenna |
| D: Button B | N: LCD Screen |
| E: Button F | O: Button L |
| F: Button G | P: Roller Wheel |
| G: Button H | Q: Button R |
| H: Button A | R: SD Card Reader |
| I: Button E | S: Power LED |
| J: Trigger (throttle/brake) | T: Power Button |

MAIN SCREEN

The Main Screen displays information about the active model, including the Timer (when activated). To return to the Main Screen at any time, press and hold the scroll wheel for at least 6 seconds.

- A: Transmitter Battery Voltage
- B: User Name
- C: Model Name
- D: Steering Rate
- E: Timer 1 (when activated)
- F: Timer 2 (when activated)
- G: Position of Steering (STR) trim
- H: Position of Throttle (THR) trim
- I: Position of Brake (BRK) trim
- J: Position of Aux 1 trim
- K: Position of Aux 2 trim
- L: Position of Aux 3 trim

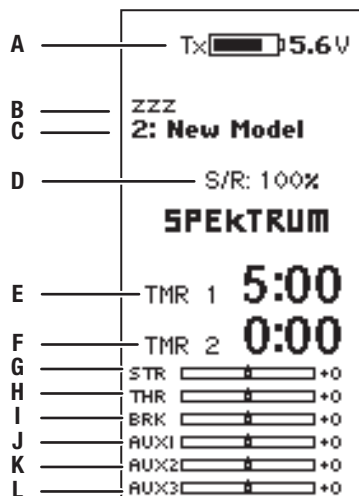

INSTALLING BATTERIES

1. Remove the battery cover from the bottom of the transmitter.
2. Install 4 AA batteries as shown.
3. Install the battery cover.

CAUTION: NEVER remove the transmitter batteries while the model is powered on. Loss of model control, damage or injury may occur.

CAUTION: If using rechargeable batteries, charge only rechargeable batteries. Charging non-rechargeable batteries may cause the batteries to burst, resulting in injury to persons and/or damage to property.

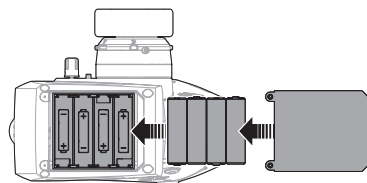

CAUTION: Risk of explosion if battery is replaced by an incorrect type. Dispose of used batteries according to state and local laws.

MICRO SD-CARD*

Installing the Micro SD-Card

A Micro SD-Card (not included) enables drivers to:

- Import (copy) models from any compatible Spektrum™ RaceWare™ transmitter
- Export (transfer) models to any Spektrum RaceWare transmitter
- Update Firmware in the transmitter

To install the Micro SD-Card:

1. Power off the transmitter.
2. Install the Micro SD-Card in the card reader slot located behind the small rubber door on the side of the transmitter.

*For more Micro SD-Card information see the Transfer SD Card section.

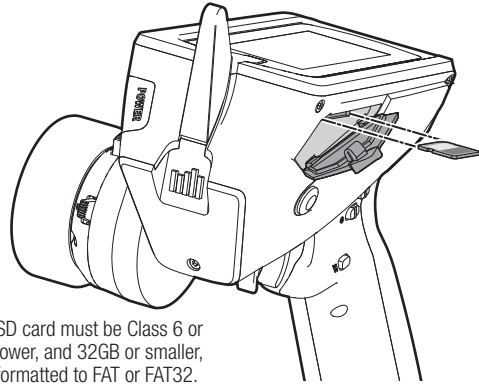

SD card must be Class 6 or lower, and 32GB or smaller, formatted to FAT or FAT32.

REGISTERING THE TRANSMITTER

Exporting the transmitter serial number to the Micro SD-Card allows you to upload the serial number directly into the registration screen at www.spektrumrc.com.

To export the serial number:

1. Install the Micro SD-Card in the card reader slot located behind a small rubber door on the back of the transmitter
2. Click the scroll wheel to enter the FUNCTION LIST.
3. Scroll down to the System Settings menu. Click the scroll wheel once to open the menu.
4. Scroll to About and click the scroll wheel once to open the menu.
5. When the Serial Number screen appears, select EXPORT.
6. Power off the transmitter and remove the Micro SD-Card from the transmitter.



To Upload the serial number to www.spektrumrc.com:

1. Insert the Micro SD-Card in your computer and check the contents of the SD card on your computer for a "My_DX5R.xml" file.
2. In your favorite browser navigate to www.spektrumrc.com and find the Product Registration link on the top of the page as shown.
3. If you do not already have an account, create one now. If you have an account, login in with your secure login.

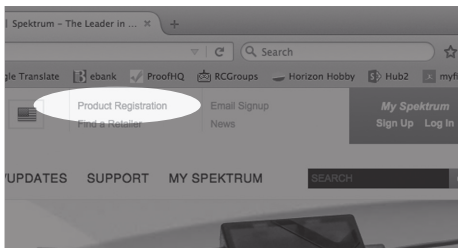

4. Once logged in, go to the "My Spektrum" page. Fill out all relevant information. Once you select your transmitter model from the pull down menu you will be asked to upload the serial number.

5. Click on the Select button to navigate to the "My_DX5R.xml" file on the Micro SD-Card that is in your computer's SD card reader and select the file.
6. Click on the Upload from xml file... button and the serial number will populate into the Serial Number fields.
7. Click Register at the bottom of the screen to finish registering your new Spektrum Transmitter.
8. Alternatively, you can copy the serial number from the .xml file and paste directly into the Serial Number field.

```

<?xml version="1.0" encoding="UTF-8" ?>
<spektrumradio xmlns="http://www.horizonhobby.com/SpektrumTX.xsd"
version="1.0.0.1">
  <model>DX20</model>
  <serial><![CDATA[SSH01BAA4AAAAAAAAAAAAAAAA44LAA]]></serial>
  <version>0.04</version>
</spektrumradio>

```

Screen shots from www.spektrumrc.com are correct at the time of printing but may change at a future date.

UPDATING RACEWARE™ SOFTWARE

NOTICE: The orange LED Spektrum bars flash and a status bar appears on the screen when RaceWare™ software updates are installing. Never power off the transmitter when updates are installing. Doing so may damage the system files.

NOTICE: Before installing any RaceWare files, always Export All Models to an SD Card separate from the SD Card containing the update. The update may erase all model files.

For more information on RaceWare software updates, visit www.spektrumrc.com

Automatically Installing RaceWare Software Updates

1. In your favorite browser navigate to www.spektrumrc.com and find the Firmware Updates link inside the Setups/Updates tab on the top of the page as shown.

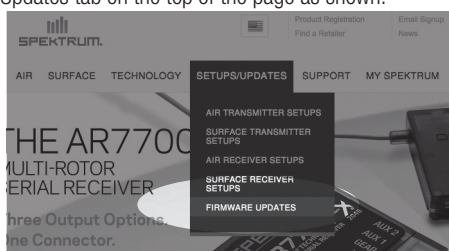

2. Find your registered transmitter in the MY PRODUCTS list and click on Download Updates.

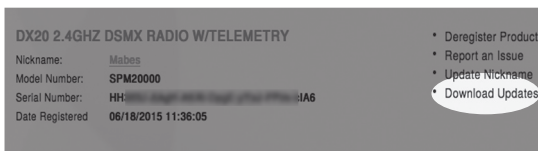

3. Follow directions on the screen for downloading the update to your computer and SD card.

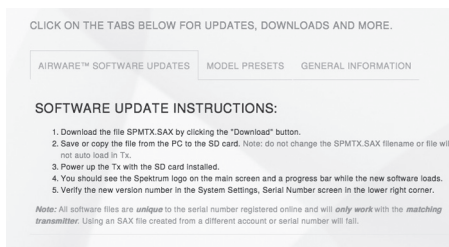

4. Eject the Micro SD Card from the computer.
5. Make sure the transmitter is powered off and install the SD card into the transmitter.
6. Power on the transmitter and the update automatically installs in the transmitter.

Screen shots from www.spektrumrc.com are correct at time of printing but may change at a future date.

Manually Installing RaceWare Software Updates

1. Save the desired RaceWare version to the SD Card.
2. Install the SD card into the transmitter.
3. Select Update Firmware in the SD Card Menu options. The Select File screen appears.
4. Select the desired RaceWare version from the File List. When updates are installing, the transmitter screen is dark. The orange LED Spektrum bars flash and the update status bar appears on the screen.

NOTICE: Do not power off the transmitter when updates are installing. Doing so will damage the transmitter.

NAVIGATION

Using the Scroll Wheel Selector

- Scroll the scroll wheel to move through the screen content or change programming values. Click the scroll wheel to make a selection.
- Use the Back Button to go back to go to the previous screen (for example, to go from the Mixing Screen to the Function List).
- Use the Clear Button to return a selected value on a screen to the default setting.
- The Main Screen appears when you power on the transmitter. Click the scroll wheel once to display the Function List.

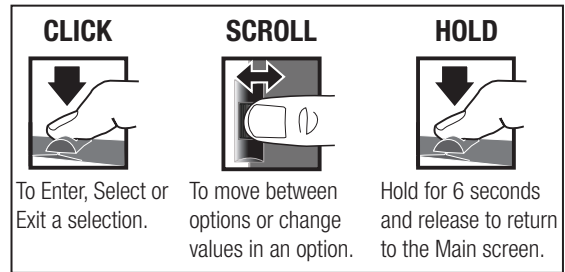

Individual Direction Adjustments

In some instances, you may find it necessary to independently adjust the control directions; for example, if you want more travel for left steering than right steering, perform the following steps:

1. Scroll to the value you wish to change and click the scroll wheel.
2. When both directions are selected, move the control (steering or throttle) toward the control direction you wish to change. The selection box moves to the desired direction. You do not need to hold the control in the desired direction.
3. To change the opposite direction, simply move the control in that direction.
4. Click the scroll wheel to save the selection.

Auto Switch Select

To easily select a switch in a function, such as a program mix, roll with the scroll wheel to highlight the switch selection box, and click the scroll wheel. The box around the switch should now flash. To select a switch, toggle the switch you wish to select. Verify the switch selection is now displayed as desired. When correct, click the scroll wheel to select this switch and complete the switch selection.

Tip: The tick mark below shows the current switch position.

Rolling and clicking the scroll wheel turns the selected box black, indicating that the value or condition will act on that position.

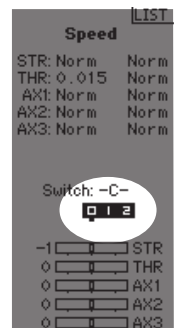

Switch Selection Tip

If the system won't allow INHIBIT to be changed, all switches are assigned to a different function. Un-assign a switch from another function to free it up for selection.

The DX5 Pro does not allow switch assignments to be overloaded, there is only one switch to one function. Once a switch is configured for a function, the switch assignment for that function must be disabled for the switch to be used for something else.

Drive Mode as a Switch Selection

Drive modes enable drivers to configure multiple features to a single switch. As many as five drive modes may be configured. Once the drive modes have been assigned, drive modes may be selected as a switch selection for various functions. This enables users to select multiple functions from a single switch. Each drive mode can have a full set of features for certain conditions.

Tip: Drive modes must be assigned to a switch in the drive mode menu for drive modes to be available for assignment for other functions.

FUNCTION LIST

Click the scroll wheel from the main screen to access the FUNCTION LIST. The FUNCTION LIST contains all the available menus on the DX5 Pro. The functions include:

- Model Select
- Model Name
- Servo Setup
- Rates
- Exponential
- Timer
- Bind/ Frame Rate
- Mixing
- AVC
- ABS
- Idle Up
- Traction

Pre-Loaded Model Setups

The DX5 Pro is pre-loaded with several Losi vehicles which take advantage of the drive mode capabilities in the radio.

- Trim Setup
- Channel Assign
- Telemetry
- Drive Mode Name
- System Settings
- System Setup

Model Select

Model Select enables you to access any of the 250 internal model memory locations in the Model Select list.

1. Scroll to the desired model memory in the Model Select list.
2. When the desired model memory is highlighted, click the scroll wheel once to select the model. The transmitter returns to the Main Screen.
3. Add a new model by rolling to the bottom of the list. You will then be prompted with the Create New Model screen, with the option to create a new model or cancel. If you select Cancel, the system will return to the Model Select function. If you select Create, the new model will be created and now be available in the model select list.



CAUTION: NEVER change the model in Model Select while operating a model. Changing the model memory interrupts the transmitter signal to the receiver and may cause loss of vehicle control, damage or personal injury.

On pre-loaded model files the D button selects from the 4 Drive Modes; Trainer, Slick, Stability, and Full Rip. All settings on the Pre-Loaded model files are free to be adjusted (refer to AVC setup information on page 14).

For more information on pre-loaded model setups, visit the DX5 Pro product page at SpektrumRC.com

Model Select

```
< BACK >
SuperBajaRay 6S
DBXL-E 8S
3XL-E 6S
Tenacity SC 2S
Tenacity MT 3S
Tenacity SC 3S
Tenacity T 3S
t: New Model
< Add New Model >
```

Model Name

Model Name enables you to assign a custom name to the current model memory. Model names can include up to 15 characters, including spaces.

To add letters to a Model Name:

1. Scroll to the desired letter position and click the scroll wheel once. A flashing box appears.
2. Scroll Up or Down until the desired character appears. Click the scroll wheel once to save the character.
3. Scroll to the next desired letter position. Repeat Steps 1 and 2 until the Model Name is complete.
4. Select Back Button to return to the MENU.

To erase a character(s):

1. Press the Clear button while the character is selected.
2. Press the Clear button a second time to erase all characters to the right of the cursor.

Model Name BACK

```
Name:
1 : VRoom
```

Servo Setup

The Servo Setup menu contains the following functions:

Travel

Travel sets the overall travel or endpoints of the servo arm movement. Travel values range from 0–150% (Default is 100%).

To adjust Travel values:

1. Scroll to the channel you wish to adjust and click the scroll wheel.
2. Scroll Up or Down to adjust the travel value. Click the scroll wheel to save the selection.

LIST

```
Travel
STR 100L 100R
THR 100L 100H
AX1 100% 100%
AX2 100% 100%
AX3 100% 100%
```

```
1 [ ] STR
2 [ ] THR
0 [ ] AX1
0 [ ] AX2
0 [ ] AX3
```

FUNCTION LIST

Sub-Trim

Subtrim offsets the entire range of servo travel including the center and endpoint positions.

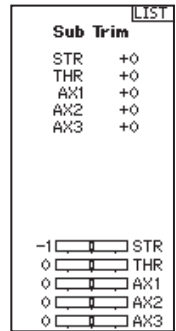

Reverse

Use the Reverse menu to reverse the channel direction. For example, if the Steering servo moves Left, reversing the channel will move the Steering servo Right.

To reverse a channel direction:

1. Scroll to Travel and click the scroll wheel. Scroll up or down until Reverse appears, then click the scroll wheel again to save the selection.
2. Scroll to the channel you wish to reverse and click the scroll wheel.

If you reverse the Throttle channel, a confirmation screen appears. Select YES to reverse the channel. A second screen appears, reminding you to bind your transmitter and receiver.



CAUTION: Always rebind the transmitter and receiver after reversing the Throttle channel. Failure to do so will result in the throttle moving to full throttle if failsafe activates.

Always perform a control test after making adjustments to confirm the vehicle responds properly.



CAUTION: After adjusting servos, always rebind the transmitter and receiver to set the failsafe position.

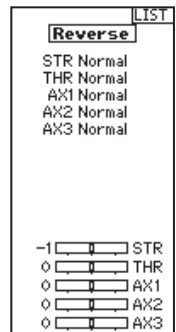

Speed

The Speed menu enables you to slow the response time on any individual channel.

The Speed is adjustable from 100% to 1%.

To adjust the Speed:

1. Scroll to the channel you wish to adjust and click the scroll wheel.
2. Scroll Up or Down to adjust the speed and click the scroll wheel to save the selection.
3. Select a switch to activate/deactivate the function. If Switch ON is selected, the value will always be on for that function.

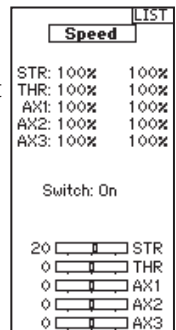

Rates

Rates allow the driver to reduce the travel (0-100%) of the Steering, Throttle, or Braking with a trimmer button. The Override option allows drivers to select a different rate value (0-125%) while holding down the assigned trimmer button. This is especially helpful for oval racers that program minimal steering throw to desensitize steering during racing, but requires maximum steering angle to drive out of a crash or get turned around on the track.

To adjust Rate values:

1. Scroll to Steering and click the scroll wheel to select between Steering, Throttle or Brake.
2. Scroll Up or Down to adjust the Rate value. Click the scroll wheel to save the selection.
3. Set the Switch setting to On to enable Rates, select Inh to disable Rates.
4. Select an Override rate and switch.
5. Select the OTF (On-The-Fly) trimmer that will be used to adjust Rates On-The-Fly.

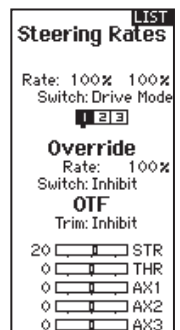

FUNCTION LIST

Exponential

The Exponential (Expo) function affects the response rate of the steering, throttle and/or brake. A positive Steering Expo value, for example, decreases steering sensitivity around neutral to make it easier to drive at high speeds in a straight line while still allowing for maximum turning radius. While sensitivity with positive Expo is decreased around neutral, it increases the sensitivity near the end of travel.

To adjust Expo values:

1. Select Throttle or Steering.
2. Scroll Up or Down to adjust the Rate value.
3. Click the scroll wheel to save the selection.
4. Select an OTF switch to activate Exponential.

IMPORTANT: Both positive and negative Expo values are available. A positive Expo value results in the center being less sensitive (desirable most of the time), while a negative value increases the sensitivity around center (normally not used).

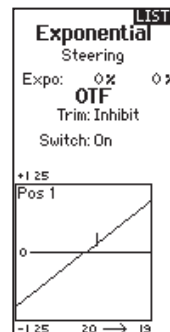

Timer

The DX5 Pro Timer function allows you to program a countdown timer and stop watch (count up timer) to display on the main screen. An alarm sounds when the programmed time is reached. You can program the timer to start using the assigned switch position or automatically when throttle moves above a pre programmed position.

Two internal timers are available that show run time for a specific model displayed on the Main Screen, and a total system timer.

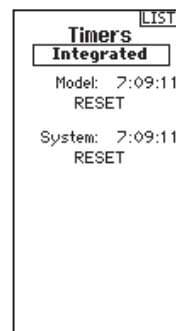
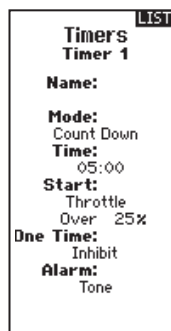

Frame Rate:

For compatibility with all types of servos, four frame rates are available:

- **5.5ms:** Gives the fastest response rate. Digital Servos and a compatible receiver are required.

IMPORTANT: When 5.5ms frame rate is selected, only two channels (steering and throttle) are operational.

- **11ms:** Offers good response rates and is compatible with most digital and analog servos (this is the default position). Works with DSMR surface receivers.

- **16.5ms:** Needed for older analog servos. Works with DSM2® surface receivers.
- **22ms:** Needed for older analog servos. Works with DSMR® receivers.

IMPORTANT: You should always use the fastest response rate the servos can handle. This gives the lowest latency and fastest response. If the frame rate is incompatible with the servo, the servo will move erratically or, in some cases, not at all. If this occurs, change the frame rate to the next highest value.

IMPORTANT: Always rebind after changing the Frame Rate.

Failsafe

The throttle failsafe position is set during binding. In the unlikely event that the radio link is lost during use, the receiver will drive the throttle servo to its pre-Programmed failsafe position (normally full brakes) and all other channels will have no servo output. If the receiver is turned on prior to turning on the transmitter, the receiver will enter the failsafe mode, driving the

throttle servo to its preset failsafe position. When the transmitter is turned on, normal control is resumed.

IMPORTANT: Failsafe activates only in the event that signal is lost from the transmitter. Failsafe will NOT activate in the event that receiver battery power decreases below the recommended minimums or power to the receiver is lost.

FUNCTION LIST

Binding

Binding is the Process of teaching the receiver the specific transmitter's code called GUID (Globally Unique Identifier) and storing failsafe values. When a receiver is bound to a transmitter/model memory, the receiver will only respond to that specific transmitter/model memory.

Bind the Transmitter to the Receiver

1. Place the receiver into Bind mode, the LED on the receiver will begin to flash.
2. Power on the transmitter.
3. Select the Model Memory you wish to bind to.
4. Select Bind from the List menu.
5. Move the throttle channel to the desired failsafe position.

IMPORTANT: The throttle channel must stay in the failsafe position until binding is complete.

6. Scroll to Bind and click the scroll wheel. The orange LED flashes on top of the transmitter.
7. When the bind process is complete, the transmitter and receiver LEDs stop flashing and turn solid orange.
8. Remove the bind plug from the receiver and keep it in a convenient place.

NOTICE: Always remove the bind plug from the receiver when the bind Process is complete. Failure to do so will cause the receiver to enter bind mode the next time you power on the receiver.

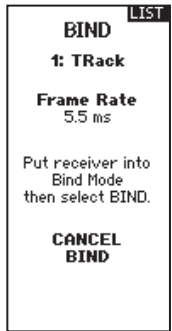

Mixing

Mixes can connect two servo outputs to one control input. The DX5 Pro features preset steering mixes and one programmable mix (Mix 0). The AUX channels can only be assigned to one mix at a time. If AUX 1, 2, or 3 is assigned to another mix, it will not be available as a slave channel option. AUX channels 1 and 2 are not available for use in mixes when the AVC menu in the transmitter is active.

- AUX1, AUX2 and AUX3 are available to serve as the slave channel.
- The AUX channels can only be assigned to one mix at a time. If AUX1, AUX2 or AUX3 is assigned to another mix, it will not be available as a slave channel option.

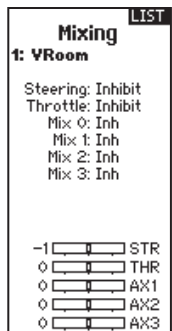

Steering Mix

The pre-configured Steering Mix options are for vehicles using two steering servos. For vehicles with servos independently controlling front and rear wheels, four-wheel steering (4WS) offers four different mixing options on one switch. The dual steering servo (Dual ST) mix is for vehicles with two servos working together on the front wheels.

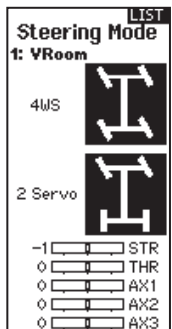

FUNCTION LIST

4WS (4-Wheel Steering)

4WS options in the DX5 Pro offer four different steering configurations using one switch; Crab, 4WS, front only, and rear only steering.

1. Select 4WS and click the scroll wheel.
2. To activate, select Inhibit and scroll to select the second steering channel. Select STR > AUX and scroll to choose a channel to use for the second steering (slave) channel.
3. Assign a switch or set the switch assignment to ON.
4. When a switch is assigned to select the 4WS mode, the four steering options each need to be assigned to a switch position and assigned rates to be enabled.
 - Select Pos: and use the scroll wheel to select the switch position (0-3). the current switch selection is indicated with a box around the 4WS mode.

- For Crab and 4WS steering, a set of travel settings and a trim option for the second servo appear when the Pos: setting is assigned to a switch position. Front only and Rear only steering options do not have travel or trim options.
- Use the scroll wheel to select the Trim option. Select Act to carry over trim settings to the mixed steering servo, leave Inh if the trim should only adjust the primary steering channel.

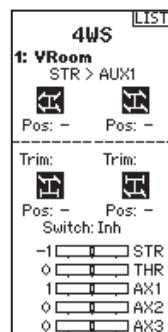

2 Servo (Dual Steering)

1. Select STEERING and click the scroll wheel.
2. Select 2 SERVO and click the scroll wheel.
3. To activate, select Inhibit and scroll to select STR > AUX.

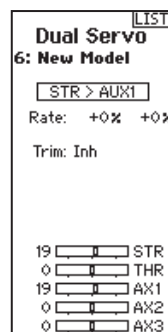

Dual Throttle

Use the DUAL THROTTLE Mix on vehicles that require two throttle channels.

1. Select THROTTLE and click the scroll wheel.
2. Select Dual Throttle and click the scroll wheel.
3. To activate, select Inhibit and scroll to select THR > AUX1.

To synchronize the servos use the Subtrim, Travel and Reverse menus in Servo Setup.

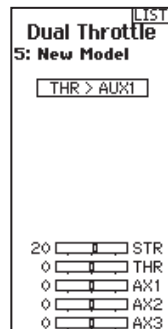

Dual Brake

Use the Brake Mix on large scale vehicles that require separate front and rear brake servos. The mix value creates brake bias between the front and rear brakes. Assigning the Brake Mix to a switch enables the driver to adjust the mix value from any screen.

1. Select THROTTLE and click the scroll wheel.
2. Select Dual Brake and click the scroll wheel.
3. To activate, select Inhibit and scroll to select BRK > AUX.

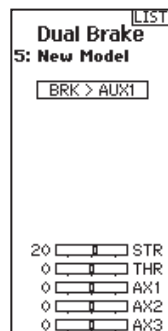

FUNCTION LIST

Mixing (continued)

Motor on axle (Moa)

The MOA Throttle Mix is used to adjust the throttle bias on rock crawlers using a “motor on axle” configuration.

1. Select THROTTLE and click the scroll wheel.
2. Select MOA and click the scroll wheel.
3. To activate, select Inhibit and scroll to select THR > AUX.
4. Assign a switch to the mix.

Only the rate value for the front motor can be edited. As you configure the front rate, the rear rate is updated appropriately to show the distribution.

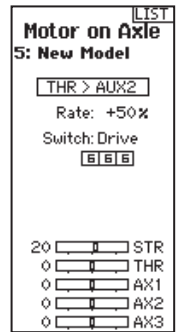

Programmable Mix

A freely assignable mix allows drivers to set up a second (Slave) channel to follow a primary (Master) channel.

1. Select Mix 0 and click the scroll wheel. In the mixing menu, select Mix 0 to rename the mix.
2. To activate, select a Master and Slave channel and assign the Rate.
 - Select Inhibit under Master and scroll to select the Master (input) channel.
 - Select Inhibit under Slave and scroll to select the Slave (output) channel.
 - Rate settings define travel limits and direction. Move the input channel (steering wheel, throttle, or whatever function is assigned to the master channel) to adjust the rate for each side of the slave channel travel. Setting this value positive or negative determines the slave servo direction.

3. Select Switch; Inh will disable the mix, ON will activate the mix, or a switch can be assigned to turn the mix on and off.
4. Set Trim to Act or Inh (Default). When Trim is Active, adjustments to the Master trim carries over to the Slave channel.

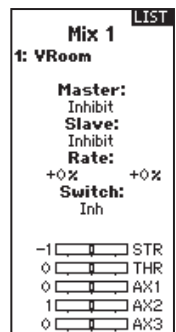

AVC Programming Menu

The DX5 Pro includes a menu for optional AVC receivers (not included). This menu manages AUX 1 and AUX 2 operation and tailors it for AVC technology use. When AVC is active, the radio system will use the AUX 1 and AUX 2 channels for gain control. AUX 1 will follow steering gain, and AUX 2 will follow throttle gain. AUX 1 and AUX 2 are not available for use in mixes when AVC is active. For an independent channel, use AUX 3.

When not using an AVC receiver, leave the AVC menu in the DX5 Pro inhibited (INH)

To activate the AVC menu:

1. Select AVC in the main menu
2. Select Switch and use the scroll wheel to select On to enable the AVC menu.
3. Change the gain and priority values to suit the vehicle.
4. To fine tune each value during use without having to access the programming menu, assign a trimmer to the On-The-Fly (OTF) feature for each AVC value. Click on the arrow to the right of the switch selection to set the trimmer to increase or decrease the gain from the set value.

TIP: Trimmers can only be assigned to one OTF function; Steering and throttle gain values cannot be adjusted from one trimmer button.

Important: If an AVC receiver is bound with a single bind plug, and no bind plug in the disable port, it will be in AVC mode.

If the AVC feature in the receiver is active and the AVC menu in the transmitter is inhibited, AVC functions will default to the AUX 1 and AUX 2 operation, and in this scenario, AVC will not work correctly.

For AVC equipped receivers (not included with the DX5 Pro), selecting INH in the AVC menu alone will not disable AVC .

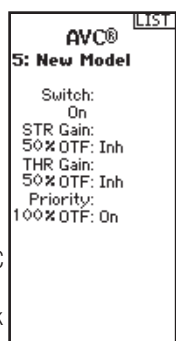

FUNCTION LIST

AVC Tuning (AVC Receiver not included)

A value from 0 to 100 is used for three settings that affect tuning; steering gain, throttle gain, and priority. These values configure the receiver to your vehicle so you can tune it for optimal performance based on your driving style. It is normal for gain and priority tuning results to vary.

What Is Gain?

A gain value of 0 will result in zero electronic corrections, and a gain of 100 will result in large corrections in an effort to hold a straight line.

- Steering gain tells the receiver how strongly to assist steering when the vehicle begins to spin out of control.
- Throttle gain tells the receiver how much it can assist on the throttle when the vehicle begins to spin out of control.

Default gain values are 50. We recommend adjusting gain values 5 points at a time. Fine tune the settings with smaller increments as desired performance is achieved. Avoid large increases to steering gain values between tests.

What is priority?

Priority tells the receiver how much you want to be able to override the electronic stability with your steering commands. A low priority means AVC will make steering corrections when you turn wheel all the way. A high priority will reduce AVC the more you turn the wheel.

The default priority value is 100. This means when you turn the steering wheel to the limit, the gain is reduced to zero. This value will work well for a majority of drivers

What is heading Hold?

Heading hold maintains the selected vehicle direction. It is normal to see the wheels steer in the same direction it was last pointed. If a vehicle with AVC technology is lifted off the ground and turned from side to side, the wheels will steer in an effort to get back to the original heading. When driving, heading hold only works when the steering wheel is left straight. The moment you begin to turn the wheel, heading hold turns off. When the wheel is re-centered, heading hold is turned back on.

AVC Tuning Procedure

1. With the transmitter and receiver already bound and properly calibrated, turn on the transmitter and vehicle.
2. Apply throttle, do not turn the steering wheel, and observe how well the vehicle can maintain a straight line at high speed.
 - If the vehicle does not make enough steering corrections to maintain a straight line, increase the steering gain. If the vehicle fishtails due to wheel-spin, increase the throttle gain.
 - If the vehicle wobbles (oscillates), reduce the steering gain.
 - The maximum gain values that prevent oscillations at high speed should not be exceeded.
3. Drive the vehicle through accelerated turns and observe how it responds.
 - If the vehicle slows down going into a turn, reduce the throttle gain.
 - To allow the vehicle to slide more with intentional wheel-spin, reduce the throttle gain.
 - To improve traction in slick conditions, increase throttle gain.
 - If the vehicle won't turn-in, increase the priority.
 - If the vehicle spins out, there are two tuning options to consider;
 1. Increasing throttle gain will help correct for undesirable wheel-spin when the vehicle over-rotates.
 2. Reducing priority will give the receiver more authority to help correct oversteer.

General Tuning Tips

For beginner drivers, looser conditions, and vehicles with excessive power, more gain will be helpful.

For terrain with more grip and increased speeds, tuning will result in lower steering gain values.

Important: If the steering or throttle trim is adjusted on the transmitter, turn the receiver off and on again in order to save the new trim settings. Otherwise, AVC will not function properly.

Changing Battery Voltage

If the voltage is increased, the maximum steering gain setting will have to be reduced.

At the same time, when increasing voltage, increased throttle gain will help manage the extra power.

For example: If a truck set up for 2S is upgraded to 3S, the truck may oscillate at high speeds on 3S, requiring steering gain to be reduced. Throttle gain will have a bigger effect on 3S, so increasing throttle gain may be beneficial.

FUNCTION LIST

Automatic Braking System (ABS)

ABS helps prevent brake lock-ups and improves braking performance by pulsing the brakes. ABS helps prevent brake lock-ups and improves braking performance by pulsing the brakes.

Options:

- **Point:** The throttle position that the pulse braking takes place (0 to 100, default is 50).
- **Stroke:** The distance the throttle travels during the pulse braking (0 to 100, default is 50).
- **Lag:** The time delay before the pulsing takes place (0.0 to 2.0 in .01 increments, default is 0.0).
- **Speed:** The pulsing speed or frequency of the pulse braking (-1 to -30, default is -10).

To activate ABS:

1. Assign a switch to toggle ABS ON/OFF or select ON.
2. Select functions to edit.
3. The bar at the bottom of the screen displays the parameters and shows how ABS will function.

Deactivating ABS

- Assign switch to INH.

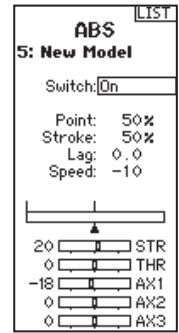

Idle Up

Idle up (also called high idle) is used to advance the throttle position on a gas car during startup to prevent the engine from dying before the engine is warmed up.

Options:

- **Position:** Adjusts the throttle position when idle up is engaged (0 to 100, default is 0)
- **Warning:** Activates an alarm when the Idle Up is active

To activate Idle Up:

1. Assign a switch to toggle Idle Up ON/OFF.
2. Select functions to edit.
3. The bar at the bottom of the screen displays the parameters and shows how Idle Up will function.

Deactivating Idle Up

- Assign switch to INH.

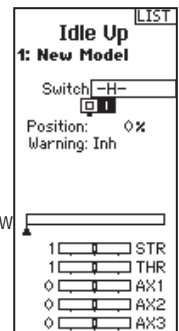

Traction

Traction Control helps reduce wheel slippage and improve acceleration by gradually increasing the throttle.

Options:

- **Point:** The throttle position that traction control disengages (5 to 100, default is 50).
- **Speed:** The time after pulling the trigger traction control engages (1 to 100, default is 10).

To activate Traction:

- Assign a switch to toggle Traction ON/OFF.
- Select functions to edit.
- Select the On The Fly (OTF) switch to edit settings with out going into the Traction menu.
- The bar at the bottom of the screen displays the parameters and shows how Traction will function.

Deactivating Traction:

- Assign switch to INH.

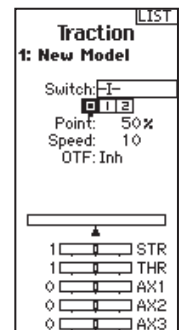

Trim setup

Trim Setup affects the amount the servo travels with each click of the trim, but has no effect on the total trim travel. The trim steps range from 1 to 20 (Default is 9).

To adjust the trim steps:

1. Select channels to edit.
2. Scroll Up or Down to adjust the step value.
3. Click the scroll wheel to save the selection.

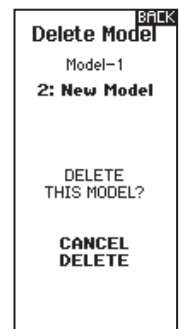

FUNCTION LIST

Trim Assign

Trim Assign allows for the assigning of a switch to the Steering or Throttle trims.

1. From within Trim Setup, select NEXT.
2. Select channels to assign a switch to.
3. Scroll Up/Down or toggle a switch/button to assign.
4. Click the scroll wheel to save the selection.

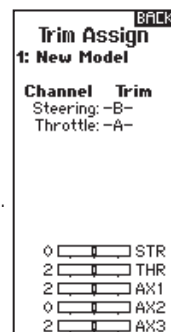

Aux Assign

Channel Assign allows for the assigning of a switch or trimmer as input to an AUX channel.

Channel assign:

1. Select a channel to edit. Click the scroll wheel to save the selection.
2. Scroll Up/Down or toggle a switch/button to assign.
3. Click the scroll wheel to save the selection.

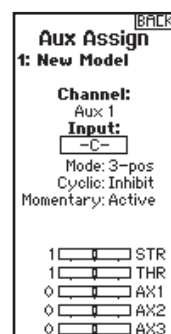

Telemetry

The telemetry screen allows for easy access to all telemetry sensors and settings.

To add telemetry sensors:

1. Select an empty slot.
2. Push the scroll wheel once and scroll to find the desired telemetry sensor.
3. Click the scroll wheel to save the selection.

To edit telemetry sensors:

4. Select the sensor from the list.
5. Push the scroll wheel once to open that sensors settings.
6. Adjust sensor parameters.
7. Click the scroll wheel to save the selection.

Settings: Chose how telemetry is displayed on the transmitter.

File Settings:

- Displays File name of saved telemetry files.
- Inhibit, activate telemetry file saving.

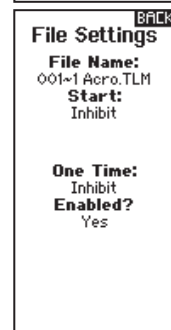
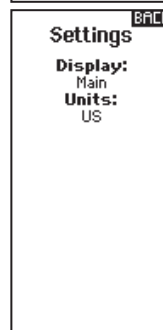
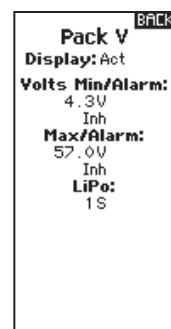
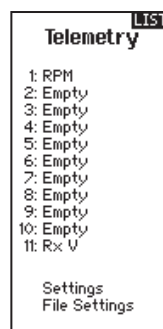

FUNCTION LIST

Drive Mode

Every model can have up to 5 drive modes programmed to a switch or button for On-The-Fly adjustments.

Once a drive mode is selected, changes may be made to various functions from a single switch selection. Where as normally functions are limited to one switch at any time, with a drive mode enabled, multiple functions tied to a single switch let a driver make quick changes.

For initial tuning individual switch selections are ideal, but once settings are found, the Drive Mode function lets drivers group settings for specific conditions.

Select the On The Fly (OTF) switch to switch between drive modes.

1. Scroll down to Modes; Drive Mode 1 and click the scroll wheel to rename the mode if desired.
2. Select the (+) to add a new Drive Mode. Up to five modes may be added.

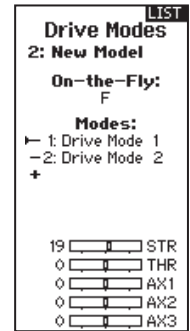

Lap Timer

Lap timing with the DX5 Pro can be triggered with the Spektrum lap timing telemetry system, or may be triggered manually with a switch.

1. Select the Lap Timer menu in the Function List.
2. Configure the timer mode and set the maximum number of laps.
3. In the Trigger selection, choose **Telemetry** if the Spektrum Lap timing system sensor is connected to the X-Bus connection on the receiver.
4. To log lap times onto an SD card, determine the file name and change the option for **Enabled?** to **Yes**.
5. Select **NEXT** to choose event reporting options. This is where to configure how and when the transmitter indicates a lap has been counted (vibration or tone).

Lap Timer Telemetry Screen

6. Access the Lap timing telemetry menu by scrolling right from the home screen.
7. Select **Review** to view times from previous heats.

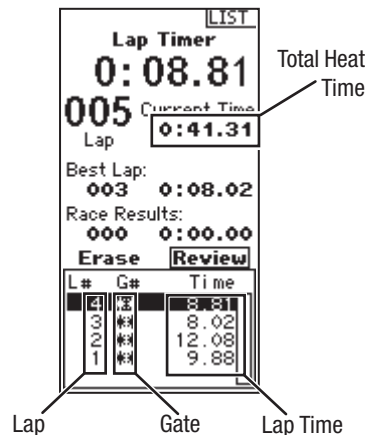
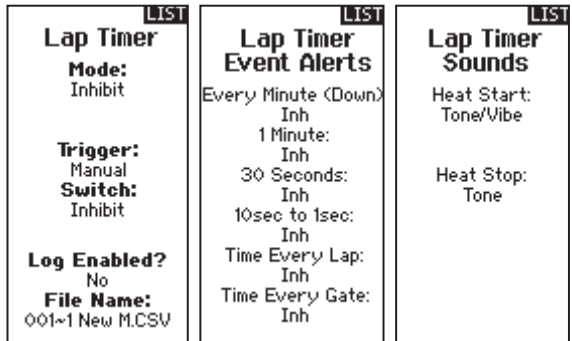

SYSTEM SETTINGS

System settings allows adjustments to the following transmitter settings:

- **Display**
- **Trims**
- **Sounds**
- **About**
- **Calibrate**

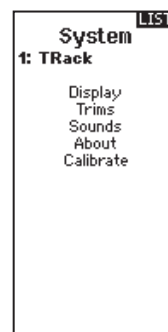

Display

User Name

The User Name field displays your name above the model name on the main screen.

1. Scroll to the desired letter position and click the scroll wheel once. A flashing box appears.
2. Scroll Up or Down until the desired character appears. Click the scroll wheel once to save the character.
3. Scroll to the next desired letter position. Repeat Steps 1 and 2 until the Model Name is complete.

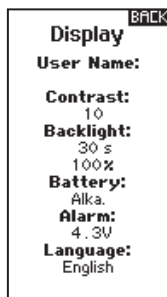

CAUTION: Never select NiMH when a LiPo/Li-Ion battery is installed in the transmitter. Doing so may over-discharge the LiPo battery and damage the battery, transmitter or both.



CAUTION: Never adjust the low voltage limit for the LiPo/Li-Ion battery pack below 6.4V. Doing so could over-discharge the battery pack and damage both battery pack and transmitter.

Language:

Change the transmitters language.

Inactive Alarm:

An alarm activates if the transmitter sees a period of inactivity for a certain amount of time. The alarm is helpful in reminding you to power off the transmitter and avoiding a situation where the transmitter battery completely discharges.

- Inh (No alarm sounds)
- 5 min
- 10 min (Default)
- 30 min
- 60 min

Contrast

To adjust the screen contrast:

1. Scroll to Contrast and click the scroll wheel.
2. Scroll Up or Down to adjust the contrast value. Lower numbers lighten the contrast, higher numbers darken it.
3. Click the scroll wheel once to save the selection.

Backlight:

The Backlight field adjusts the backlight appearance time and brightness. You have the option to turn the backlight On or Off or set how long the display stays lit (3, 10, 20, 30, 45 or 60 seconds).

Battery:

Select from Alka (default), Lilon, LiPo or NiMH battery types. Note that when the battery type is changed the Battery alarm automatically changes for the correct type of battery chemistry.

Alarm:

Set the low voltage for each battery type. The recommended low voltage threshold is set by default for each battery type.

SYSTEM SETTINGS

Trims

Assign Trims to any trimmer or switch on the transmitter.

1. Select the Trim position from the list.
2. Push the scroll wheel once to select the position.
3. Scroll to select the Trim desired in that position.
4. Click the scroll wheel to save the selection.

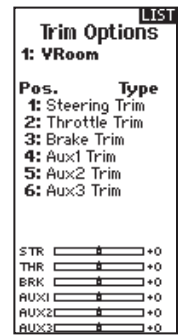

Sound settings

Turn system sounds ON/OFF.

1. Select the sound from the list.
2. Push the scroll wheel once to Activate/Inhibit.
3. Click the scroll wheel to save the selection.



About

Displays the transmitter's Serial Number.

Calibrate

Use this menu to calibrate controls. After making any physical transmitter changes it is recommended to calibrate the transmitter.

1. Move the Steering Wheel, Throttle/Brake and the knob from stop to stop.
2. Center the knob.
3. Save when finished or cancel to go back.

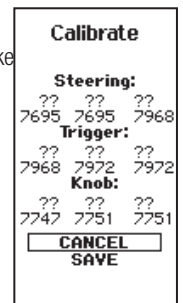

SYSTEM SETUP

Press and hold the scroll wheel while powering on the transmitter to show the System Setup list. No radio transmission occurs when a System Setup screen is displayed, preventing accidental damage to linkages and servos during changes to programming.

The System Setup menu can also be accessed from the Function list without turning the transmitter off. A Caution screen will appear that warns that RF will be disabled (the transmitter will no longer transmit). Press **YES** if you are sure and want to access

the System List. If you are not sure, press **NO** to exit to the main screen and continue operation.

If you do not press **YES** or **NO**, the system will exit to the main screen and continue operation within approximately 10 seconds.

Caution: Do not press **YES** unless the model is turned off and secured.

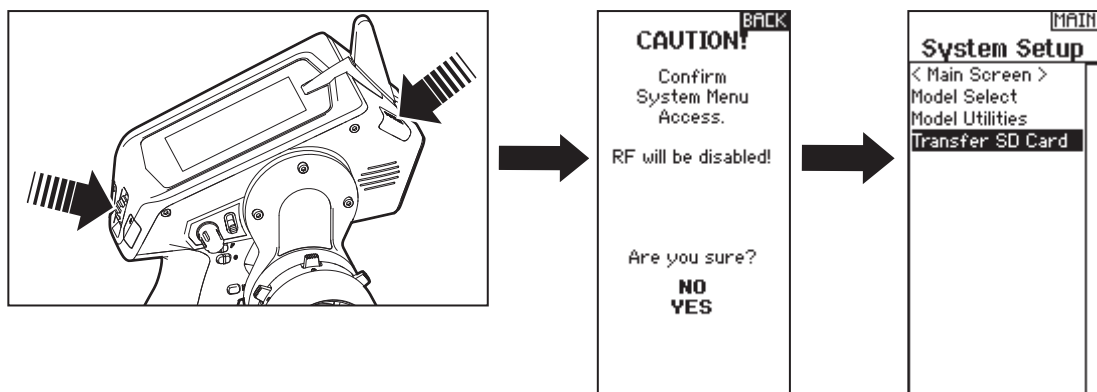

Model Select

Model Select enables you to access any of the 250 internal model memory locations in the Model Select list.

1. Scroll to the desired model memory in the Model Select list.
2. When the desired model memory is highlighted, click the scroll wheel once to select the model. The transmitter returns to the Main Screen.
3. Add a new model by rolling to the bottom of the list. You will then be prompted with the Create New Model screen.

For more information on pre-loaded model setups, visit the DX5 Pro product page at SpektrumRC.com

Caution: NEVER change the model in Model Select while operating a model. Changing the model memory interrupts the transmitter signal to the receiver and may cause loss of vehicle control, damage or personal injury.

Model Select

```

< BACK >
SuperBajaRey 6S
DBXL-E 8S
3XL-E 6S
Tenacity SC 2S
Tenacity MT 3S
Tenacity SC 3S
Tenacity T 3S
! New Model
< Add New Model >
  
```

Model Utilities

In the Model Utilities function you can create a new model, delete a model, copy a model, reset a model to default settings and sort the model list.

Model Utilities

```

Create New Model
Delete Model
Copy Model
Reset Model
Sort Model List
  
```

SYSTEM SETUP

Create new model

1. Select the CREATE NEW MODEL and click the scroll wheel.
2. Select CREATE to create a new model or CANCEL to go back.
3. The new model is available in the model select list.



CAUTION: NEVER change the model in Model Select while operating a model. Changing the model memory interrupts the transmitter signal to the receiver and may cause loss of vehicle control, damage or personal injury.

Create New Model

Do you want to create a new model?

CANCEL
CREATE

Delete Model

Use this selection to permanently delete a model from the model select list. If you do not wish to delete a model, select Cancel to exit the page.

1. To delete a model, highlight the model listed. Press to select then roll to the model name. Click the scroll wheel to select.
2. Select DELETE to delete the model.

Delete Model BACK

Model-1

2: New Model

DELETE
THIS MODEL?

CANCEL
DELETE

Model Copy

The Model Copy menu enables you to duplicate model programming from one Model List location to another.

Use Model Copy to:

- Save a default model copy before experimenting with programming values
- Expedite programming for a model using a similar programming setup

IMPORTANT: Copying a model program from one model memory to another will erase any programming in the "To" model memory.

You cannot use the Model Copy screen to copy model programming to an SD Card. To copy model programming to the SD Card, please see "Transfer SD Card".

To copy model programming:

1. Select where to save the copied memory by selecting "TO" and scroll to ADD NEW MODEL. Click the scroll wheel once to save the selection. To save over a current model select that model from the list.
2. Select the model to be copied by selecting "From" and scroll to the model to be Copied.
3. Scroll down to COPY at the bottom of the screen and click the scroll wheel once.
4. Confirm the copy by selecting COPY or CANCEL to go back.

Model Copy LIST

From 2

2: New Model

To 250

< Add New Model >

CANCEL
COPY

Reset Model

Use the Model Reset menu to delete all model programming in the active model memory. Reset returns all model settings to the default settings and erases all programming in the selected model.

IMPORTANT: After a model reset, it is necessary to re-bind.

Confirm Reset BACK

Model-2

2: New Model

DATA WILL
BE RESET

CANCEL
RESET

SYSTEM SETUP

Sort Model List

With this function you can sort the model order in the model select function. This is helpful to group similar models together to make them easy to find. To move a model, highlight the model that you wish to move with the scroll wheel, then click the scroll

wheel to select it. Scroll the scroll wheel to move the selected model to the position desired. Click the scroll wheel when you have the model in the position desired.

Transfer sd card

The SD Card enables drivers to:

- Import model(s) from another DX5 Pro transmitter
- Export model(s) to another DX5 Pro transmitter
- Update firmware in the transmitter (covered under the SD card section of this manual)

Import model

To import an individual model file from the SD Card:

1. Save the model file to the SD Card and insert into the transmitter.
2. In the Transfer SD Card menu, scroll to Options and click the scroll wheel once.
3. Scroll to Import Model and press the scroll button again to save the selection. The Select File screen appears.
4. Select the model file you wish to import. The Import Model screen appears.
5. Select Import to save the model to the transmitter. The new model will be appended to the end of the model list.

Import All Models

To import all models from the SD Card:

1. Select Import All Models.
 2. Confirm by selecting IMPORT.
- IMPORTANT:** After importing a model, you must rebind the transmitter and receiver.

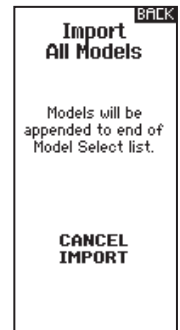

Export model

You can use the Export Model option to export a single model file to the SD Card.

1. Make sure the active model file is the one you wish to Export.
2. In the Transfer SD Card menu, scroll to Options and click the scroll wheel once.
3. Scroll to Export Model and click the scroll wheel again to save the selection. The Export to SD screen appears. The first two characters of the file name correspond to the Model List number (01, for example).
4. Select Export to save the file to the SD Card. When the export is complete, the transmitter returns to the SD Card Menu screen.

Export All Models

To export all models to the SD Card:

1. Select Export All Models in the Transfer SD Card Menu options. The Export All Models screen appears.
- IMPORTANT:** Export All Models will overwrite any model files that have the same name. Always save model files to a different SD card if you are not sure.
2. Select Export to overwrite files on the SD Card or Cancel to return to the SD Card Menu.

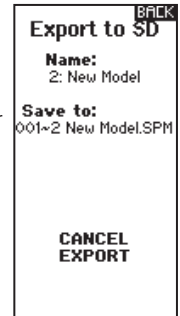

PHYSICAL TRANSMITTER ADJUSTMENTS

The DX5 Pro is designed to be extremely adjustable to suite a wide variety of driver needs. Available adjustments are:

- Adjustable trigger and steering tension
- Multiple trigger position
- Multiple wheel drop-down options
- 2 optional grip sizes (not included)
- 10° and 15° Steering Adapters (not included)
- Small and Large Steering Wheel (small wheel not included)

Throttle Distance Adjustment

Loosen the bolt with a 2.5mm hex wrench. Move the throttle trigger in or out and tighten.

Throttle Tension Adjustment

Turn the screw clockwise with the 1.5mm hex wrench to increase the trigger tension.

Steering Tension Adjustment

Turn the screw clockwise with the 1.5mm hex wrench to increase the steering tension.

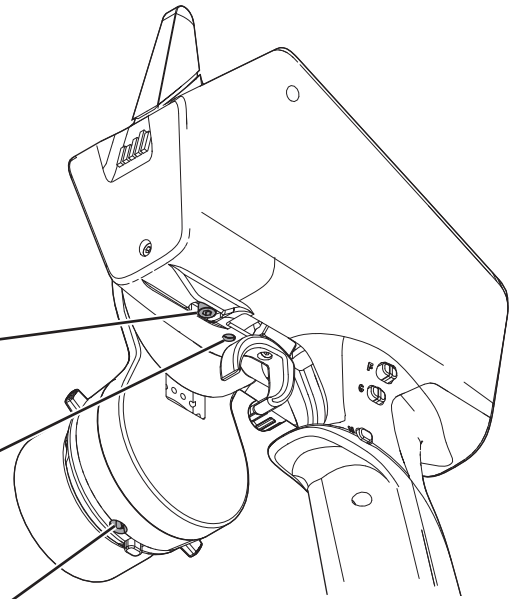

Changing grips

The DX5 Pro comes with the medium-size grip installed at the factory. To install optional grips:

- Lift the edge of the grip and pull the grip away from the handle.
- Align the tabs on the new grip with the slots in the handle.
- Press the grip against the handle.

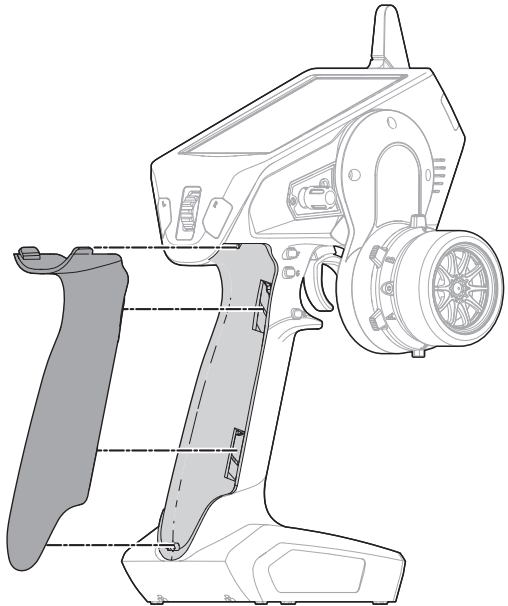

PHYSICAL TRANSMITTER ADJUSTMENTS

Dropdown steering wheel options

The DX5 Pro comes with the dropdown wheel installed. The dropdown can be rotated for a perfect feel or removed for a standard wheel layout. All the parts necessary to convert to the standard wheel are included.

Rotate:

- Turn off the DX5 Pro
- Using a 2mm hex wrench, remove 3 screws.
- Rotate the drop down to the desired angle.
- Align with the screw holes and re-install the 3 screws being careful not to pinch any wires.

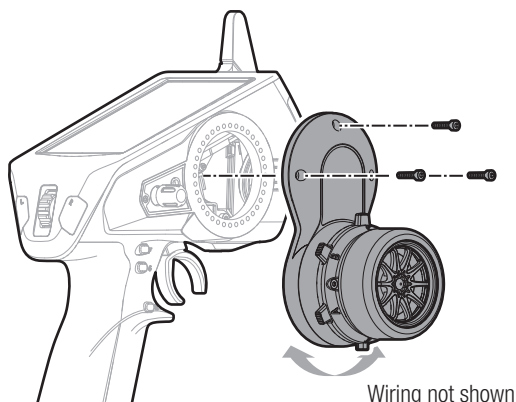

Standard wheel conversion:

- Using a 2mm hex wrench, remove the 3 screws from the drop down and remove the drop down from the transmitter. Carefully disconnect the 2 wiring harness from inside the transmitter.
- Using a 1.5mm hex wrench, remove the steering wheel.
- Using a 2mm hex wrench, remove 2 screws from the steering mechanism. Remove the steering mechanism from the drop down being careful to pull the wiring harness through the opening.
- Keep the drop down in a safe place for future use.
- Connect the 2 wiring harnesses to the board inside the DX5 Pro. Note that one connector has 6 pins and the other has 7.
- Re-install the steering mechanism directly onto the transmitter using the 2 screws.
- Re-install the steering wheel.

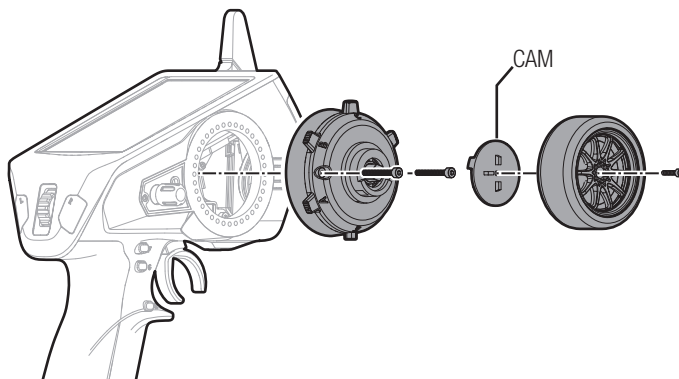

Steering Wheel Wedges

- Refer to the Drop down steering wheel options section above for directions on removing and installing the steering mechanism.
- The wedge goes between the steering mechanism and the drop down (or transmitter if the drop down is not being used) and can be rotated to almost any angle.
- Wedges are two parts so wiring does not have to be removed for changes.

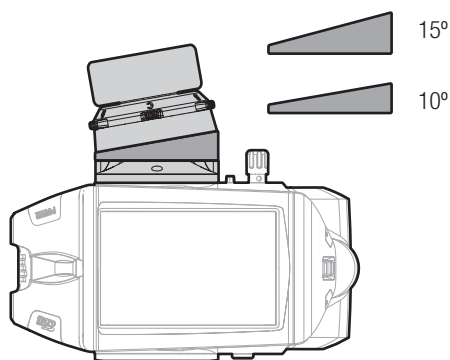

SR2100 RECEIVER

The Spektrum™ DX5 Pro bundle SPM5010 includes the SR2100 3-channel DSMR® receiver. This receiver is optimized for racing applications and is compatible with all Spektrum DSMR surface transmitters. The SR2100 receiver does not feature telemetry. Install the SR2100 receiver securely where it is protected and isolated from vibration. The SR2100 receiver has an integrated PCB antenna in the case, and the bind button needs to be accessible. Use double sided servo tape or hook and loop tape to install the receiver upright with the servo connectors facing up.

Specifications

Specifications	SR2100
Type	DSMR Micro Race
Dimensions (LxWxH)	17.6 x 25.5 x 25mm
Channels	3
Weight	5.5g
Band	2.4GHz
Frame rate	11ms-5.5ms
Voltage Range	3.5–9V

Typical Electric Vehicle Installation

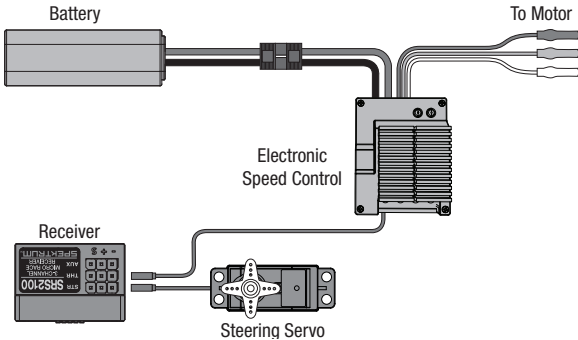

Typical Nitro Vehicle Installation

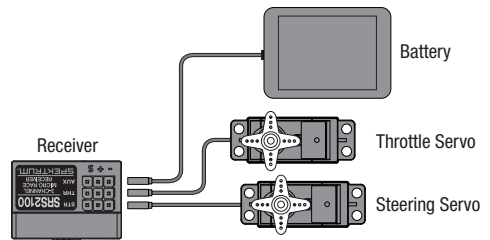

BINDING THE SR2100 RECEIVER TO THE DX5PRO

In order to operate, the receiver must be bound to the transmitter. Binding is the process of programming the receiver to recognize the GUID (Globally Unique Identifier) code of a single specific transmitter. When a receiver is bound to a transmitter/model memory, the receiver will only respond to that specific transmitter/model memory.

Binding

1. Push and hold the bind button on the receiver while powering up the receiver. The orange LED will flash continuously, indicating that the receiver is in bind mode.
2. With all channels in the desired preset failsafe position (normally neutral), put the DX5 Pro in bind mode. Continue holding the failsafe position until the binding process is complete.
3. The bind process is complete when the orange LED on the receiver is solid.

CAUTION: When the bind process is complete, the throttle and steering channels are active. Keep hands and loose objects away from all spinning parts on the vehicle.

You must rebind the transmitter and receiver if you:

- Change the servo reverse after binding.
- Want to use the receiver with a different model memory.
- Are using the receiver with a DSMR transmitter and you change the frame rate in the transmitter.

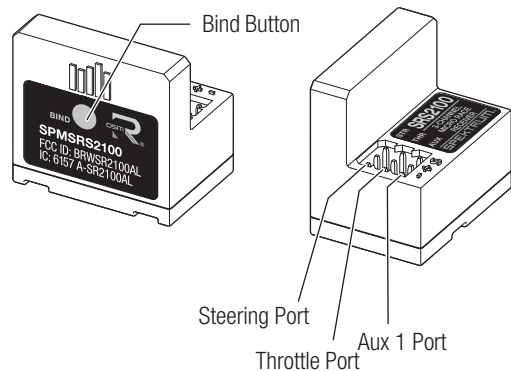

Aux Channel

The Aux servo channel is not operable when the SR2100 receiver is operating in 5.5ms mode. If 5.5ms frame rate is selected in the transmitter, only two channels, Steering and Throttle, are operational.

Add - Aux channel can be used to operate an additional channel, personal transponder or a fan. To use a transponder and fan at the same time a Y-Harness (SPM1516) would be required.

OPTIONAL LITHIUM BATTERY

Installing Optional Lithium Ion Battery Pack (not included)

IMPORTANT: Set the transmitter battery type to Li-Ion in the Display/Battery menu and ensure the battery voltage alert is set to the proper voltage. See the *System* section for more details.

1. Remove the battery cover from the bottom of the transmitter.
2. Remove the AA battery holder and disconnect from the transmitter power port.
3. Connect the battery pack to the transmitter power port.
4. Install the battery pack into the transmitter.
5. Install the battery cover.

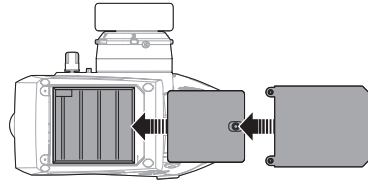

CAUTION: Risk of explosion if battery is replaced by an incorrect type. Dispose of used batteries according to state and local laws.

TROUBLESHOOTING GUIDE

PROBLEM	POSSIBLE CAUSE	SOLUTION
The system will not connect	Transmitter and receiver too near each other	Move transmitter 8 to 12 feet (2.4 to 3.6m) from receiver
	Transmitter and receiver too near large metal objects (vehicles, etc.)	Move away from large metal objects (vehicles, etc.)
	Selected model is not bound in transmitter	Make sure correct model memory is selected and that transmitter is bound to the model
	Transmitter accidentally put in bind mode so receiver is no longer bound	Rebind transmitter and receiver
	Bind plug left installed in bind port	Rebind transmitter to the vehicle and remove the bind plug before cycling power
	Vehicle battery/Transmitter battery charge is too low	Replace/recharge batteries
The receiver goes into failsafe mode a short distance away from the transmitter	The receiver needs to be properly mounted for antenna placement	Replace or contact Horizon product Support
Receiver quits responding during operation	Low battery voltage	Completely recharge battery
	Loose or damaged wires or connectors between battery and receiver	Do a check of the wires and connection between battery and receiver. Repair or replace wires and/or connectors
Receiver loses its bind	Transmitter accidentally put in bind mode, ending bind to receiver	Bind transmitter to receiver
Can't assign functions to the desired switches or buttons	Buttons and/or switches are already assigned to another function	Re-assign functions to other buttons or switches to free up the switch so it can be assigned to your designated function
	Function requires a switch or trimmer, but-tons have limited functionality	Select a switch or trimmer if your designated function will not work with a button.

OPTIONAL PARTS LIST

PART #	PARTS DESCRIPTION
SPM6719	Spektrum DX6R Transmitter Case
SPM9050	Grip Set, S, M, L: DX6R
SPM9052	Small Wheel w/Foam: DX6R
SPM9053	Wedges, 10/15 Deg: DX6R
SPM9055	Wheel Cam Set, 32/36 Deg: DX6R
SPM9058	Grip Attachment Tape: DX6R

Additional optional parts and details are available at SpektrumRC.com

1-YEAR LIMITED WARRANTY

What this Warranty Covers

Horizon Hobby, LLC, (Horizon) warrants to the original purchaser that the product purchased (the "Product") will be free from defects in materials and workmanship for a period of 1 year from the date of purchase.

What is Not Covered

This warranty is not transferable and does not cover (i) cosmetic damage, (ii) damage due to acts of God, accident, misuse, abuse, negligence, commercial use, or due to improper use, installation, operation or maintenance, (iii) modification of or to any part of the Product, (iv) attempted service by anyone other than a Horizon Hobby authorized service center, (v) Product not purchased from an authorized Horizon dealer, (vi) Product not compliant with applicable technical regulations or (vii) use that violates any applicable laws, rules, or regulations.

OTHER THAN THE EXPRESS WARRANTY ABOVE, HORIZON MAKES NO OTHER WARRANTY OR REPRESENTATION, AND HEREBY DISCLAIMS ANY AND ALL IMPLIED WARRANTIES, INCLUDING, WITHOUT LIMITATION, THE IMPLIED WARRANTIES OF NON-INFRINGEMENT, MERCHANTABILITY AND FITNESS FOR A PARTICULAR PURPOSE. THE PURCHASER ACKNOWLEDGES THAT THEY ALONE HAVE DETERMINED THAT THE PRODUCT WILL SUITABLY MEET THE REQUIREMENTS OF THE PURCHASER'S INTENDED USE.

Purchaser's Remedy

Horizon's sole obligation and purchaser's sole and exclusive remedy shall be that Horizon will, at its option, either (i) service, or (ii) replace, any Product determined by Horizon to be defective. Horizon reserves the right to inspect any and all Product(s) involved in a warranty claim. Service or replacement decisions are at the sole discretion of Horizon. Proof of purchase is required for all warranty claims. SERVICE OR REPLACEMENT AS PROVIDED UNDER THIS WARRANTY IS THE PURCHASER'S SOLE AND EXCLUSIVE REMEDY.

Limitation of Liability

HORIZON SHALL NOT BE LIABLE FOR SPECIAL, INDIRECT, INCIDENTAL OR CONSEQUENTIAL DAMAGES, LOSS OF PROFITS OR PRODUCTION OR COMMERCIAL LOSS IN ANY WAY, REGARDLESS OF WHETHER SUCH CLAIM IS BASED IN CONTRACT, WARRANTY, TORT, NEGLIGENCE, STRICT LIABILITY OR ANY OTHER THEORY OF LIABILITY, EVEN IF HORIZON HAS BEEN ADVISED OF THE POSSIBILITY OF SUCH DAMAGES. Further, in no event shall the liability of Horizon exceed the individual price of the Product on which liability is asserted. As Horizon has no control over use, setup, final assembly, modification or misuse, no liability shall be assumed nor accepted for any resulting damage or injury. By the act of use, setup or assembly, the user accepts all resulting liability. If you as the purchaser or user are not prepared to accept the liability associated with the use of the Product, purchaser is advised to return the Product immediately in new and unused condition to the place of purchase.

Law

These terms are governed by Illinois law (without regard to conflict of law principals). This warranty gives you specific legal rights, and you may also have other rights which vary from state to state. Horizon reserves the right to change or modify this warranty at any time without notice.

WARRANTY SERVICES

Questions, Assistance, and Services

Your local hobby store and/or place of purchase cannot provide warranty support or service. Once assembly, setup or use of the Product has been started, you must contact your local distributor or Horizon directly. This will enable Horizon to better answer your

questions and service you in the event that you may need any assistance. For questions or assistance, please visit our website at www.horizonhobby.com, submit a Product Support Inquiry, or call the toll free telephone number referenced in the Warranty and Service Contact Information section to speak with a Product Support representative.

Inspection or Services

If this Product needs to be inspected or serviced and is compliant in the country you live and use the Product in, please use the Horizon Online Service Request submission process found on our website or call Horizon to obtain a Return Merchandise Authorization (RMA) number. Pack the Product securely using a shipping carton. Please note that original boxes may be included, but are not designed to withstand the rigors of shipping without additional protection. Ship via a carrier that provides tracking and insurance for lost or damaged parcels, as Horizon is not responsible for merchandise until it arrives and is accepted at our facility. An Online Service Request is available at http://www.horizonhobby.com/content/_service-center_render-service-center. If you do not have internet access, please contact Horizon Product Support to obtain a RMA number along with instructions for submitting your product for service. When calling Horizon, you will be asked to provide your complete name, street address, email address and phone number where you can be reached during business hours. When sending product into Horizon, please include your RMA number, a list of the included items, and a brief summary of the problem. A copy of your original sales receipt must be included for warranty consideration. Be sure your name, address, and RMA number are clearly written on the outside of the shipping carton.

NOTICE: Do not ship LiPo batteries to Horizon. If you have any issue with a LiPo battery, please contact the appropriate Horizon Product Support office.

Warranty Requirements

For Warranty consideration, you must include your original sales receipt verifying the proof-of-purchase date. Provided warranty conditions have been met, your Product will be serviced or replaced free of charge. Service or replacement decisions are at the sole discretion of Horizon.

Non-Warranty Service

Should your service not be covered by warranty, service will be completed and payment will be required without notification or estimate of the expense unless the expense exceeds 50% of the retail purchase cost. By submitting the item for service you are agreeing to payment of the service without notification. Service estimates are available upon request. You must include this request with your item submitted for service. Non-warranty service estimates will be billed a minimum of ½ hour of labor. In addition you will be billed for return freight. Horizon accepts money orders and cashier's checks, as well as Visa, MasterCard, American Express, and Discover cards. By submitting any item to Horizon for service, you are agreeing to Horizon's Terms and Conditions found on our website http://www.horizonhobby.com/content/_service-center_render-service-center.

ATTENTION: Horizon service is limited to Product compliant in the country of use and ownership. If received, a non-compliant Product will not be serviced. Further, the sender will be responsible for arranging return shipment of the un-serviced Product, through a carrier of the sender's choice and at the sender's expense. Horizon will hold non-compliant Product for a period of 60 days from notification, after which it will be discarded.

WARRANTY AND SERVICE CONTACT INFORMATION

Country of Purchase	Horizon Hobby	Contact Information	Address
United States of America	Horizon Service Center (Repairs and Repair Requests)	servicecenter.horizonhobby.com/ RequestForm/	1608 Interstate Drive Champaign, Illinois, 61822 USA
	Horizon Product Support (Product Technical Assistance)	productsupport@horizonhobby.com	
		877-504-0233	
Sales	websales@horizonhobby.com	800-338-4639	
		EU	Horizon Technischer Service
Sales: Horizon Hobby GmbH	+49 (0) 4121 2655 100		

FCC INFORMATION

SPM5010: Contains FCC ID: BRWDAMTX12
FCC ID: BRWSR2100AL

This device complies with part 15 of the FCC rules. Operation is subject to the following two conditions:

1. This device may not cause harmful interference.
2. This device must accept any interference received, including interference that may cause undesired operation.

CAUTION: Changes or modifications not expressly approved by the party responsible for compliance could void the user's authority to operate the equipment.

This product contains a radio transmitter with wireless technology which has been tested and found to be compliant with the applicable regulations governing a radio transmitter in the 2.400GHz to 2.4835GHz frequency range.

SPMR5010 Contains FCC ID: BRWDAMTX12

Antenna Separation Distance

When operating your Spektrum transmitter, please be sure to maintain a separation distance of at least 5 cm between your body (excluding fingers, hands, wrists, ankles and feet) and the antenna to meet RF exposure safety requirements as determined by FCC regulations.

The illustrations show the approximate 5 cm RF exposure area and typical hand placement when operating your Spektrum transmitter.

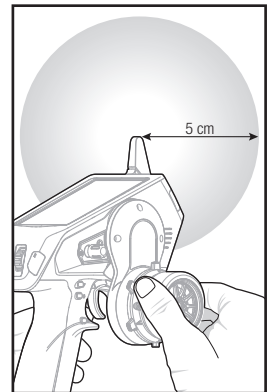

IC INFORMATION

SPM5010: Contains IC: 6157A-AMTX12
IC: 6157A-SR2100AL

This device complies with Industry Canada license-exempt RSS standard(s). Operation is subject to the following two conditions: (1) this device may not cause interference, and (2) this device

SPMR5010: Contains IC: 6157A-AMTX12

must accept any interference, including interference that may cause undesired operation of the device.

COMPLIANCE INFORMATION FOR THE EUROPEAN UNION



Horizon Hobby, LLC hereby declares that this product is in compliance with the essential requirements and other relevant provisions of the RED Directive.

A copy of the EU Declaration of Conformity is available online at:
<http://www.horizonhobby.com/content/support-render-compliance>.



Instructions for disposal of WEEE by users in the European Union



This product must not be disposed of with other waste. Instead, it is the user's responsibility to dispose of their waste equipment by handing it over to a designated collections point for the recycling of waste electrical and electronic equipment. The separate collection and recycling of your waste equipment at the time of disposal will help to conserve natural resources and ensure that it is recycled in a manner that protects human health and the environment. For more information about where you can drop off your waste equipment for recycling, please contact your local city office, your household waste disposal service or where you purchased the product.

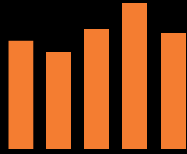

SPEKTRUM®

Innovative Spread Spectrum Technology

57840

© 2018 Horizon Hobby, LLC.

DSM, DSM2, DSMR, AVC and Active Vehicle Control are trademarks or registered trademarks of Horizon Hobby, LLC.

The Spektrum trademark is used with permission of Bachmann Industries, Inc.

All other trademarks, service marks and logos are property of their respective owners.

US 9,320,977

04/18