

TOP FLITE

GIANT P-51D MUSTANG ARF

**GOLD
ARF
EDITION**



Wingspan: 84.5 in [2145mm] **Wing Area:** 1245 sq in [80 dm²]
Weight: 19–24 lbs [8620–10890g]
Wing Loading: 35–44 oz/sq ft [107–134g/dm²]
Length: 73 in [1855mm] **Scale:** 19%
Radio: 6 to 9-channel with 10 to 11 servos
Engine: 2.1–2.8 cu in [34.5–46cc] two-stroke glow,
2.5–4.3 cu in [41–70cc] spark ignition (gas)

WARRANTY.....

Top Flite Models guarantees this kit to be free of defects in both material and workmanship at the date of purchase. This warranty does not cover any component parts damaged by use or modification. In no case shall Top Flite's liability exceed the original cost of the purchased kit. Further, Top Flite reserves the right to change or modify this warranty without notice. In that Top Flite has no control over the final assembly or material used for final assembly, no liability shall be assumed nor accepted for any damage resulting from the use by the user of the final user-assembled product. By the act of using the user-assembled product the user accepts all resulting liability. **If the buyer is not prepared to accept the liability associated with the use of this product, the buyer is advised to immediately return this kit in new and unused condition to the place of purchase.**

Top Flite Models • 3002 N Apollo Drive Suite 1 • Champaign, IL 61822 • Technical Assistance Call (217)398-8970 • productsupport@top-flite.com

READ THROUGH THIS INSTRUCTION BOOK FIRST. IT CONTAINS IMPORTANT INSTRUCTIONS AND WARNINGS CONCERNING THE ASSEMBLY AND USE OF THIS MODEL.

TABLE OF CONTENTS

INTRODUCTION	2
SAFETY PRECAUTIONS	3
DECISIONS YOU MUST MAKE	4
Engine recommendations	4
Radio equipment	4
Retractable landing gear	5
ADDITIONAL ITEMS REQUIRED	5
Hardware and Accessories	5
Adhesives and Building Supplies	5
Optional Supplies and Tools	5
KIT INSPECTION	6
ORDERING REPLACEMENT PARTS	7
ASSEMBLE THE WINGS	8
Hinge the ailerons and flaps	8
Mount the servos	10
Hook up the servos	12
Mount the retractors	13
Mount the landing gear covers and wheel covers	14
Install the air lines	15
Join the wing	16
Install the fixed landing gear	18
ASSEMBLE THE FUSELAGE	19
Hinge the elevators and rudder	19
Glue in the stabilizer	19
Install the cockpit	21
Mount the tail gear doors	23
Mount the retractable tail gear	24
Mount the fixed tail gear	26
Hook up the elevators and rudder	26
Mount the engine	27
Mount the cowling	28
Install the air tank	30
Install the fuel tank	30
Hook up the throttle	31
Hook up the air lines	32
Mount the kill switch	32
Finish the engine compartment	33
MOUNT THE SCALE DETAILS	33
Radiator air scoop	33
Wing fairing	34
Wing fillets	35
Machine guns	35
Engine exhaust	36
Canopy and pilot	36
Apply the decals	37
GET THE MODEL READY TO FLY	37

Complete the radio installation	37
Balance the model (CG)	38
Balance the model laterally	39
Check the control directions	39
Set the control throws	39
Balance propellers	40
Checklist	40
PREFLIGHT	41
Identify your model	41
Charge the batteries	41
Ground check	41
Range check	41
ENGINE SAFETY PRECAUTIONS	41
AMA SAFETY CODE	41
IMAA SAFETY CODE	42
FLYING	43
Takeoff	44
Flight	44
Landing	44
Engine mount template	47

INTRODUCTION

Congratulations and thank you for purchasing the Top Flite Giant P-51D Mustang ARF. With the high quality of today's ARFs, it was only a matter of time before Top Flite would develop an ARF warbird of their own—and what better place to start than with the most popular WWII warbird of all time—the P-51D Mustang! The Mustang's streamlined appearance combined with Top Flite's engineering expertise makes this one sweet model! If you are new to giant-scale warbirds, once over the initial apprehension of flying a valuable giant-scale model you'll realize its stable flight qualities and find yourself enjoying it for many flights to come. Although this Mustang is an ARF, it is *giant* and it is *scale*, so it's not exactly going to be ready to fly overnight! For the fastest, most pleasurable assembly experience, be certain to read all of the instructions and **read each step before proceeding**.

If you have web access, visit the Top Flite web site at www.top-flite.com for the latest technical updates or manual corrections. Open the "Airplanes" link, then select **Giant P-51D Mustang ARF**. If there are any changes or updates a "Tech Notice" box will appear in the upper left corner of the page. Open the box to view the information.

IMAA

The Top Flite Giant P-51D Mustang ARF is an excellent sport-scale model and is eligible to fly in IMAA events. The IMAA (International Miniature Aircraft Association) is an organization that promotes non-competitive flying of giant-scale models. If you plan to attend an IMAA event, order a copy of the **IMAA Safety Code** by contacting the IMAA at the address or telephone number below, or by logging on to their web site at

www.fly-ima.org/imaasancion.html.

IMAA

205 S. Hilldale Road

Salina, KS 67401

(913) 823-5569

SCALE COMPETITION

Though the giant P-51 is an ARF and may not have the same level of detail as an "all-out" scratch-built competition model, it is a scale model nonetheless and is therefore eligible to compete in the *Fun Scale* class in AMA competition. In *Fun Scale*, the "builder of the model" rule does not apply. To receive the five points for scale documentation, the only proof required that a full size aircraft of this type in this paint/markings scheme did exist is a single sheet such as a kit box cover from a plastic model, a photo, or a profile painting, etc. If a black-and-white photo is used, other written documentation of color must be provided. Contact the AMA for a rule book with full details. See page 3 for the AMA contact information.

If you would like photos of the full-size P-51D Mustang for scale documentation, or if you would like to study the photos to add more scale details, photo packs are available from:

Bob's Aircraft Documentation

3114 Yukon Ave

Costa Mesa, CA 92626

Telephone: (714) 979-8058 Fax: (714) 979-7279

e-mail: www.bobsairdoc.com

**PROTECT YOUR MODEL,
YOURSELF & OTHERS
FOLLOW THESE IMPORTANT
SAFETY PRECAUTIONS**

1. Your Top Flite Giant P-51D Mustang ARF should not be considered a toy, but rather a sophisticated, working model that functions very much like a full-size airplane. Because of its performance capabilities, the Giant P-51D Mustang ARF, if not assembled and operated correctly, could possibly cause injury to yourself or spectators and damage to property.
2. You must assemble the model **according to the instructions**. Do not alter or modify the model, as doing so may result in an unsafe or unflyable model. In a few cases the instructions may differ slightly from the photos. In those instances the written instructions should be considered as correct.
3. You must take time to **build straight, true and strong**.
4. You must use an R/C radio system that is in first-class condition, and a correctly sized engine and components (fuel tank, wheels, etc.) throughout the building process.
5. You must correctly install all R/C and other components so that the model operates correctly on the ground and in the air.
6. You must check the operation of the model before **every** flight to insure that all equipment is operating and that the model has remained structurally sound. Be sure to check devises or other connectors often and replace them if they show any signs of wear or fatigue.
7. If you are not already an experienced R/C pilot, you should fly the model only with the help of a competent, experienced R/C pilot.

8. While this kit has been flight tested to exceed normal use, if the plane will be used for extremely high stress flying, such as racing, the modeler is responsible for taking steps to reinforce the high stress points.

9. **WARNING:** The cowl, radiator air scoop, and other parts included in this kit are made of fiberglass, the fibers of which may cause eye, skin and respiratory tract irritation. Never blow into a part (air scoop, cowl) to remove fiberglass dust, as the dust will blow back into your eyes. Always wear safety goggles; a particle mask and rubber gloves when grinding, drilling and sanding fiberglass parts. Vacuum the parts and the work area thoroughly after working with fiberglass parts.

NOTE: We, as the kit manufacturer, provide you with a top quality kit and great instructions, but ultimately the quality and flyability of your finished model depends on how you build it; therefore, we cannot in any way guarantee the performance of your completed model, and no representations are expressed or implied as to the performance or safety of your completed model.

Remember: Take your time and follow the instructions to end up with a well-built model that is straight and true.

If you have not flown this type of model before, we recommend that you get the assistance of an experienced pilot in your R/C club for your first flights. If you're not a member of a club, your local hobby shop has information about clubs in your area whose membership includes experienced pilots.

In addition to joining an R/C club, we strongly recommend you join the AMA (Academy of Model Aeronautics). AMA membership is required to fly at AMA sanctioned clubs. There are over 2,500 AMA chartered clubs across the country. Among other

benefits, the AMA provides insurance to its members who fly at sanctioned sites and events. Additionally, training programs and instructors are available at AMA club sites to help you get started the right way. Contact the AMA at the address or toll-free phone number below:



Academy of Model Aeronautics

5151 East Memorial Drive
Muncie, IN 47302-9252
Tele: (800) 435-9262
Fax (765) 741-0057

Or via the Internet at: <http://www.modelaircraft.org>

DECISIONS YOU MUST MAKE

This is a partial list of items required to finish this model that may require planning or decision making before starting to build. Order numbers are provided in parentheses.

ENGINE RECOMMENDATIONS

When considering engines for this model, refer to the engine size recommendations on the cover of the manual. Spark-ignition ("gas") engines are most popular with large-scale warbirds such as this. One advantage of a gas engine is economy—gas engines tend to consume less fuel than glow engines. Gasoline costs less than glow fuel as well. Additionally, gas engines deposit little exhaust residue on the model. Among other engines, this model was flight-tested with a U.S. Engines™ 41cc engine. The U.S. 41 provides adequate power and fits the P-51 in a scale-like manner, but pilots who wish to perform more aggressive maneuvers should consider engines nearer the upper end of the recommended range.

Note: Instructions for mounting every possible engine cannot be incorporated into this manual. Although there are several glow engines suitable for powering the giant P-51, the U.S. Engines 41cc is featured. Modelers using another engine may refer to the instructions as a guide for mounting their engine in a similar way. If using the U.S. 41, the following items will be required:

- Great Planes Gasoline Engine Mount (GPMG2000)
- (4) 1/4-20 x 1-1/2" [38mm] hex-head bolts and 1/4" [6mm] flat washers
- Prop Reamer (GPMQ5005)

Per the IMAA Safety Code, magneto spark-ignition engines must have a coil-grounding switch on the aircraft to stop the engine and

prevent accidental starting. The switch must be operated manually (without the use of the transmitter) and accessible by the pilot and assistant. If using a spark-ignition engine, refer to **Mount the Kill switch** on page 32 for details and a list of items used.

RADIO EQUIPMENT

The radio equipment and number of channels required to fly the Top Flipe Giant P-51 depend on the capabilities of your transmitter and how the servos will be connected. Two servos are required to operate the elevators. However, the servos must move in opposition, so linking them with a Y-connector will not work. The elevator servos must either be electronically mixed using an additional channel, or be linked by a device such as a Futaba® SR-10 Synchronized Servo Reverser (FUTM4150) that will mix the servos with the capability of reversing one of them.

The rudder servo and tail steering servo have the same requirement, so they too must either be electronically mixed through an additional channel, or connected via a Futaba Synchronized Servo Reverser.

The Giant P-51 requires a servo to operate the air control valve if using retract, a throttle servo, two flap servos and two aileron servos. Servos with a minimum of 50 oz-in [3.9 kg-cm] of torque are required for operating the elevators, rudder and ailerons. Standard servos may be used everywhere else. If using a spark-ignition engine, a servo-operated electronic engine kill switch may also be used (this would be in addition to the IMAA-required, manually operated engine kill switch). A servo-operated kill switch is only really necessary for engines that do not reliably shut off by closing the carburetor, but could also serve as a backup.

<u>Function</u>	<u>Servos required</u>
Elevators.....	2 (min. 50 oz-in torque)
Rudder.....	1 (min. 50 oz-in torque)
Ailerons.....	2 (min. 50 oz-in torque)
Flaps.....	2
Tail steering.....	1
Throttle.....	1
Air control valve.....	1
Optional Kill switch for gas engine.....	1
Total:	10-11 servos

A receiver battery with a minimum of 1,000 mAh is recommended for flying the giant Mustang. In the model shown in this instruction manual a Futaba NR4F 1,500 mAh battery pack (FUTM1285) is shown. Additionally, the battery voltage should be checked before every flight to be certain it has enough "charge."

In addition to the servos (and Synchronized Servo Reverser if used), the following items (or similar items) are also required. The order numbers shown (in parentheses) are for Futaba servos.

- (2) 24" [610mm] servo extension wires for the aileron servos (FUTM2721)
- (1) Dual servo extension cord for aileron servos (FUTM4130)
- (1) Y-harness for flap servos (HCAM2751)
- (4) 6" [150mm] servo extensions (battery-1, aileron-1, elevator-2) (HCAM2701 for Futaba)

Note: The length and quantity of servo extensions and Y-connectors may vary depending on the brand of radio you are using and the radio installation.

RETRACTABLE LANDING GEAR

The Top Flite Giant P-51 ARF may be assembled with either the included fixed landing gear or retractable landing gear. If fixed landing gear is used no other items will need to be purchased to install the gear. If you wish to install retractable landing gear, this model is designed for Robart pneumatic retracts. Following is the complete list of items required to install the Robart retracts:

- (1) Robart #622-5 Top Flite P-51 pneumatic retractable main landing gear (ROBQ1635)
- (1) Robart #160LWC retractable tail gear assembly (ROBQ2225)
- (1) Robart #157VRX Large-Scale Deluxe Air Control Kit—includes pressure vessel, air line tubing, variable-rate air valve, T-fittings (ROBQ2305)
- 10' [3.5m] red & purple #169 Pressure tubing (ROBQ2369)
- (1 pkg.) #190 Air Line Quick Disconnects (ROBQ2395)
- (2) Du-Bro No. 500TL Treaded lightweight wheel (DUBQ0847)
- Size "F" [6.5mm] or 17/64" [6.8mm] drill (to enlarge the hole in the wheels for the axles)
- 1-3/4" [45mm] tailwheel (GPMQ4220 –2/pkg)

Note: There may be other main wheels that could be used with the Robart retracts, but the Du-Bro wheels listed above are the only ones recommended because they are narrow and will fit in the wing.

An air pump will also be required to pressurize the air tank. The Robart hand pump could be used, but is not practical because of the large capacity of the air tank in this model. A small, 12V electric pump is recommended and can be purchased at any automotive or hardware store.

ADDITIONAL ITEMS REQUIRED

HARDWARE AND ACCESSORIES

In addition to the items listed in the "**Decisions You Must Make**" section, following is the list of hardware and accessories required to finish the Top Flite Giant P-51D Mustang ARF. Order numbers are provided in parentheses.

- R/C foam rubber (1/4" [6mm] (HCAQ1000) or 1/2" [13mm] (HCAQ1050))
- 2' [600mm] large silicone fuel tubing for glow engines (GPMQ4133)
- 3' [900mm] gasoline fuel tubing for gas engines (GPMQ4135)
- Williams Bros. #625 3" (1/4-scale) standard pilot (WBRQ22625)
- Modeling paints and paint brushes for painting pilot
- Propeller and spare propellers suitable for your engine

ADHESIVES AND BUILDING SUPPLIES

In addition to common hobby tools and household tools, this is the "short list" of the most important items required to build the Top Flite Giant P-51D Mustang ARF. **Great Planes Pro™ CA and Epoxy glue are recommended.**

- 30-minute epoxy (GPMR6047)
- 1 oz. Medium CA (GPMR6008)
- 1 oz. Thin CA (GPMR6002)
- CA applicator tips (HCAR3780)
- CA Activator (2 oz. [57g] spray bottle (GPMR6035) or 4 oz. [113g] aerosol (GPMR634))
- Threadlocker thread locking cement (GPMR6060)

- Hobby torch or soldering iron
- Silver solder w/flux (GPMR8070)
- Drill bits: **1/16"** [1.6mm], **3/32"** [2.4mm], **7/64"** [2.8mm] (**or 1/8"** [3.2mm]), **1/8"** [3.2mm], **3/16"** [4.8mm], **#9** [5.0mm], **1/4"** [6.4mm], **size "F"** [6.5mm] (**or 17/64"** [6.8mm]), **17/64"** [6.8mm] (**or 9/32"** [7.2mm])

- Small metal file
- Acrylic paint and paint brushes for painting pilot (found at craft stores)
- Stick-on segmented lead weights (GPMQ4485)
- #1 Hobby knife (HCAR0105)
- #11 blades (5-pack, HCAR0211)
- #11 blades (100-pack, HCAR0311)
- Non-elastic string for stab alignment (such as K & S #801 Kevlar thread (K+SR4575))
- Fine-point felt-tip pen (Top Flite® Panel Line Pen (TOPQ2510))
- Masking tape (TOPR8018)
- Curved-tip canopy scissors for trimming plastic parts (HCAR0667)
- Aluminum paint and airbrush or paint brush (for painting cockpit)
- Robart Super Stand II (ROBP1402)

OPTIONAL SUPPLIES AND TOOLS

Here is a list of optional tools mentioned in the manual that will help you build the Top Flite Giant P-51D Mustang ARF.

- R/C-56 canopy glue (JOZR5007)
- CA debonder (GPMR6039)
- 3M 77 spray adhesive (MMMR1990)
- Epoxy brushes (6, GPMR8060)
- Mixing sticks (50, GPMR8055)
- Mixing cups (GPMR8056)

(Continued on page 8)

KIT INSPECTION

Before starting to build, take an inventory of this kit to make sure it is complete, and inspect the parts to make sure they are of acceptable quality. If any parts are missing or are not of acceptable quality, or if you need assistance with assembly, contact **Product Support**. When reporting defective or missing parts, use the part names exactly as they are written in the kit contents list on this page.

Top Fite Product Support
3002 N Apollo Drive Suite 1
Champaign, IL 61822
Telephone: (217) 398-8970
Fax: (217) 398-7721
E-mail:

PARTS PHOTOGRAPHED

1. Fuselage
2. Rudder
3. Canopy
4. Fiberglass cowl
5. Fiberglass air scoop
6. Fiberglass wing fairing
7. Cockpit parts
8. Tail gear doors
9. Wing joiner
10. Landing gear covers
11. Wings with flaps & ailerons
12. Horizontal stabilizer with elevators
13. (2) Fiberglass wing fillets
14. (2) Plastic machine guns
15. (2) Plastic engine exhaust outlets
16. (8) Engine mount spacers
17. Wheel covers
18. Servo hatches

PARTS NOT PHOTOGRAPHED

- sheet-metal screws:**
- (34) #2 x 3/8" (24-wing servo hatches, 6-landing gear covers, 4-wheel covers)
 - (28) #4 x 1/2" Phillips-head (24-all control horns except rudder, 4-tail gear mounting)
 - (8) #4 x 5/8" Phillips-head (4-rudder control horn, 4-cowl mounting)
 - (12) #6 x 1/2" (landing gear mounting)
 - (8) #2 x 1/2" (2-landing gear covers, 2-fuel tank floor, 4-forward servo tray)
 - (8) #2 x 3/16" (canopy mounting)

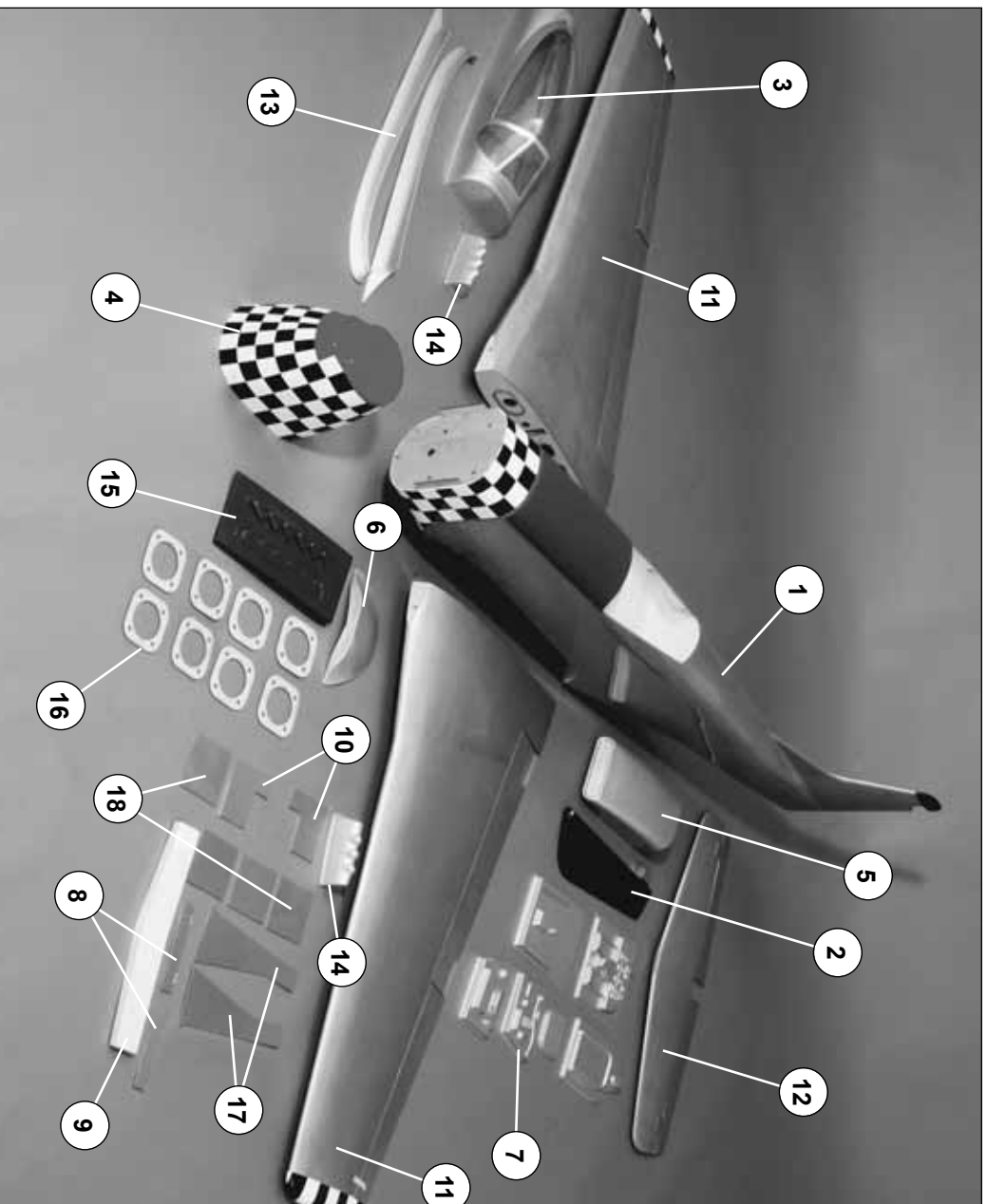

machine screws:

- (4) 2-56 x 3/8" (tail gear door brackets)
- (4) 4-40 x 3/8" (4-cowl reinforcement glue on)

pushrods:

- (4) 4-40 x 4" wire pushrods (2-ailerons, 2-flaps)
- (3) 4-40 x 36" wire pushrods (2-elevators, 1-rudder)
- (6) 3/16" pushrod guide tubes (5-factory-installed in fuselage, 1-throttle)
- (1) 36" white, plastic pushrod (throttle)
- (1) 2-56 x 4" pushrod (air valve)

nylon hardware:

- (7) large control horns (2-ailerons, 2-flaps, 2-elevators, 1-rudder)
- (2) 1/4-20 x 2" nylon wing bolts
- (1) ball link (throttle)
- (2) nylon clevis (1-throttle, 1-air valve)
- (14) pinned hinge points (for ailerons and flaps)

metal hardware:

- (7) 4-40 threaded metal clevises (2-ailerons, 2-flaps, 2-elevator, 1-rudder)
- (7) Large solder clevises (2-ailerons, 2-flaps, 2-elevator, 1-rudder)

nuts:

- (11) 4-40 hex nuts (7-clevis jam nuts, 4-cowl reinforcements)
- (6) 1/4-20 blind nuts (factory-installed – 4-engine mounting, 2-wing bolts)
- (4) 2-56 hex nuts (tail gear door brackets)
- (3) 0-80 hex nuts (2-ball link balls on tail steering arm, 1-throttle on engine)

washers:

- (6) #2 washers (4-wheel covers, 2-fuel tank floor)
- (4) #4 washers (4-cowl mounting)
- (4) #4 lock washers (4-cowl mounting)

other:

- (2) 3/8" [9.5mm] heat shrink tubing (for servo extensions)
- (1) 1/2" [13mm] heat shrink tubing (for servo extensions)
- (16) silicone retainers (clevises)
- (1) 2" x 9" [50 x 230mm] CA hinge strip
- (3) 0-80 ball link balls (2-tail steering arm, 1-throttle)
- (4) size 10 rubber bands (tail gear doors)
- (1) 32 oz. [960cc] Great Planes fuel tank and hardware
- (2) #64 rubber bands (for fuel tank mounting)
- (1) 2-56 x 1" [25mm] threaded rod (throttle pushrod)
- (2) Decal sheets
- (1) Velcro® strap
- (2) plywood air tank mounting rings
- (1) plywood air tank former
- (2) 2" x 2" [50 x 50mm] plywood wing bolt plates (w/1/4" hole)
- (6) plywood air line guides
- (1) plywood air valve mount
- (6) 1/16" x 7/8" [1.5 x 22mm] plywood cowl reinforcements (for mounting screws)
- (6) 1/2" x 13/16" x 13/16" [12 x 20 x 20mm] hardwood cowl mounting blocks
- (8) 3/8" x 13/16" x 13/16" [10 x 20 x 20mm] hardwood servo mounting blocks
- (8) 1/2" x 1/2" x 7/8" [13 x 13 x 23mm] wheel cover mounts (4 req'd., 4 spares)
- (1) hardwood "L" block (for tail gear door)
- (2) 1/16" [2mm] plywood large rubber band hooks

(with spacer)

- (2) 1/16" [2mm] plywood small rubber band hook (with spacer)
- (2) 3/8" x 1-3/4" [10mm x 45mm] hardwood wing dowels
- (2) plywood aft servo trays
- (2) plywood forward servo trays
- (1) plywood fuel tank mount
- (2) bent aluminum tail gear door brackets
- (4) nylon pinned hinges (for tail gear doors)
- (1) 1/8" x 1/4" x 2" [3 x 6 x 50mm] balsa stick (for gluing on instrument panel)
- (1) 1/4" x 1/4" x 12" [6 x 6 x 300mm] hardwood stick (for forward servo tray)
- (1) 1/16" x 3/8" x 1-9/16" [1 x 10 x 40mm] plywood tail gear door stop
- (1) 1/8" x 12" hardwood dowel (for cowl mount blocks)
- (2) 3/4" x 3/4" x 7" [20 x 20 x 180mm] balsa sticks (for gluing on engine exhaust stacks)

Cockpit parts (photographed)

- instrument panel
- floor
- seat bottom
- seat back
- right panel
- left panel
- wing joiner

Pull/Pull cable contents:

- (1) Steel cable
- (4) Copper tubes (swages)
- (2) 2mm metal clevises
- (2) 2mm brass couplers
- (2) 2mm nuts

Fixed landing gear components:

- (2) 5" [125mm] main wheels
- (2) landing gear mounts
- (4) metal straps
- (8) 3 x 10mm screws
- (2) main landing gear wires
- (4) 6mm wheel collars
- (3) 1/8" wheel collars
- (8) 3mm set screws

- tail gear mount
- tail gear wire
- 2" [45mm] tail wheel steering arm
- 1.5mm hex wrench

ORDERING REPLACEMENT PARTS

To order replacement parts for the Top Flite Giant P-51D Mustang ARF, use the order numbers in the **Replacement Parts List** that follows. Replacement parts are available only as listed. Not all parts are available separately (an aileron cannot be purchased separately, but is only available with the wing kit). Replacement parts are not available from Product Support, but can be purchased from hobby shops or mail order/Internet order firms. Hardware items (screws, nuts, bolts) are also available from these outlets. If you need assistance locating a dealer to purchase parts, visit www.top-flite.com and click on "Where to Buy." If this kit is missing parts, contact **Product Support**.

REPLACEMENT PARTS LIST

Description	How to purchase
Missing pieces	Contact Product Support
Instruction manual	Contact Product Support
Full-size plans	Not available

**Contact your hobby supplier
to purchase these items**

- TOPA1650 Fuse set** (fuselage, wing fairings, tail wheel doors, brackets, etc.)
- TOPA1651 Wing set** (ailerons, flaps, fiberglass air scoop, guns, wheel covers)
- TOPA1652 Tail set**
- TOPA1653 Cowl (w/exhausts)**
- TOPA1654 Cockpit kit**
- TOPA1655 Decal set**
- TOPA1656 Canopy**

(Continued from page 5)

- Scale Warbird Template (TOPQ2187)
- 36" [1m] metal ruler (HCAR0475)
- Hobbico Duster™ can of compressed air (HCAR5500)
- Denatured alcohol (for epoxy clean up)
- Receiver mounting box (GPM1010)
- Switch & Charge Jack Mounting Set (GPM1000)
- Fuel filler valve for glow fuel (GPMQ4160)
- Fuel filler valve for gasoline (GPMQ4161)
- Rotary tool such as Dremel®
- Rotary tool reinforced cut-off wheel (GPMR8200)
- AccuThrow™ Deflection Gauge (GPMR2405)
- CG Machine™ (GPMR2400)
- Laser incidence meter (GPMR4020)
- 36" [910mm] bar for incidence meter (GPMR4021)
- Precision Magnetic Prop Balancer™ (TOPQ5700)

COVERING TOOLS

- 21st Century® sealing iron (COVR2700)
- 21st Century iron cover (COVR2702)
- 21st Century trim seal iron (COVR2750)

The Top Flite Giant P-51D Mustang ARF is factory covered with Top Flite Monokote® film. Should repairs ever be required, following is a list of colors used on this model and order numbers for 6' [1.8m] rolls.

- | | |
|--|----------------------------------|
| <input type="checkbox"/> Aluminum | TOPQ0205 (base color) |
| <input type="checkbox"/> Flat olive drab | TOPQ0510 (anti-glare) |
| <input type="checkbox"/> Black | TOPQ0208 (rudder, nose checkers) |
| <input type="checkbox"/> White | TOPQ0204 (nose checkers) |
| <input type="checkbox"/> True red | TOPQ0227 (pin striping) |

Note: The stabilizer and wing incidences and engine thrust angles have been factory-built into the giant Mustang. However, some technically-minded modelers may wish to check these measurements anyway. To view this information, visit the web site at and click on "Technical Data." Due to manufacturing tolerances which will have little or no effect on the way the model will fly, there may be slight deviations between your model and the published values.

METRIC CONVERSIONS

To convert inches to millimeters, multiply inches by 25.4 (25.4mm = 1")

1/64" = .4mm	1" = 25.4mm
1/32" = .8mm	2" = 50.8mm
1/16" = 1.6mm	3" = 76.2mm
3/32" = 2.4mm	6" = 152.4mm
1/8" = 3.2mm	12" = 304.8mm
5/32" = 4mm	15" = 381mm
3/16" = 4.8mm	18" = 457.2mm
1/4" = 6.4mm	21" = 533.4mm
3/8" = 9.5mm	24" = 609.6mm
1/2" = 12.7mm	30" = 762mm
5/8" = 15.9mm	36" = 914.4mm
3/4" = 19mm	

ASSEMBLE THE WINGS

Hinge the ailerons and flaps

Start with the left wing so yours matches the photos the first time through.



1. Lay a few paper towels on top of each other and cut them into small squares. These paper towel squares will come in handy for wiping away excess epoxy throughout the assembly process (and will save you from wasting whole paper towels!).

2. Separate the aileron and flap from the wing by peeling off the masking tape holding them together. Use a paper towel square dampened with naphtha lighter fluid or similar solvent to remove any glue left from the tape.



3. If necessary, use a covering iron with a covering sock to go over the wing, flap and aileron to remove

wrinkles. The best way is to glide the iron over the covering until the wrinkles disappear, then go over the area again, pushing down on the iron to bond the covering to the wood. If the wrinkles don't go away, the balasa in that area may be bending inward. If this is happening, don't press down. Simply let the heat of the iron shrink the covering. If the wrinkles momentarily disappear, then immediately reappear, the iron may be too hot, thus causing air bubbles. Lower the temperature of the iron or use a sharp #11 blade to puncture several holes in the covering, then reheat. The suggested iron temperature is around 360 degrees F.

4. Cut the covering from the holes for the hinge points in the trailing edge of the wing and the leading edge of the flap and aileron. There are three holes for the aileron and four holes for the flap. Note that the holes in the flap and aileron are elongated.

5. Shorten one of the pinned hinge points by cutting the last segment off one end. This hinge will be for the outermost hole in the aileron.

HINGE PIVOT POINT

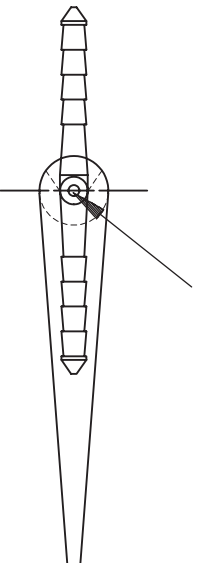

6. Without using any glue, install three hinges into the aileron. The one shortened in the previous step goes in the hole nearest the outer tip. Note that the

pivot point of each hinge must align with the **center** of the radius on the leading edge. To achieve this alignment the hinges will be fairly deep in the aileron. Also note that the hinges must be perpendicular to the leading edge. If necessary, use an electric drill to run a 3/16" [4.8mm] drill bit into the holes to achieve this alignment. Be careful not to drill through the sheeting over the top and bottom of the aileron.

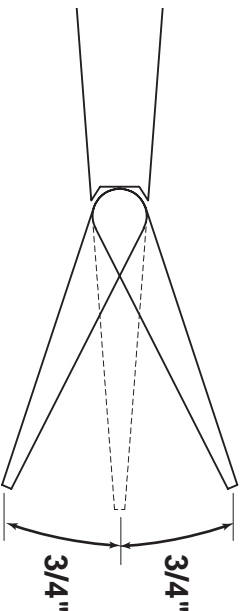
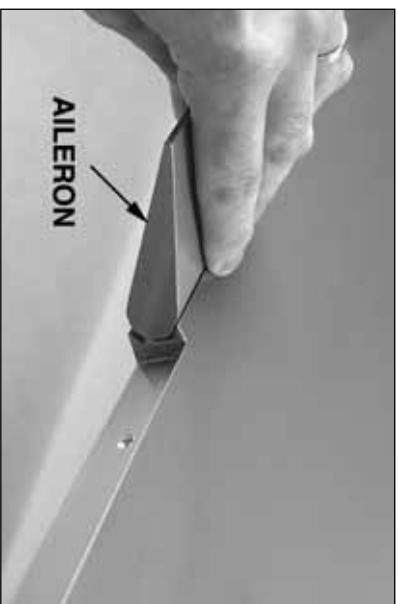

7. Again without glue, test fit the aileron to the wing. Move it up and down a few times to align the hinges—it doesn't have to move very far—only 3/4" [19mm] up and 3/4" [19mm] down (measured at the widest part of the aileron at the trailing edge as shown in the photo). If there is too much resistance, or if you are not able to move the aileron up and down 3/4" [19mm], widen the gap between the aileron and the wing by pulling the aileron from the wing slightly, or enlarge the hinge openings in the aileron.



8. Still using no glue, test fit the flap to the wing the same way. 2-1/8" [55mm] of down deflection is required (measured at the widest part of the flap).

We'll glue on the flap and aileron separately. This way you will have plenty of working time for the epoxy.

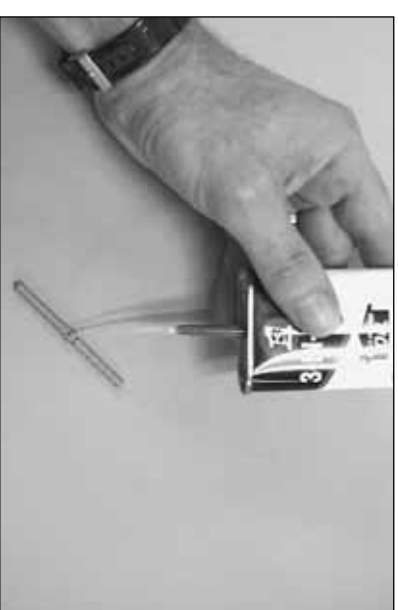

9. Remove all the hinges. Add a **small** drop of oil to the pivot point on the aileron hinges.



- 10. Mix up some 30-minute epoxy and microballoons (if using mixing cups, approximately 1/4 oz. of microballoons added to 1/8 oz. of mixed epoxy is recommended). Use a piece of music wire to **thoroughly** apply the mixture in the holes in the wing and aileron. Use the wire to get the epoxy out of the opening of the holes in the aileron so it doesn't get into the hinge pins. Wipe away any epoxy around the outside of the holes with a couple of the small paper towel squares.



- 11. Use the wire to apply epoxy to the ends of the aileron hinges that go into the aileron. Insert each hinge and wipe away any epoxy that squeezes out of the holes.

- 12. Apply epoxy to the other end of the hinges. Join the aileron to the wing, pushing the hinges only about 3/4 of the way in. Use small strips of balsa or toothpicks to wipe away epoxy that squeezes out, then fit the aileron the rest of the way in.

- 13. Move the aileron up and down a few times to align the hinges and make certain you are getting enough deflection. Use a small piece of masking tape to hold the tip of the aileron in alignment with the tip of the wing. Allow the epoxy to fully harden.
- 14. Mix up another batch of epoxy and microballoons and join the flap to the wing the same way.
- 15. Allow the epoxy to **fully** harden before moving the aileron or flap. After the epoxy has fully hardened, "break" them loose by rapidly moving them up and down a couple of times.

- 16. Join the right aileron and flap to the right wing the same way.

Mount the servos

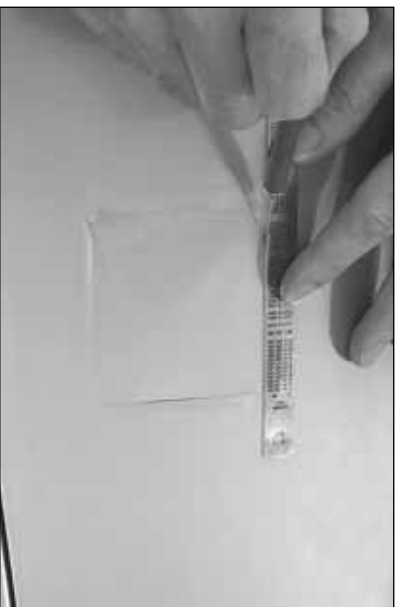

- 1. Use a straightedge and a hobby knife to cut the covering approximately 1/4" [5mm] inside the edges of one of the openings for the servo hatch in the bottom of one of the wing halves. (You can save the piece of Monokote you cut out for small patches or repairs.)

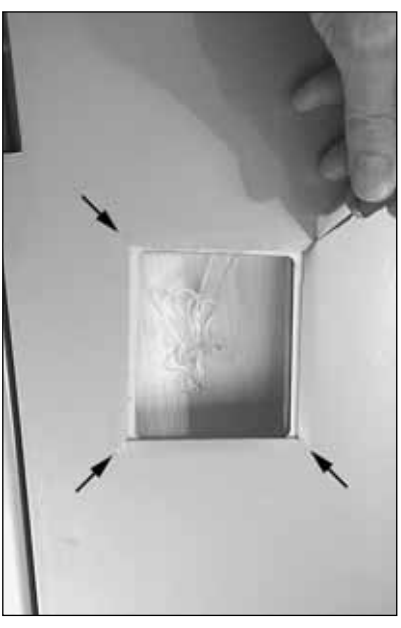

- 2. Sit the covering up to the corners (indicated by the arrows).

- 3. Cut the remaining three servo hatch openings the same way.



- 4. Use a trim iron to iron the covering to the edges of the openings and to the plywood ledge inside.



- 5. Notice the correct locations of the aileron and flap servos on the inside of the hatches (indicated by the dashed lines). Refer to these photos when mounting the servos to the hatches in the following steps.

Now it's time to mount the servos to the hatch covers. Start with the left aileron servo.

Refer to this photo for the following seven steps.

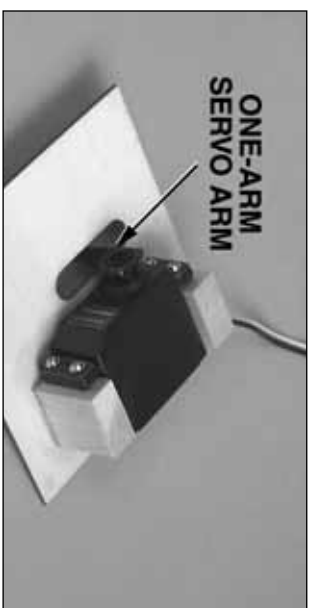

- 6. Make a one-arm servo arm by cutting off the unused arms. (The outer hole in the servo arm must be at least 3/4" [19mm] from the center of the output shaft.)
- 7. Place the servo on the aileron hatch cover as shown, then place the arm on the servo (remember, this is for the **left** aileron).

- 8. Take the servo off the hatch cover. Position two 3/8" x 13/16" x 13/16" [10 x 20 x 20mm] hardwood **servo mounting blocks** on the servo (one of the blocks may have to be trimmed to accommodate the servo wire where it comes out of the servo). The wood grain in the blocks runs vertically.

- 9. Place a piece of thin cardstock (such as from the header card that some servos are packaged on) under the servo and between each mounting block and the servo. Later, the cardstock will be removed, thus providing adequate spacing for vibration isolation.

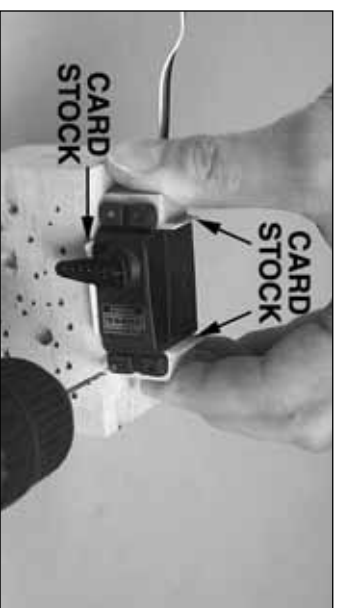

- 10. Drill 1/16" [1.6mm] holes through the blocks for the mounting screws. Mount the servo to the

blocks with the screws that came with the servo. Remove the cardstock spacers.

- 11. Mount the left flap servo to two more mounting blocks the same way.



- 12. Mix some 30-minute epoxy for gluing the mounting blocks to the hatch covers. Smear a thin coat of epoxy on the inside of the hatch covers in the area where the mounting blocks will be glued. Thoroughly coat the ends of the blocks that contact the covers. Wait a few minutes for the mounting blocks to absorb the epoxy, then recoat with the epoxy. Position the servos with the mounting blocks on the covers so the servo arms are **centered** in the openings. Use clamps or weights to hold the mounting blocks to the hatch covers until the epoxy hardens.

- 13. After the epoxy has fully hardened, temporarily remove the servos from the mounting blocks. Add a few drops of thin CA to the screw holes and allow to **fully** harden. Remount the servos to the blocks with the screws.

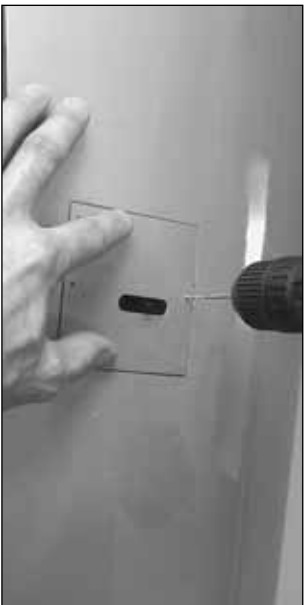

- 14. Place the hatch covers with the servos in the wing. Be certain the hatch covers are positioned correctly as shown in the photos back at step 5. Drill six 1/16" [1.6mm] evenly spaced holes through the hatch covers into the wing. Enlarge the holes in the hatch covers only with a 3/32" [2.4mm] drill.



- 15. Connect a 24" [610mm] servo extension wire to the aileron servo. Cut one of the pieces of 3" [75mm] heat shrink tubing supplied with this kit in half. Slip the tubing over the connection between the servo and the extension wire, then carefully shrink the tubing by heating with a heat gun.



- 16. Use the string in the wing to pull the aileron wire through the wing. Mount the aileron hatch with six #2 x 3/8" [9.5mm] screws.

- 17. Guide the flap servo wire through the wing alongside the aileron servo wire. Mount the flap hatch with six more #2 x 3/8" [9.5mm] screws.
- 18. Mount the aileron and flap servos and hatches in the right wing the same way.

Hook up the servos

Do the left aileron first.

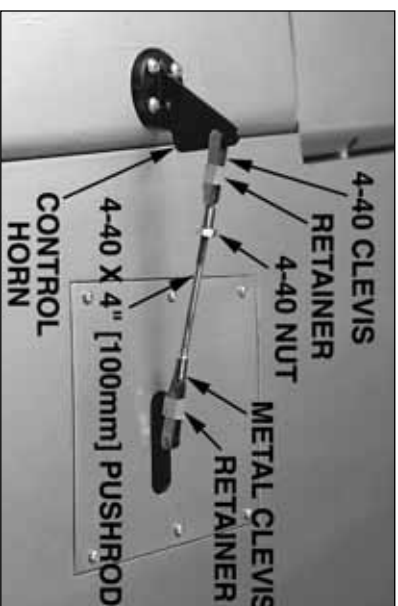

- 1. Referring to the photo above, cut the aileron pushrod to the correct length, then solder it to a large, non-threaded metal clevis using the techniques described in the following **Hot Tip**.

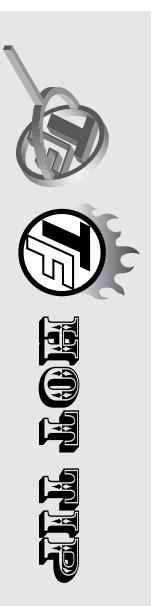

HOW TO SOLDER

1. Use denatured alcohol or other solvent to thoroughly clean the pushrod. Roughen the end of the pushrod with coarse sandpaper where it is to be soldered.

2. Apply a few drops of soldering flux to the end of the pushrod, then use a soldering iron or a torch to heat it. "Tin" the heated area with **silver solder** (GPMRR8070) by applying the solder to the end. The heat of the pushrod should melt the solder—not the flame of the torch or soldering iron—thus allowing the solder to flow. The end of the wire should be coated with solder all the way around.

3. Place the clevis on the end of the pushrod. Add another drop of flux, then heat and add solder. The same as before, the heat of the parts being soldered should melt the solder, thus allowing it to flow. Allow the joint to cool naturally without disturbing. Avoid excess blobs, but make certain the joint is thoroughly soldered. The solder should be shiny, not rough. If necessary, reheat the joint and allow to cool.

4. Immediately after the solder has solidified, but while it is still hot, use a cloth to quickly wipe off the flux before it hardens. **Important:** After the joint cools, coat with oil to prevent rust. **Note:** Do not use the acid flux that comes with silver solder for electrical soldering.



This is what a properly soldered clevis looks like—shiny solder with good flow, no blobs, flux removed.

- 2. Thread a 4-40 nut and a 4-40 metal clevis to the other end of the pushrod. Connect the pushrod to the aileron servo arm and to a **large control horn**. Position the horn on the aileron directly behind the arm. The base of the horn should be set back from the trailing edge of the wing 1/4" [6mm]. Drill 3/32" [2.4mm] holes into the aileron for the horn. Mount the horn with four #2 x 1/2" [13mm] screws. Adjust the length of the pushrod by turning the clevis so the aileron will be neutral when the servo is centered (this will be fine-tuned later when setting up the radio, so there is no need to tighten the 4-40 nut to the clevis until then).

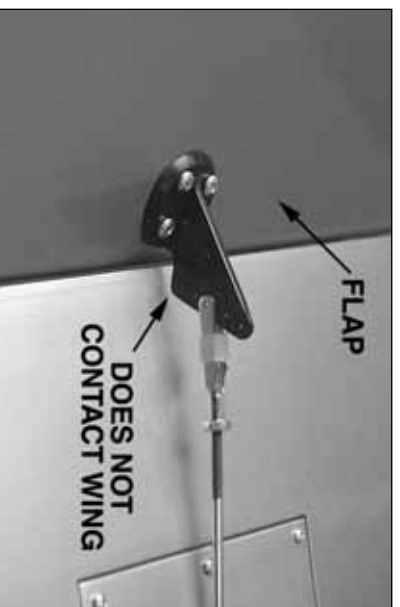

- 3. Hook up the flap the same way. Note that the flap is retracted ("up") when the servo arm is rotated aft (not when the servo arm is centered). Be certain the control horn is set back far enough so it will not contact the wing at full flap deflection.

- 4. One last **IMPORTANT** step: remove the screws from both servo hatches and both control horns. Add a few drops of thin CA to all the holes, allow to **fully** harden. Remount the hatches and horns.

- 5. Mount the hatches and hook up the aileron and flap on the right wing the same way.

Mount the retracts

Note: Steps with an "R" are for mounting retracts. Steps with an "F" are for mounting the included fixed landing gear. The fixed gear will not be installed until after the wings have been joined. If mounting the fixed landing gear proceed to "Join the wings" on page 16.

Install the left retract first.



- R1. The same as the covering was cut from the aileron hatches, cut the covering from the landing gear opening 1/4" [5mm] inside the edges all the way around the opening. Use a trim iron to iron down the covering.

- R2. Enlarge the hole in the Du-Bro 5" [127mm] wheels (not included) with a size "F" [6.5mm] (or 17/64" [6.8mm]), drill (size F will provide the best fit, but a 17/64" hole is suitable).



- R3. Cut the 1/4-20 bolts that come with the Robart retracts to a length of 1-3/4" [45mm]. Slip the

washer followed by the wheel and a nut onto the bolt. Add a small drop of threadlocker to the nut, then tighten the assembly to the retract strut, simultaneously adjusting the spacing of the nut so the wheel will roll freely.

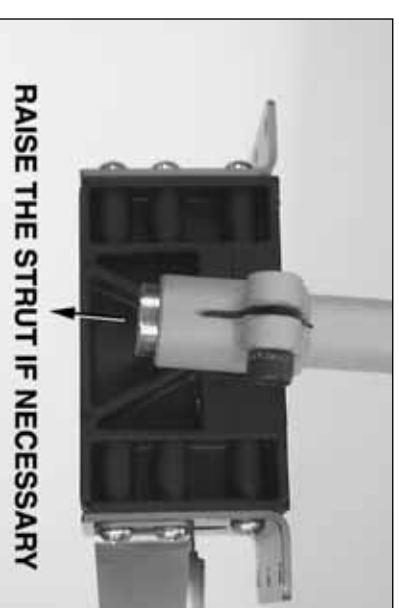

- R4. Test fit the retract unit with the wheel into the wing. Position the retract so the wheel is centered in the wheel well. It will probably be necessary to raise the strut into the retract body approximately 1/8" [3mm] to achieve the correct spacing all the way around.

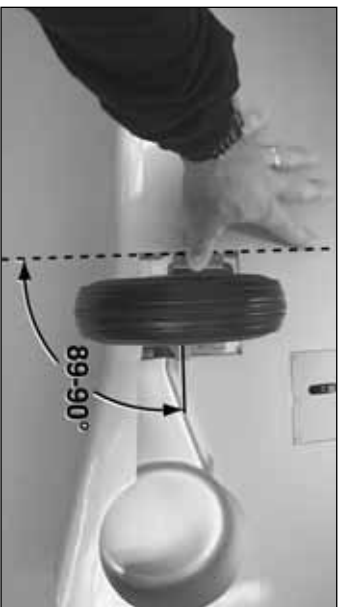

- R5. Extend the retract. View the wheel from directly above. Adjust the strut so the wheel has zero, to one degree of tow-in. Lock the strut in position by securely tightening the bolt on top of the strut.
- R6. Double-check to be certain the wheel will fully retract into the wing. Extend the unit to make certain it does not interfere with any part of the wing and the unit is operating smoothly.

- R7. Hold the retract body in the wing. Using the mounting holes as a guide, drill 7/64" [2.8mm] (or 1/8" [3.2mm]) holes into the rails. **CAUTION:** Do not inadvertently drill into the air cylinder when you get to the middle hole! Mount the retract with six #6 x 1/2" [13mm] screws.

- R8. Return to step R1 and mount the other retract in the right wing the same way.

Mount the landing gear covers and wheel covers (for retractable landing gear only).

The wheel covers on this model represent the ones on the full-size P-51, but are not 100% scale. They achieve the best of both worlds in that they have a scale appearance with simplified assembly. Fully scale, operating, sequencing doors could have been featured on this model, but would require above average building skills and detract from the every day flying utility of this model.

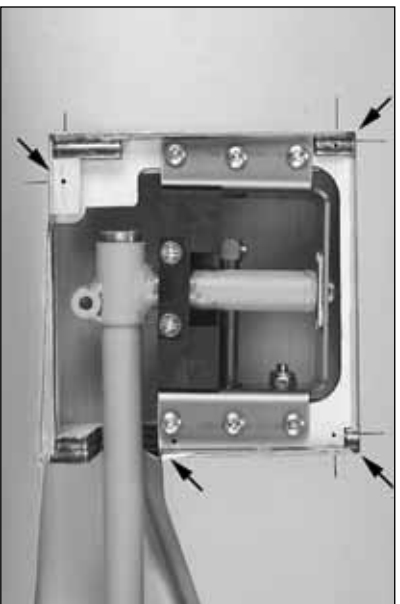

- R1. Mark, but do not drill, the locations of the four screws where shown in the photo that will be used for mounting the landing gear covers (the locations are indicated by the arrows in the photo). Use a fine-point felt-tip pen to draw reference marks on the wing, noting the locations of the screws.

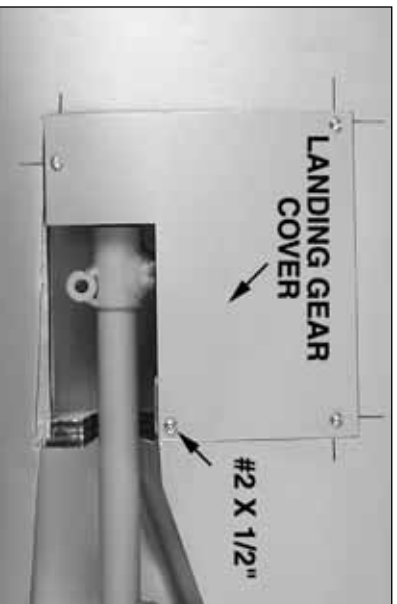

- R2. Install the 1/16" [1.6mm] plywood **landing gear cover**. Drill 1/16" [1.6mm] holes through the cover into the wing where the marks would cross. Remove the cover. Enlarge the holes **in the cover only** with a 3/32" [2.4mm] drill. Mount the cover with three #2 x 3/8" [9.5mm] screws and one #2 x 1/2" [13mm] screw.

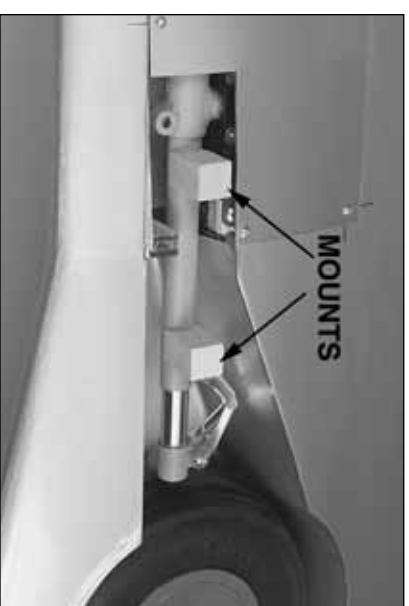

- R3. Place two hardwood **wheel cover mounts** on the strut. Mark the angle of the wing onto the mounts. **Note:** Only two mounts per wing half are required (but extras are provided in case you accidentally cut one too short or at the wrong angle).

- R4. Cut or sand the mounts at the angles you just marked.

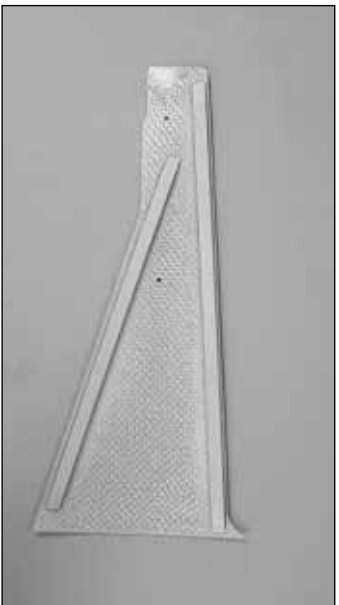

- R5. Use coarse sandpaper to thoroughly roughen the inside of the fiberglass wheel cover where the braces will go. Cut two **braces** from a 3/32" x 1/4" x 19-1/2" [2 x 6 x 500mm] hardwood stick to the length shown in the photo. Use medium CA to glue the braces into position. The braces should be inset 1/16" from the edges of the wheel cover.



- R6. Reposition the mounts on the strut. Place the fiberglass **wheel cover** on the mounts. The wheel cover should be even with the bottom of the wing. If necessary, make adjustments to the angle cut on the mounts until the wheel cover fits. If you end up cutting the mounts too short, try again with the extras provided.

- R7. The same way you drew the reference marks for drilling the holes in the hatch, mark and drill the holes in the wheel cover and the wheel cover mounts.

- R8. Mount the wheel cover to the mounts with two #2 x 3/8" [9.5mm] screws and #2 washers.



- R9. Use a 1/2" [15mm] strip of coarse sandpaper to remove the paint and roughen the struts where the mounts go.



- R10. With the wheel covers still attached to the wheel cover mounts, glue the mounts to the struts with 30-minute epoxy. Use masking tape with pieces of R/C foam underneath to hold the mounts to the struts and to hold the wheel covers in position.

- R11. After the epoxy from the previous step has fully hardened, remove the tape and extend the gear by hand. Make certain that the gear can operate freely and that there is no interference between the wheel cover and the wing. If necessary, trim the wheel cover for a good fit, and/or adjust the height and angle of the wheel cover by gluing thin balsa "shims" to the top of the wheel cover mounts.

- R12. Use one of your paper towel squares dampened with denatured alcohol to wipe the reference drawn on the bottom of the wing. Remove the wheel cover. Add a few drops of thin CA to the holes in the wheel cover mounts. Remount the wheel covers.

- R13. Return to step one and repeat the procedure to mount the hatch and wheel cover to the other gear.

Install the air lines

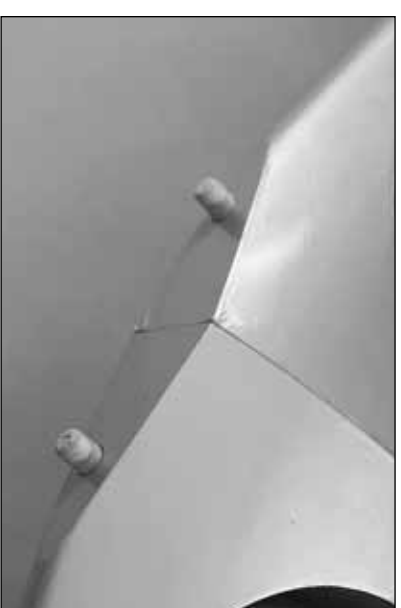

- R1. Before installing the air lines, cut the covering from the hole in the front of both wing halves for the 3/8" [10mm] **wing dowels**. Glue the dowels in with 30-minute epoxy. (The wings in the photo are joined, but your wings should not yet be joined.)

Now to the air lines (start with the left wing)...

- R2. Remove the retract hatch and the retract from the left wing. Add a few drops of thin CA to the screw holes.



- R3. Cut the covering from the holes in the top of the wing for the servo wires and the air line tubing.

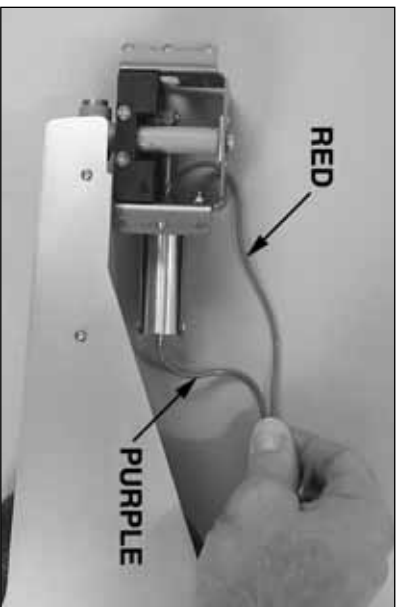

- R4. Cut a 21" [530mm] piece of red air line tubing and a 16" [400mm] piece of purple air line tubing from the tubing included with the Robart Air Control Kit (not included). Connect the red line to the outer fitting on the air cylinder and connect the purple line to the inner fitting (the one directly on the end) on the air cylinder.

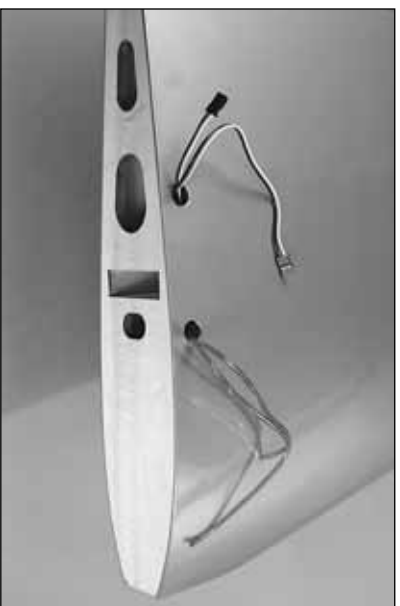

- R6. Guide the air lines out the front hole in the top of the wing and guide the servo wires out the other hole.
- R7. Mount the retract in the wing. Use a small screwdriver to move the end of the pushrod coming from the air cylinder in the retracted (up) position so the gear doesn't flop around while joining the wings. Install the hatch.

- R8. Hook up the air lines in the right wing panel the same way.

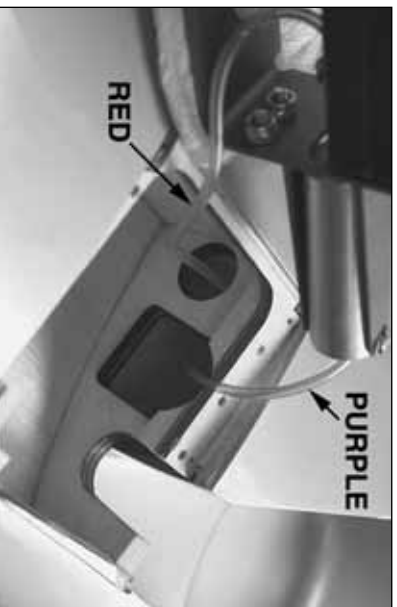

- R5. Use a piece of music wire with a hook bent on the end or something similar to pull the air lines through the wing. Note that the purple line goes through the same hole that the air cylinder fits through, and the red line goes through the round hole behind it.

Join the wing

Note: Keep the retracts (if installed) in the retracted (up) position so they do not extend and retract as you handle the wing.



Because the angle of wing joiner and the angle of the ribs on the end of the wing panels is factory-set, checking the dihedral, as would be done on a built-up kit, is not necessary. However, for those who insist on checking the dihedral anyway, this may be done by test fitting the wings together with the wing joiner. Tightly tape the wing halves together. The joining ribs on the end of both panels should fit well with no gap. If the wing halves do not fit well, remove any glue blobs or other obstructions that may be interfering. Once the joining ribs of the two wing halves fit well, lay the wing upside-down on your workbench. Measure the distance between the top of the wing and the workbench at the leading edge. Also measure the distance from the top of the wing and the workbench at the trailing edge. The sum of these two distances should be 5-3/16" [130mm] plus or minus 1/2" [13mm].

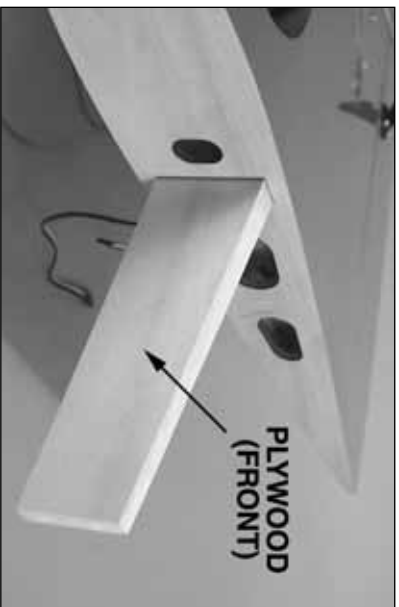

- ❑ 1. Test fit the **wing joiner** in one, then the other wing half. The plywood side goes forward. Test join the wings with the joiner. Make any necessary adjustments so the wings fit together well.



- ❑ 2. Gather everything required for gluing the wings together including 30-minute epoxy, mixing sticks, epoxy brushes, a 12" [300mm] piece of wire or a small dowel (for spreading epoxy), small paper towel squares, denatured alcohol (for epoxy clean up), masking tape, #64 rubber bands and mixing cups.

Note: When joining critical components such as the wing, it is imperative to coat **all joining parts** with epoxy. In other words, don't coat only one of the contacting end ribs. Coat the end ribs of **both** wing panels. Similarly, don't just coat the joiner. Also coat the insides of the wing where the joiners go.

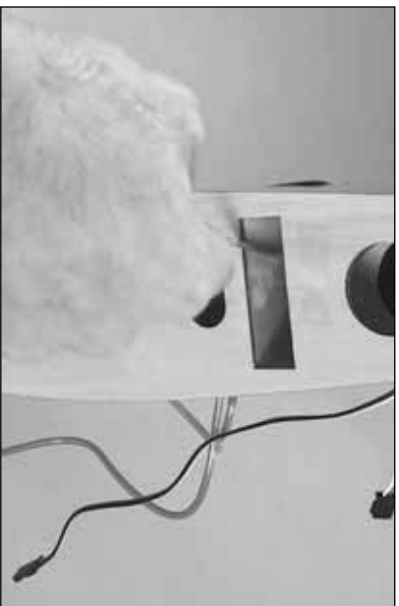

- ❑ 3. Mix up 2 oz. of 30-minute epoxy. **Working quickly**, pour a generous amount into one wing half where the joiner goes. Use your wire or dowel to **thoroughly** distribute the epoxy, coating all surfaces inside the wing. Coat the end of the wing and the half of the joiner that goes in the wing with the epoxy, then insert the joiner. Proceed **immediately** to the next step.

- ❑ 4. Coat the other side of the joiner and the inside of the other wing the same way. Join the wings, then stand the wing on-end with one of the tips resting on the floor (use a piece of R/C foam or something similar to cushion and stabilize the wing tip so it won't slide around).

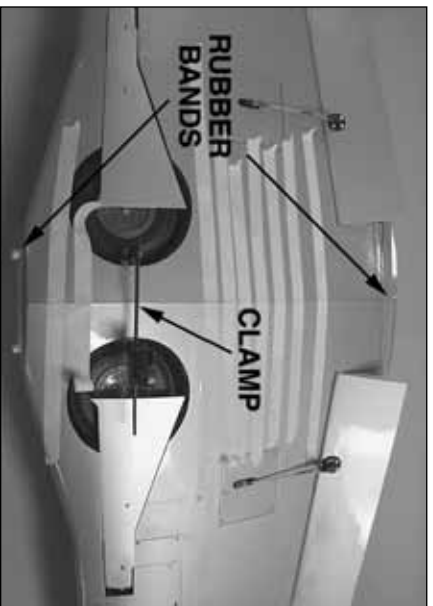

- ❑ 5. With the wing resting on end, use paper towel squares to wipe up excess epoxy as it squeezes out. Wrap #64 rubber bands around the trailing edges of the

wing inboard of the flaps and around the wing dowels. A clamp could be used at the wheel wells also. Add several strips of masking tape to **tightly** hold the wings together as you continue to wipe away excess epoxy as it squeezes out. Be certain the leading and trailing edges of the wing **accurately** align. Do not disturb the wing until the epoxy has fully hardened.

Perform step R6 only if you have installed retracts.

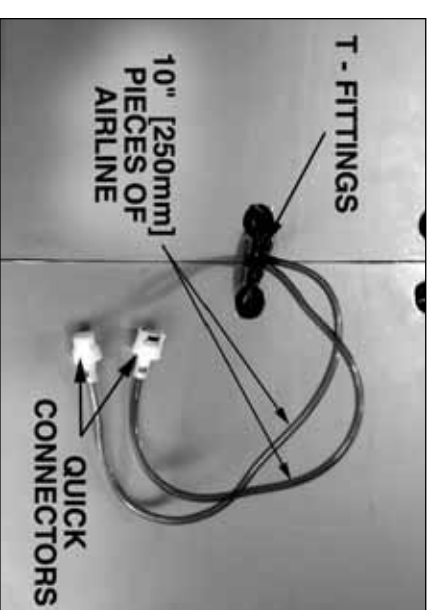

- ❑ R6. Join the matching air lines from each wing half with a couple of T-fittings that came with the air control kit. Cut two 10" [250mm] pieces of air line (also from the air control kit) and fit each line to the "T" fittings. Connect one quick-connector with an O-ring to one of the lines and one quick connector **without** an O-ring to the other line. This will prevent improper connection to the quick-connectors on the air valve when mounting the wing to the fuselage.

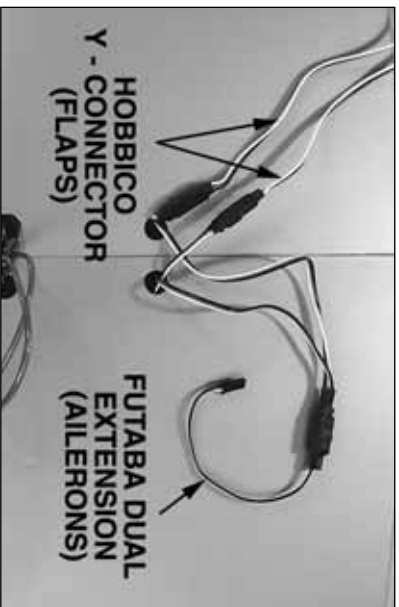

□ 7. Since the aileron servo wires already have extensions on them, they only require a short Y-connector such as the Futaba® dual extension cord (FUTM4130). Longer wires are needed for the flap servos, so a Hobbico® Y-connector (HCAM2751) was used there. Secure the connections with a small piece of heat shrink tubing included with this kit.

□ 8. Cut the covering from the holes in the top and bottom of the wing for the nylon wing bolts.

The radiator air scoop and wing fairing will be attached later.

If you've installed retracts, proceed to "**ASSEMBLE THE FUSELAGE**" on page 19.

Install the fixed landing gear

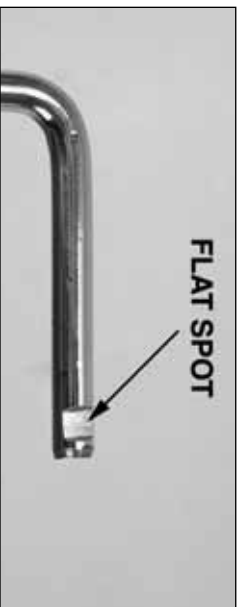

□ F1. Use a rotary tool with a cutoff wheel or a metal file to grind a flat spot near the end of both prebent **main landing gear wires** for the set screw in the outer wheel collar that holds the wheels on.



□ F2. The same as the covering was cut from the aileron hatches, cut the covering from the landing gear openings 1/4" [5mm] inside the edges all the way around the openings. Use a trim iron to iron down the covering.

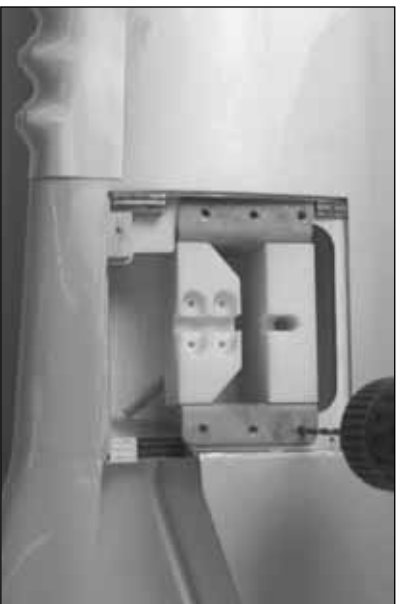

□ F3. Place both **fixed landing gear mounts** on the landing gear rails. The mounts are the same, but the part with the straps goes toward the leading edge of the wing. Using the holes in the mounts as a guide, drill six 7/64" [2.8mm] (or 1/8" [3.2mm]) holes into the rails.

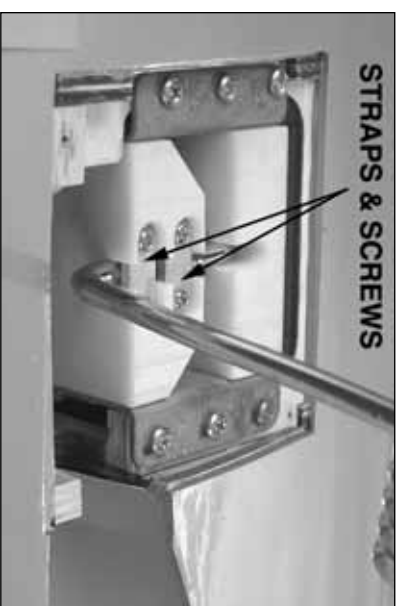

□ F4. Mount each main landing gear wire in the landing gear mount with two **metal straps** and four 3 x 10mm screws. Fasten the landing gear mounts to the rails with six #6 x 1/2" [13mm] screws.

□ F5. Mount the wheels to the landing gear with a wheel collar on both sides of both wheels. Use a small drop of thread locking compound on all the set screws and make sure the set screw in the outer wheel collars that hold on the wheels is keyed into the flat spots. Use the included 1.5mm wrench to tighten the set screws.



□ F6. Refer to steps R1 and R2 on page 14 to fit and install the plywood **landing gear covers**.

The radiator air scoop and wing fairing will be attached later.

ASSEMBLE THE FUSELAGE

Hinge the elevators and rudder

NOTES ABOUT CA HINGES

This kit is supplied with CA hinge material consisting of a 3-layer lamination of Mylar and polyester specially made for hinging model airplanes. When properly installed, this type of CA hinge provides the best combination of strength, durability and easy installation. Your giant P-51 and other giant warbirds like it have been thoroughly tested with these hinges, but it is essential to install them correctly. Follow the hinging instructions in this manual for the best result. The techniques shown have been developed to ensure thorough and secure gluing.

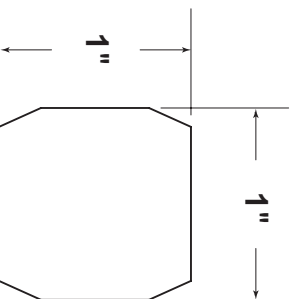

- 1. Cut twelve 1" x 1" [25 x 25mm] CA hinges from the supplied 2" x 9" [50 x 230mm] CA hinge strip. Cut off the corners so the hinges go in easier.

Note: The following three steps describe how to prepare the hinge slots for gluing in the CA hinges. This procedure may appear to be "more involved" than one would prefer for an ARF, but you will be rewarded with close, clean hinge gaps and free-moving, **securely** hinged surfaces.

LOOSEN THE HINGE SLOTS IF NECESSARY



- 2. Test fit one of the elevators to the stab with four hinges. If the hinge slots are too tight, they can be "loosened" by inserting a hobby knife and moving it from side-to-side. Note that it's the back side of the blade that does the work.

MAKE A SMALL SLIT (BOTH SIDES OF HINGE)

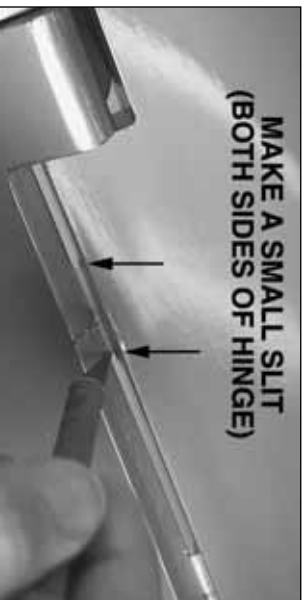

- 3. Make a small slit in the elevator **and** stab on both sides of all four hinges. These small slits will indicate the ends of the hinge slots.

SLITS

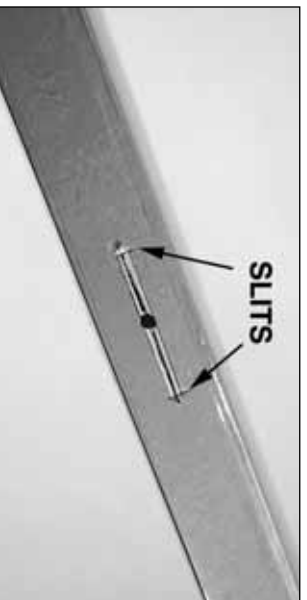

- 4. Remove the elevator. Cut a small strip of covering from each hinge slot in the stab and elevator between the slits. Drill 3/32" [2.4mm] holes, 1/2" [15mm] deep in the middle of all the hinge slots. A Moto-Tool with a cutting bit works well for this.

These "tunnels" will allow the CA to fully penetrate the hinge slots when it's time for permanently joining the elevators to the stab later on.

- 5. Prepare the rest of the hinges and the hinge slots in the stab and the other elevator and the rudder and fin the same way. **Do not** glue in the hinges until instructed to do so.

Glue in the stabilizer



Before proceeding, a building stand is required for working on the fuselage. In the R&D shop we prefer the Robart® Super Stand II (ROBP1402).



- 1. The same as you did the wing, use a covering iron to remove any wrinkles in the fuselage, stab and elevators. Remember to press down over sheeted areas (except where the wood bows inward). **Hint:** Use a pin to poke four or five holes beside each rib in the top and bottom of both elevators to allow air to escape while shrinking the covering.



HOW TO CUT COVERING FROM Balsa

To avoid cutting into the balsa, use a soldering iron instead of a hobby knife to cut the covering. The tip of the soldering iron doesn't have to be sharp, but a fine tip does work best. Allow the iron to heat fully. Use a straightedge to guide the soldering iron at a rate that will just melt the covering and not burn into the wood. The hotter the soldering iron, the faster it must be moved to melt a fine cut.

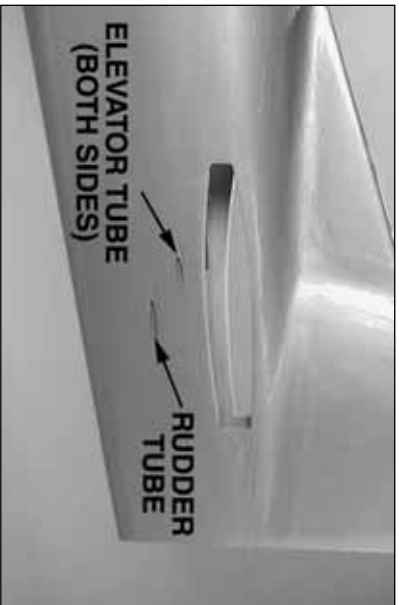

- ❑ 2. Cut the covering from the openings in both sides of the fuselage for the stabilizer. Also cut the covering from the elevator pushrod tubes on both sides of the fuselage and from the rudder tube on the left side of the fuselage.

- ❑ 3. Slide the stabilizer into the fuselage. Center the trailing edge of the stab in the fuselage by taking accurate measurements along the trailing edge.



- ❑ 4. Insert a pin through the top of the fuselage over the middle stringer at the firewall. Tie a loop in one end of a 60" [1.5m] piece of non-elastic line such as monofilament or Kevlar line (K+SR4575). Slip the loop in the string over the T-pin.

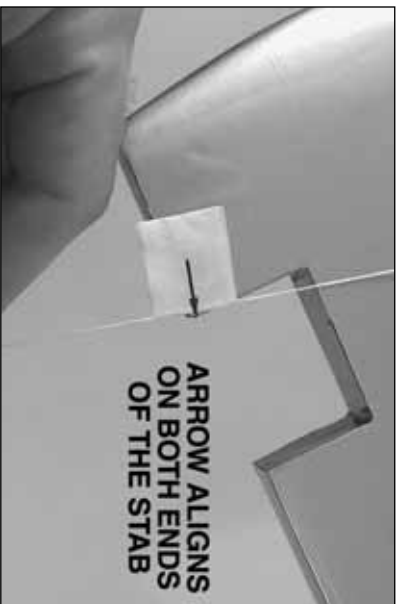

- ❑ 5. Fold a piece of masking tape over the string near the other end and draw an arrow on it. Slide the tape along the string and align the arrow with one end of the stab as shown in the photo. Swing the string over to the other end of the stab and hold it in the same position. Keeping the trailing edge of the stab **centered** from side-to-side, move the stab tips forward or back as necessary until the arrow aligns with both ends of the stab.



- ❑ 6. Use a fine-point felt-tip pen such as a Top Fite® Panel Line Pen (TOPQ2510) to mark the outline of the fuselage on the top and bottom of the stab.

- ❑ 7. Remove the stab from the fuselage. Use a **sharp, new #11** hobby blade or use the following **Hot Tip** to cut the covering from the stab along the lines. Use care to cut **only** into the covering and **not** into the wood. Cutting into the balsa will weaken the structure.



- ❑ 8. Peel the covering from the top and bottom of the center of the stab. Remove any ink from the stab and fuse with a paper towel square dampened with denatured alcohol. Re-seal the ends of the covering to the stab where it may have lifted while peeling off the middle.

One more alignment procedure before gluing the stab into the fuselage...

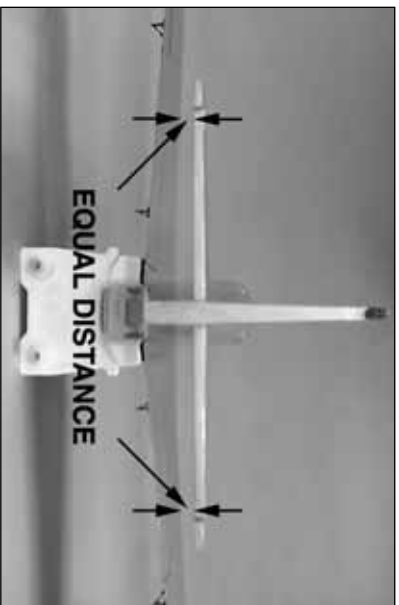

- ❑ 9. Bolt the wing to the fuselage with two 1/4-20 x 2" [50mm] nylon wing bolts. Center the stab in the fuselage. Stand approximately ten feet behind the model and view the stab and wing. If the stab and wing align with each other, proceed to the next step. If the stab and wing do not align, but are close, place a small weight on the "high side" of the stab to see if you can bring it into alignment. If weight is not enough, remove the stab from the fuselage and lightly sand the slots in the fuselage as necessary to align the stab with the wing. Reinsert the stab and check the alignment.



- ❑ 10. When ready to permanently glue the stab into the fuselage, wrap one side of the stab with a plastic bag or wax paper. This will protect the stab from epoxy when sliding it into the fuse.

- ❑ 11. **Thoroughly** coat the slot in the fuselage where the stab fits and the top and bottom of the stab where it joins the fuselage with 30-minute epoxy. Slide the stab into position. Remove the protective plastic wrapped around the stab in the previous step. Wipe off excess epoxy. Recheck the stab alignment the same as was done in the previous steps. Do not disturb the fuse until the epoxy has fully hardened.



- ❑ 12. Stick a T-pin through the middle of four hinges to keep them centered. After the epoxy on the stab has hardened, join the elevators to the stab with the hinges and remove the T-pins. Make a small gap between the stab and elevators—just enough to see light through or to slip a piece of paper through. Allowing enough time between drops to allow the CA to soak in, add six to eight drops of thin CA to **both sides** of all the hinges. **Hint:** Use a CA applicator tip so the CA can be applied directly to the hinges.

- ❑ 13. Join the rudder to the fin with the hinges and glue them in the same way.

Install the cockpit

Installation of the included semi-scale cockpit kit is optional. If you prefer not to install the complete cockpit, all that has to be done is to paint the existing balsa cockpit area and add the instrument panel decal. Should you decide to install the cockpit, keep in mind that although this model is an ARF, the included cockpit kit is a starting platform. Should you wish to add more detail, study photos of a full-size P-51 cockpit, then decide how to proceed. Many of the mechanisms can be added or enhanced simply with a fine paint brush and a selection of plastic model paint. Whatever pilot you decide to use should be test fit before gluing any of the cockpit parts into position in case any modifications are required.

Refer to this photo while working on the cockpit.

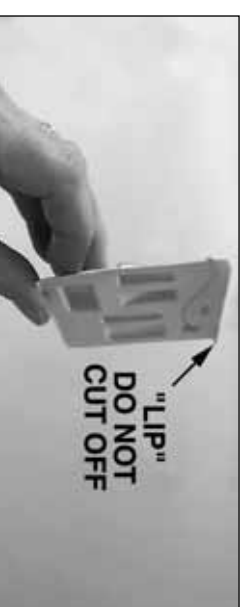
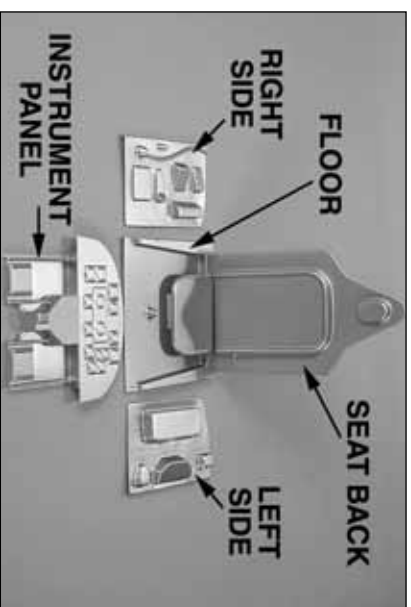

- ❑ 1. Use small scissors or curved-tip scissors (Such as Kyosho® or Great Planes) to cut out the cockpit **sides**. Do not cut the **lip** from top. Trim the aft edge (the edge with the angle) of both sides so they will fit between the formers in the cockpit.

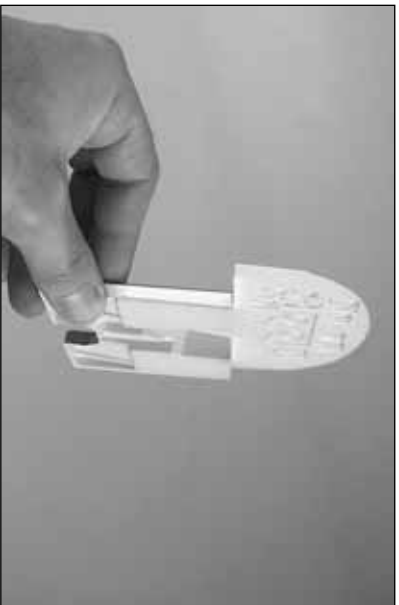

- ❑ 2. Cut out the **instrument panel**. There is no lip around the top. Trim the sides as necessary to fit in the fuselage.

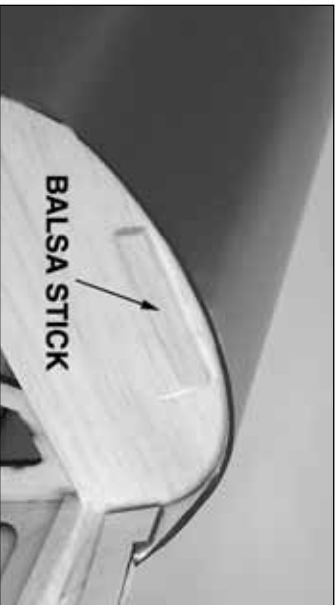

- ❑ 3. Glue the 1/8" x 1/4" x 2" [3 x 6 x 50mm] balsa stick to the balsa instrument panel in the fuselage. Temporarily fit the cockpit sides and the instrument panel into position.



- ❑ 4. Use small scissors or curved-tip scissors to rough-cut out the **canopy**. The best way is to do it in three steps—each time getting closer to the finished outline. First, cut away the biggest pieces. Then cut closer, but no closer than 1/8" [3mm] from the final cut. Finally, cut to the final shape all the way around, then true the edges by sanding.

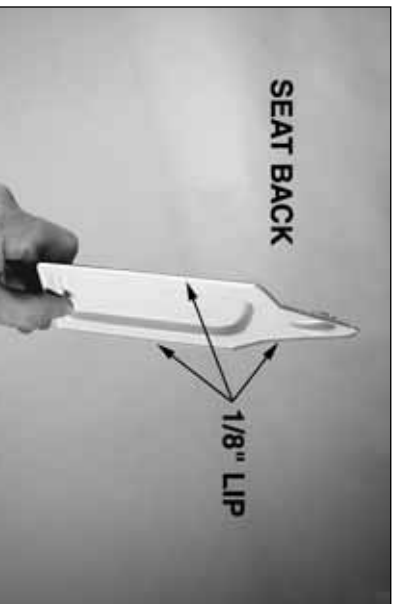
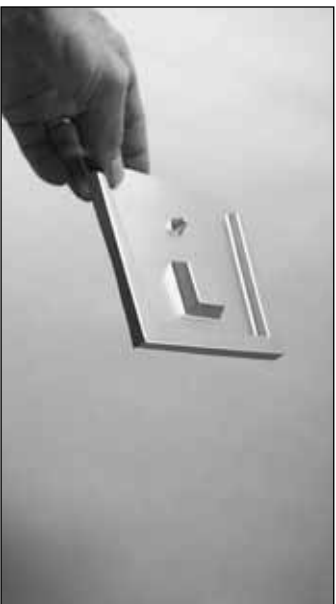

- ❑ 5. Cut out the **cockpit floor** to fit between the formers. Cut out the **seat back**, leaving a 1/8" [3mm] lip all the way around. From inside the fuselage, raise the floor up to the cockpit sides. Holding the floor in position, lower the seat back into the cockpit. Temporarily place the canopy on the fuselage. Make certain there is approximately 3/16" [5mm] clearance between the top of the seat back and the top of the canopy. Trim the seat back if necessary.

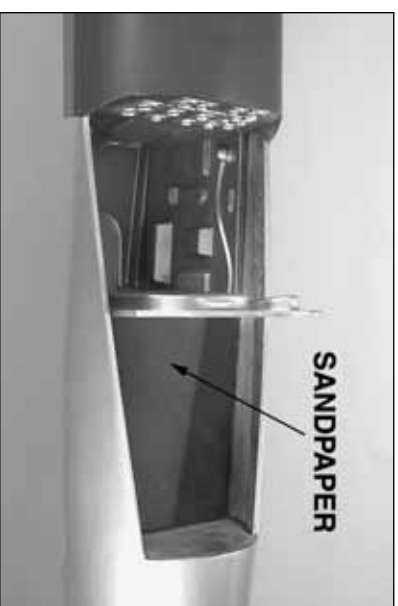

- ❑ 6. Now that you understand how it all fits, sand the edges of all the cockpit parts straight and true. Add any additional details you prefer, then use medium CA to securely glue in the cockpit parts.

- ❑ 7. Add any other final details to the cockpit you prefer. On our model we added 600-grit sandpaper to the cockpit floor aft of the seat.

If installing fixed landing gear, skip to "Mount the fixed tail gear" on page 26.

Mount the tail gear doors



- ❑ R1. Cut the covering from the tail gear opening in the bottom of the fuselage.



- ❑ R2. Make two **large** and two **small rubber band hooks** by gluing together the 1/16" [1.6mm] plywood pieces as shown.

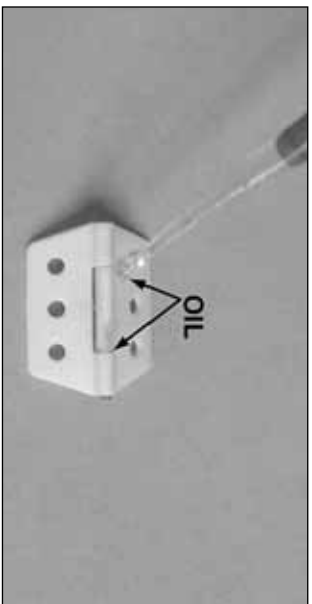
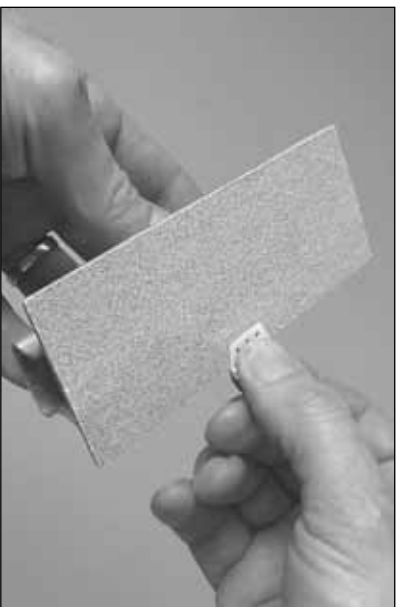

- ❑ R3. Use medium-grit sandpaper to roughen one side of all four nylon **pinned hinges** so glue will adhere. **Carefully** oil the hinge pin area with a **small** drop of household oil or a **small** dab of petroleum jelly.

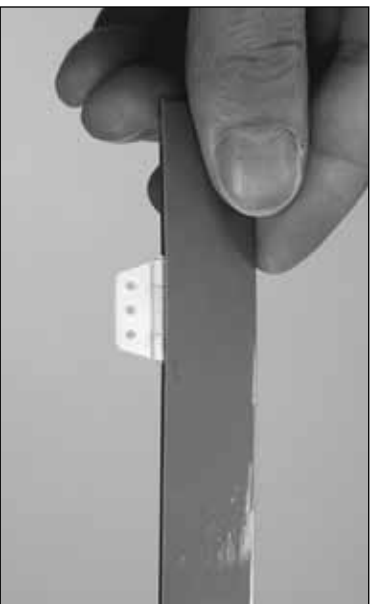
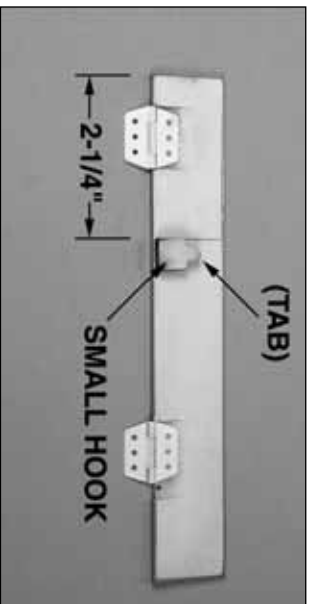

- ❑ R4. Use medium CA to glue two of the hinges and one of the **small** rubber band hooks to the **left** door as shown. The hook should be 2" [50mm] from the front of the door and the tab on the hook should be raised from the surface so a rubber band can be hooked around it. Also note that the pin portion of the hinges is on the outer edge of the door as shown in the close up photo.

- ❑ R5. Prepare the other tail gear door the same way.

- ❑ R6. Move the hinges back and fourth several times. If they are difficult to move, use a hobby knife to pick out any CA that may have gotten into the pin.

- ❑ R7. Glue the large rubber band hooks to the triangular balsa stick inside the door openings where they will align with the small hooks on the doors. Photos in the following steps show the hooks.

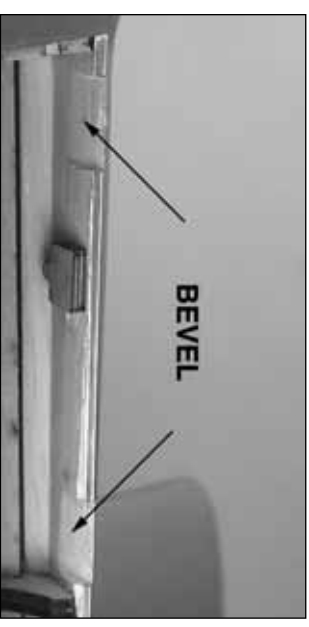

- ❑ R8. Holding the left door up to the wheel opening, mark the locations of the hinges on the edge of the opening. Cut 1/16" [2mm] notches at the marks and bevel the tri-stock so the hinge pins will be even with the bottom of the fuselage. Fit the right door the same way.

- ❑ R9. Test fit both doors in the opening. Make certain they will not interfere with each other when permanently glued into position. Make adjustments where necessary.

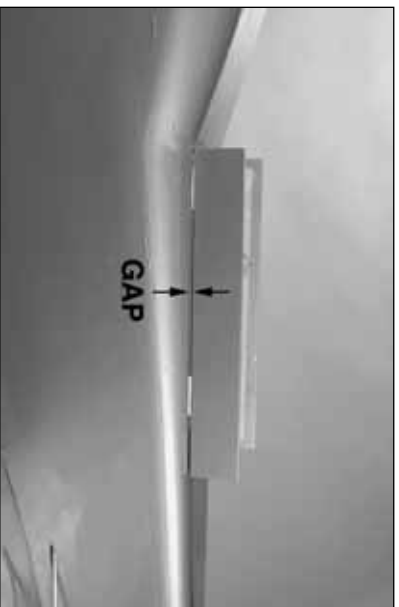

- ❑ R10. One at a time, glue the hinges on the doors to the fuselage. There must be a 1/32" to 1/16" [1 to 2mm] gap between the top of the doors and the bottom of the fuselage.

Mount the retractable tail gear

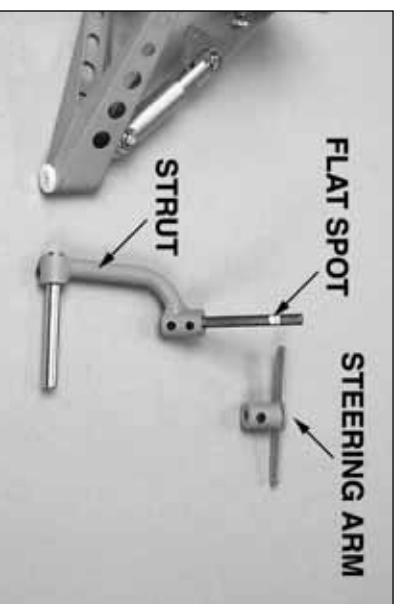

- ❑ R1. Remove the **steering arm** from the Robart #160LWC retractable tail gear assembly (not included). File a **flat spot** near the top of the shaft for the set screw in the steering arm to lock onto. Mount the steering arm to the shaft with a drop of threadlocker and the set screw.

- ❑ R2. File another flat spot near the bottom of the shaft for one of the set screws in the **strut**. Tighten both set screws with a drop of threadlocker on each. Be certain the steering arm and the axle in the strut remain parallel with each other. Make adjustments to the flat spots if necessary.

- ❑ R3. If necessary, enlarge the hole in a 1-3/4" [45mm] tail wheel (not included) with a #9 [5.0mm] drill. Cut the axle included with the Robart retractable tail gear to the correct length, then file a flat spot on it and mount it to the assembly.

- ❑ R4. Fit a 0-80 ball link ball in the middle hole in both sides of the steering arm as shown in the photo at step 8. Secure each with a drop of threadlocker and an 0-80 nut.

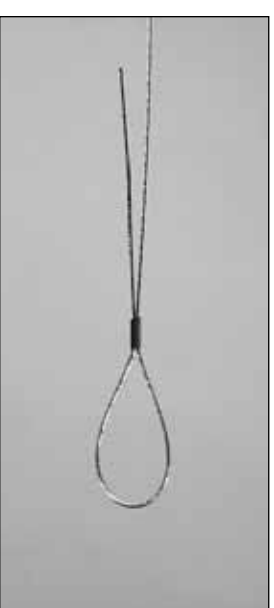

- ❑ 5. Use wire cutters to cut the supplied **braided cable** into two equal lengths. Slide a small **copper tube** (called a swage) over one end of one of the cables, then guide the end of the cable back through.



- ❑ 6. Guide the cable the other way back through the swage.



- ❑ 7. Use pliers to pull the short end of the cable until the small loop doubles-over at the end of the swage—but don't pull too hard or you'll pull the cable back through.

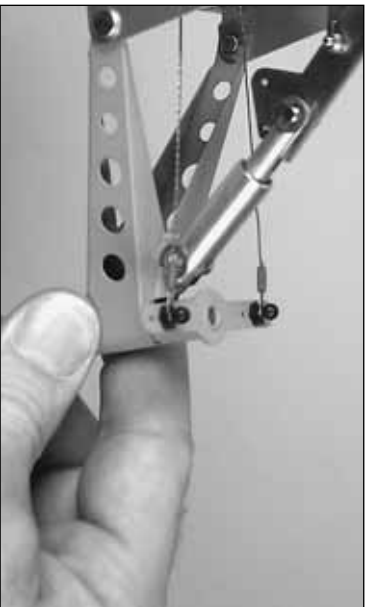

- ❑ 8. Snip off the short end of the wire at the swage. Slip the loop over one of the ball link balls on the steering arm. Tighten the loop until it is small enough to remain **secure** on the ball, yet may still be pried off. Squeeze the swage with pliers. Connect the other cable to the other ball link ball the same way.



- ❑ R9. Mark the bent aluminum **tail gear door brackets** "R" and "L" as shown in the photo. (The dashed lines in the photo note the bends in the brackets which will help identify the right one from the left one.)

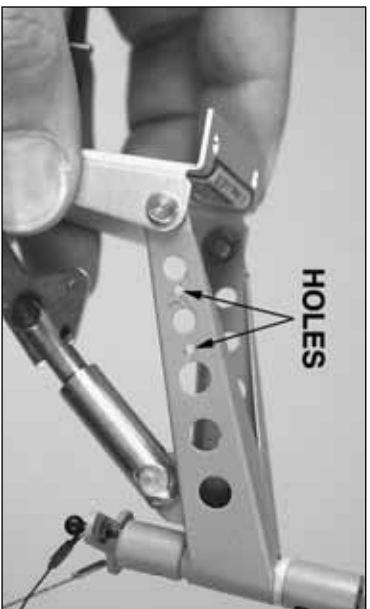

- ❑ R10. Mark, then drill two 3/32" [2.4mm] holes through the right side of the tail gear for mounting the right bracket. The metal is hard, so be patient while drilling. Use a metal punch if you have one to dimple the hole locations first.



- ❑ R11. Mount the right bracket with two 2-56 x 3/8" [9.5mm] screws, a drop of threadlocker and 2-56 nuts.

- ❑ R12. Mount the left bracket the same way.

- ❑ R13. Connect 40" [1m] of red air line to the **aft** fitting on the tail gear air cylinder and 40" [1m] of purple air line to the **forward** fitting on the air cylinder. There is not enough air line leftover from the main gear, so additional line will have to be purchased separately (Robart #169 Pressure Tubing).

- ❑ 14. Place the tail gear retract in the fuselage while simultaneously guiding the pull/pull cable through the gray plastic guide tubes and guiding the air lines up through the fuselage.

- ❑ 15. Drill four 3/32" [2.4mm] holes through the rails for mounting the tail gear. If your drill bit is not long enough to reach the rail nearest the top of the fuselage, use medium CA to temporarily glue a 3/32" [2.4mm] drill bit in a 1/8" [3.2mm] brass tube. After drilling the holes, the drill can be removed from the tube by heating.

- ❑ 16. Mount the tail gear with four #4 x 1/2" [13mm] screws.

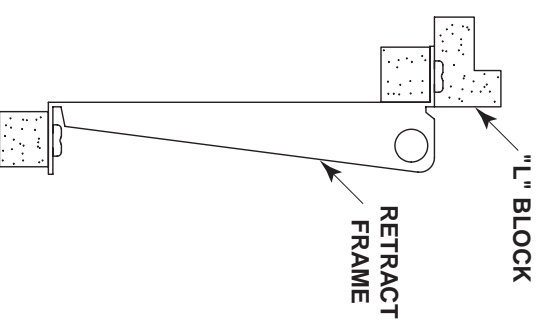

- ❑ R17. Glue the hardwood "L" block directly to the aluminum frame of the retract. Glue the 1/16" x 3/8"

x 1-9/16" [1 x 10 x 40mm] plywood **tail gear door** **step** to the inside of the sheeting on the bottom of the fuselage. These will keep the doors from closing too far. Hook two small rubber bands included with this kit onto both pair of rubber band hooks.

R18. Use the air pump that will be used to pressurize the air tank or a can of compressed air to retract and extend the tail gear a few times to make sure everything operates correctly. Make adjustments where required. Skip ahead to "Hook up the elevators and rudder" on this page.

Mount the fixed tail gear

F1. Cut the covering from the tail gear opening in the bottom of the fuselage.

Refer to this photo for the following three steps.

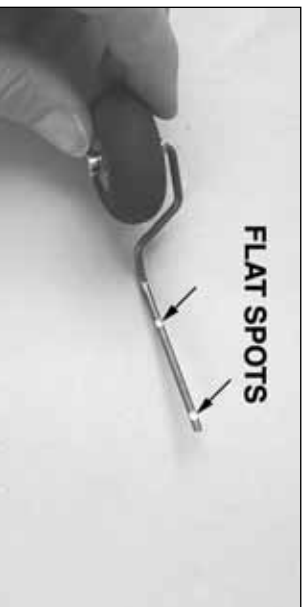
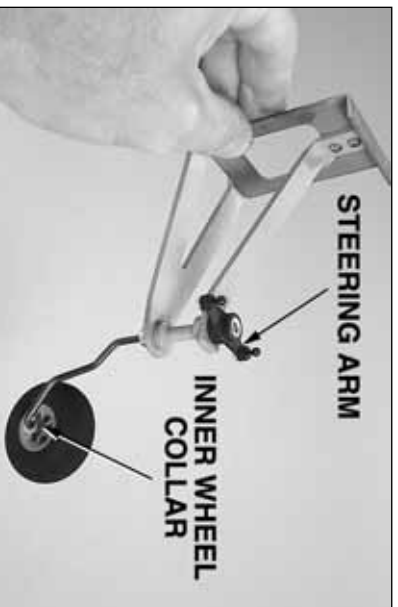

F2. File flat spots on the tail gear wire for the set screw in the outer wheel collar that holds on the wheel,

and for the set screws in the wheel collar **steering arm** that hold the tail gear wire in the tail gear mount. Mount the tail wheel with two wheel collars and set screws using a drop of thread locking compound.



F3. Enlarge the holes in the steering arm with a 5/64" [2mm] or 3/32" [2.4mm] drill bit. Mount a 2-56 ball link ball to each arm with a 2-56 nut and a drop of threadlocker.

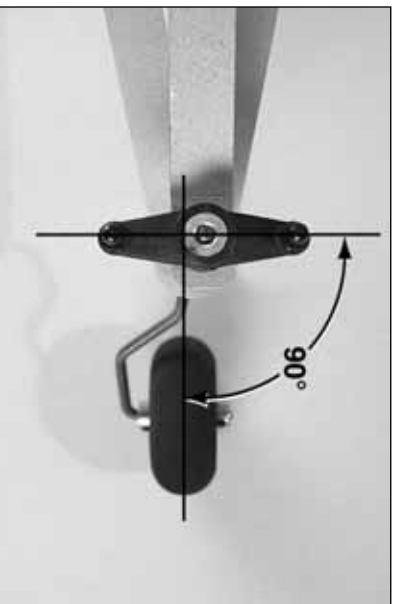

F4. Assemble the tail gear. Be certain to use thread locking compound on all the set screws. Also note that the steering arm should be perpendicular to the tail wheel.

Perform steps 5, 6, 7 & 8 and steps 14, 15 & 16 on pages 24 & 25 to connect the pull/pull cables to the steering arm and to mount the tail gear in the fuselage. When finished, proceed to "Hook up the elevators and rudder."

Hook up the elevators and rudder

Refer to this photo for the following three steps.



1. Cut 6" [150mm] from the unthreaded end of two 36" [910mm] wire pushrods. Connect the pushrods to the middle hole in two nylon control horns with a 4-40 nut, threaded clevis and a silicone retainer. Slide the pushrods into the elevator pushrod tubes in both sides of the fuselage.

2. Mount the control horns to the elevators the same way you mounted the control horns on the flaps and ailerons (by drilling 3/32" [2.4mm] holes and using #4 x 1/2" [13mm] screws—don't forget to harden the holes with thin CA after first installing, then removing the screws).

3. Prepare the rudder pushrod and mount the control horn the same way, only use #4 x 5/8" [16mm] screws instead of 1/2" [13mm] screws.



- ❑ 4. Glue together both 1/8" [3mm] plywood **aft servo trays**. Test fit the two elevator, one rudder and one tail wheel servo in the tray. Make any adjustments required so the servos fit.



- ❑ 5. Place the servo tray in the fuselage.

Refer to this photo while hooking up the servos.



- ❑ 6. Place all four servos in the servo tray. Make three one-arm servo arms and one two-arm servo

arm from the arms that came with your servos. Place the arms on the servos as shown in the photo.

- ❑ 7. The same as was done for the aileron and flap pushrods, mark the elevator and rudder pushrods where they are to be cut for soldering on the clevises. One at a time, unthread each pushrod from the clevis on the control horn, remove the pushrod from the fuselage, cut it to the correct length, then solder on the clevis. Reinstall the pushrod from the front, then connect them to the servo arms and control horns. Don't forget to use a silicone retainer on all the clevises and to install 4-40 nuts on the pushrods ahead of the thread-on clevises.



- ❑ 8. Connect the two clevises with the threaded, brass couplers and nuts on them to both ends of the tail steering servo arm. Put a small piece of tape on one of the pull/pull cables coming from the tail steering arm. Center the tail wheel and slide the tape along the cable to mark where it will be looped-over to go into the brass coupler.

- ❑ 9. Take the servo arm off the tail steering servo and disconnect the cable from the ball link on the steering arm. Pull the cable up through the guide tube. Use the tape as a reference for where to bend the cable to loop it through the brass coupler. Secure the cable to the coupler with a swage.

- ❑ 10. Guide the looped end of the cable back down through the guide tube and reconnect it to the ball link ball on the steering arm. Mark and connect the other cable to the brass coupler on the other side of the servo arm same way.

- ❑ 11. Mark the hole locations for the servo mounting screws on the servo tray. Remove the servo tray, then drill 1/16" [1.6mm] holes at the marks. Screw, then remove a screw in each hole. Add a few drops of thin CA and allow to harden.

- ❑ 12. Securely glue the servo tray in the fuselage with 30-minute epoxy. Mount the servos in the tray and hookup the pushrods.

We'll finish up the rest of the radio installation and mount the components for the air system after the engine has been mounted.

Mount the engine

The following instructions illustrate how to mount a U.S. Engines 41cc gas engine. A Great Planes Gasoline Engine Mount (GPMG2000—not included) and the parts included with this model will provide the correct alignment and spacing. If not using a U.S. Engines 41cc engine, use the appropriate hardware to mount your engine (or engine mount) centered on the horizontal and vertical alignment marks on the firewall. Note that the back of the spinner backplate should be 7-1/2" to 7-3/4" [190 to 200mm] from the firewall.



- ❑ 1. If using a U.S. Engines 41cc engine, use the **engine mount template** in the back of the manual to mark the engine mounting bolt locations on a Great

Planes Gasoline Engine Mount. Drill 17/64" [6.8mm] (or 9/32" [7.2mm]) holes at the marks. Cut off the bottom of the mount as indicated on the template. Mark the **top** and **front** of the mount as shown.

- ❑ 2. Remove the muffler and carburetor from the engine. This will facilitate mounting the engine and fitting the cowl.

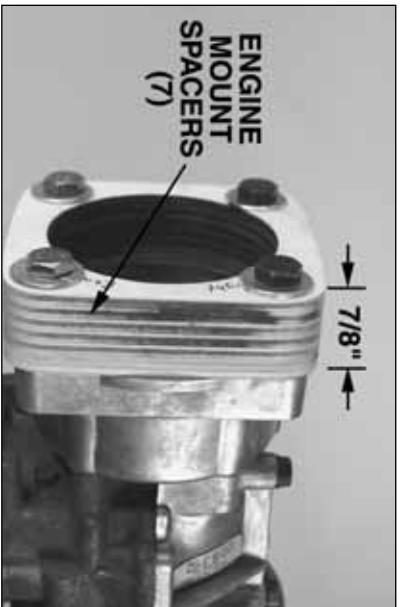

- ❑ 3. The U.S. Engines 41cc is to be spaced approximately 7/8" [22mm] **from the mount** (not from the firewall). If your U.S. Engine came with the 1/2" [13mm] black, plastic engine mount spacer, glue together **three 1/8" [3mm] plywood engine mount spacers**. If your U.S. Engine did **not** come with the black, plastic spacer, glue together **seven 1/8" [3mm] plywood engine mount spacers**. This is most easily done by lightly coating the spacers with 30-minute epoxy and using the bolts that came with the Great Planes Gasoline Engine Mount to bolt the spacers to the engine—do not over tighten the bolts, thus deforming the plywood. **Note:** The **straight** edge of the spacers goes on the right side of the fuselage.

- ❑ 4. After the epoxy on the engine mount spacer has hardened, remove it from the engine and sand the edges even and smooth.

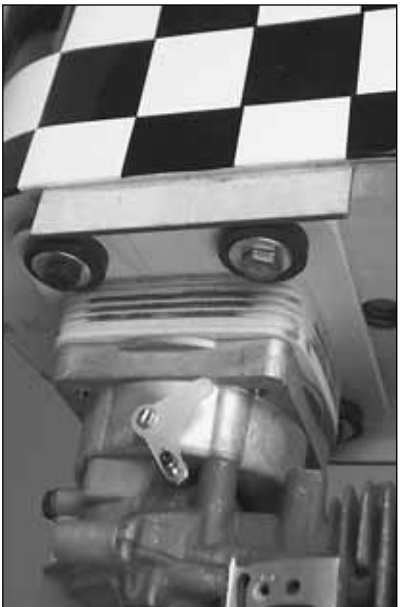

- ❑ 5. Use 1/4-20 x 1-1/2" [40mm] bolts and 1/4" [6.4mm] washers (not included) to mount the engine with the plywood spacers and the plastic spacer (if included with the engine) to the engine mount. Bolt the engine mount to the firewall using the rubber bushings, washers and bolts that came with it.

Mount the cowl

Refer to these photos for the following two steps.

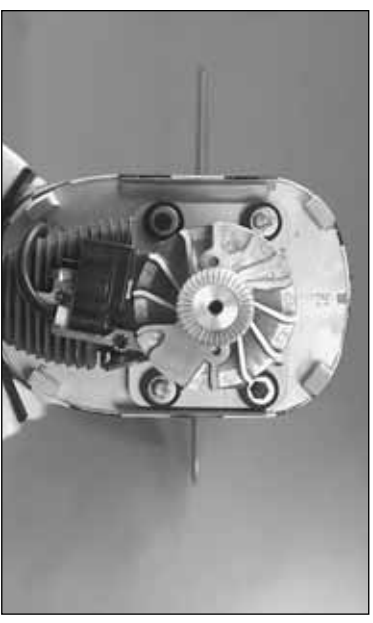

- ❑ 1. Use a hobby knife and sandpaper to shape four of the six supplied 1/2" x 13/16" x 13/16" [12 x 20 x 20mm] hardwood **cowl mounting blocks** to match the shape of the fuselage and the cowl.

- ❑ 2. **Thoroughly** roughen the firewall in the four locations where the cowl mounting blocks will go. Coat the end of the blocks and the firewall with 30-minute epoxy. Allow the epoxy to "tack up" so the blocks won't fall off, then place them on the firewall. Continue to monitor and reposition the blocks as necessary until they will stay in place. Allow the epoxy to fully harden.



- ❑ 3. After the epoxy from the previous step has hardened, drill two 1/8" [3.2mm] holes through the blocks and the firewall. Cut eight 1-1/4" [30mm] pieces from the 1/8" x 12" [3.2 x 300mm] hardwood dowel. Coat the dowels and the holes in the mounting blocks with 30-minute epoxy, then use a hammer to tap the dowels all the way in.

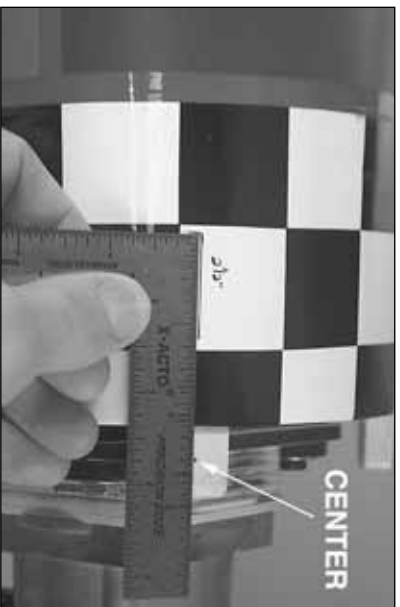

- 4. Mark the center of all four mounting blocks with a pen. Lay a small ruler on the fuselage with one edge over the mark. Use a felt-tip pen to draw a line directly on the fuselage along the ruler. Mark another line on the fuselage 2-1/2" [65mm] as shown from the center mark on the mounting block. When the cowl is in place the lines and measurements will pinpoint the center of the blocks under the cowl.



- 5. Mark the remaining three cowl mounting blocks and the fuselage the same way.
- 6. Slide the cowl over the engine onto the fuselage. Use a Dremel tool with a cutting bit to trim the cowl where necessary so you can get it to fit over the engine. At this stage the cowl shouldn't require much trimming since the carburetor and muffler have been removed.

- 7. If necessary, use a prop reamer or the appropriate-size drill to enlarge the hole in the prop for the crankshaft (or propeller bolt).

- 8. Temporarily mount the spinner backplate and propeller to the engine. Mount the spinner cone to the backplate with the 3mm screws.

- 9. Use tape or have an assistant hold the cowl in position. Be certain to provide clearance between the cowl and spinner—1/8" to 3/16" [3 to 5mm] should be adequate. Also be certain the checkers on the top of the cowl are centered on the checkers on the top of the fuselage.



- 10. Mark the cowl 2-1/2" [65mm] from the mark on the line indicating the center of one of the cowl mounting blocks. Drill a 3/32" [2.4mm] hole through the cowl into the mounting block inside.

- 12. Temporarily fasten the cowl to that mounting block by partially installing a #4 x 5/8" [16mm] screw. Drill the rest of the holes the same way.

- 13. After all four holes have been drilled, remove the cowl and enlarge the holes **in the cowl only** with a 1/8" [3.2mm] drill. Mount the cowl with the screws.

- 14. Remove the spinner, prop and cowl. Wipe the alignment marks from the fuselage using one of the small paper towel squares dampened with alcohol.

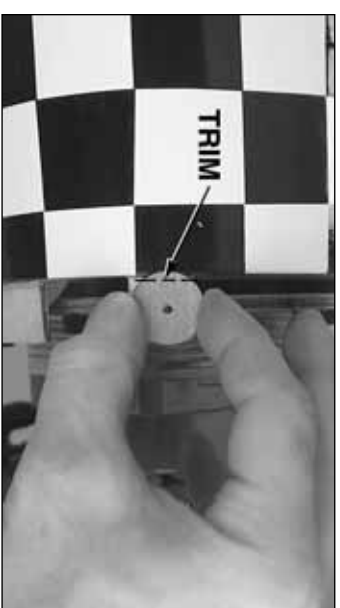

- 15. Drill a 1/8" [3.2mm] hole through four of the supplied 1/16" x 7/8" [1 x 22mm] round, plywood **cowl reinforcements**. Align the hole in one of the reinforcements over the hole in one of the cowl mounting blocks as shown in the photo. If necessary, trim the aft edge of the cowl reinforcement so it will not interfere with the fuselage when glued inside the cowl.

- 16. If necessary, trim the remaining three cowl reinforcements the same way.



- 17. Roughen the inside of the cowl around the screw holes. Add a dab of petroleum jelly or a drop of household oil to the threads of four 4-40 x 3/8" [9.5mm] screws and 4-40 nuts. Glue the cowl reinforcements to the inside of the cowl using the screws and nuts to hold them until the epoxy hardens.

- 18. After the epoxy has hardened, remove the screws. Redrill the holes with a 1/8" [3.2mm] drill, then mount the cowl with four #4 x 5/8" [16mm] screws, #4 flat washers and #4 lock washers. Mount the spinner and prop to see how it all looks.

Install the air tank

Refer to this photo while installing the air tank.



❑ R1. Glue together the two 1/8" x 3-3/8" [3 x 85mm] O.D. plywood **air tank mounting rings**. Glue the rings to the ring that's part of the instrument panel former.

❑ R2. There should be two pieces of air line remaining that are approximately 24" [610mm] long. Connect one of the pieces to the air tank. Slip the 1/8" [3mm] plywood **air tank former** around the air tank, then place the assembly in the fuselage. Use medium CA to permanently glue the air tank former to **F-3** as shown, or if you prefer to make the air tank removable, use #2 screws (not included) to hold the air tank former to **F-3**.

❑ R3. Use a few dabs of RTV silicone or epoxy to glue the air tank into position.

Install the fuel tank

Note: The included Great Planes 32 oz. [960cc] fuel tank is suitable for both gasoline and glow fuel.

Refer to this photo while preparing the fuel tank.



❑ 1. Assemble the fuel tank using the hardware and included fuel-pickup line that goes inside the tank. Be certain the clunk cannot contact the back of the tank. Otherwise, it may become stuck above the fuel level and discontinue fuel flow causing the engine to quit. **Note:** The fuel tank setup in the manual uses three lines. The line connected to the fuel pickup in the tank goes to the carburetor. The line connected to the fitting on the top of the tank is for fueling and defueling. The line connected to the middle fitting on the tank (which must be drilled out with a 5/64" [2mm] drill) is the vent line. A three-line setup eliminates the requirement for a fuel filler valve. If you prefer to use a filler valve, a two-line setup may be used.

❑ 2. Drill 3/32" [2.4mm] holes through the marks near the aft edge of the plywood **fuel tank floor**. Use two #64 rubber bands to hold the fuel tank to the fuel tank floor with a sheet of 1/4" or 1/2" [6 or 13mm] R/C foam in between.

❑ 3. Connect the external fuel lines to the tank—use silicone fuel line for glow engines and use neoprene fuel line for gasoline engines. Leave the lines extra long so that they can be guided through the firewall. The lines will be cut to the correct length later.

❑ 4. Drill holes through the firewall for the fuel lines. The size of the holes will depend on the size of the fuel line you are using. Be certain to drill the holes so that the lines will not interfere with the engine or engine mount and so they will not become kinked behind the firewall.



❑ 5. Fit the fuel tank with the fuel tank floor in the fuselage while guiding the fuel lines through the holes. Note that the **front** of the fuel tank keys into the **groove** between the balsa sticks on the back of the firewall.

❑ 6. While you still remember, write the name of each fuel line ("carb," "vent," "fueling,") on the firewall near the hole where the line comes out. This way you'll know where the lines go when it's time to connect them.

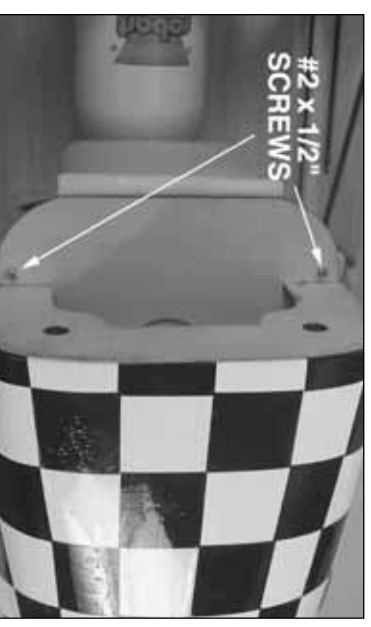

❑ 7. Using the holes near the aft end of the fuel tank floor as a guide, drill 1/16" [1.6mm] holes through the small hardwood blocks that support the rear of the floor. Fasten the floor to the blocks with two #2 x 1/2" [13mm] screws and #2 washers.

Hook up the throttle

Note: If using a spark ignition engine, be certain to maintain a **minimum distance** of 12" [300mm] between electronic parts of the radio system (servo, receiver, battery, etc.) and the engine. Also, never use a full-length, metallic pushrod to operate the throttle.

Refer to the following two photos while hooking up the throttle.

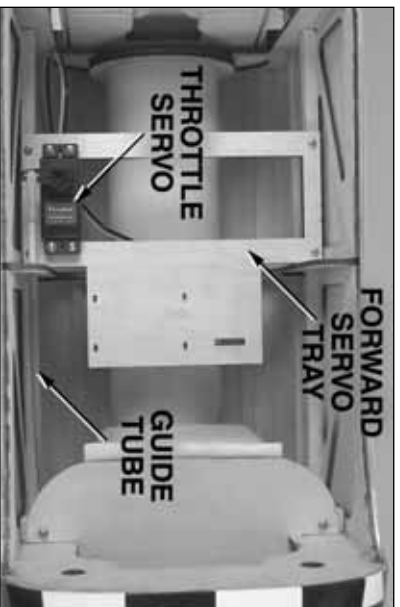

- ❑ 1. If using a U.S. Engines 41cc, move the ball link ball that was factory-mounted on the bellcrank to the middle hole. Connect a 0-80 ball link ball to the outer hole on the other end of the bellcrank with a drop of threadlocker and a 0-80 nut.
- ❑ 2. Mark the engine mount where the throttle pushrod should go through to connect to the bellcrank.



- ❑ 3. Remove the engine from the engine mount. Bolt the mount to the firewall without the engine. **Being certain not to drill into the fuel tank**, drill a 3/16" [4.8mm] hole through the engine mount and the firewall at the mark for the throttle pushrod. Enlarge the hole **in the engine mount only** with a 1/4" [6.4mm] drill.

- ❑ 4. Remount the engine to the engine mount.



- ❑ 5. Cut two 4-3/4" [120mm] **forward servo tray rails** from the 1/4" x 1/4" x 12" [6 x 6 x 300mm] hardwood stick. Securely glue the rails to the main side stringer as shown.

Refer to this photo while installing the forward servo tray.

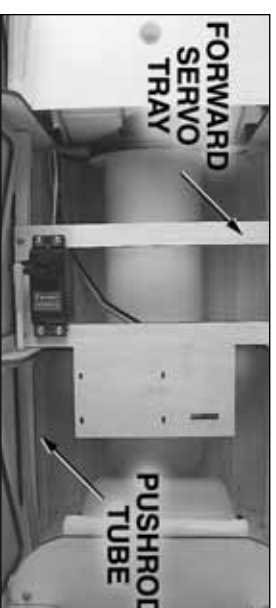

- ❑ 6. Glue together both plywood **forward servo trays**. Place the forward servo tray on the rails. Drill four 1/16" [1.6mm] holes through the servo tray and the rails for the mounting screws. Take out the servo tray and enlarge the holes **in the servo tray only** with a 3/32" [2.4mm] drill. Mount the tray to the rails with four #2 x 1/2" [13mm] screws.

- ❑ 7. Cut the 3/16" x 24" [4.8 x 610mm] gray pushrod guide tube to the correct length for the throttle. Use coarse sandpaper to roughen the tube so glue will adhere where it goes through the firewall and formers. Slide the guide tube into position.

- ❑ 8. Fit the throttle servo in the servo tray. Cut the white, plastic pushrod to the correct length so it can be connected to the throttle servo with a nylon clevis and to the bellcrank with a nylon ball link.

- ❑ 9. Thread a 2-56 x 1" [25mm] threaded rod into both ends of the throttle pushrod. Connect the nylon ball link to one end of the rod, then slide the rod into the guide tube from the front.

- ❑ 10. Connect the nylon clevis to the threaded rod on other end of the pushrod. Connect the clevis to the throttle servo arm with a silicone retainer. Use medium CA to glue the guide tube to the firewall and the formers.

- ❑ 11. Remove the forward servo tray. Add a few drops of thin CA to the holes in the servo tray rails and allow to harden. Mount the throttle servo to the tray as well. Remount the servo tray.

Hook up the air lines

Refer to this photo while hooking up the air lines.



- ❑ R1. Use epoxy to glue the plywood **air valve mount** to the forward servo tray. After the epoxy hardens, mount the air valve to the air valve mount.



- ❑ R2. Use the remaining air line and two **T-fittings** to connect the **fill port**, **check valve** and **pressure gauge** (optional) to the air tank. Also connect the **quick disconnects** to the air lines coming from the tail gear air lines via two **T-fittings**. The remaining, open end of these T-fittings will be connected to the air valve. Connect another line to the T-fitting between the fill port and the check valve. This line will be connected to the air valve. **Note:** Use the plywood **air line guides** to keep the air lines neat and tidy and away from other working components (such as servos, pushrods, etc.).

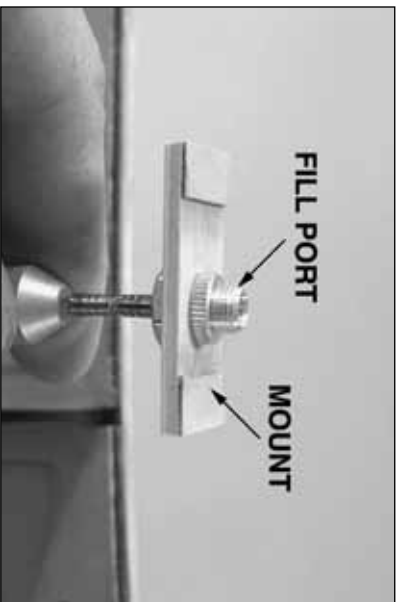

- ❑ R3. Mount the fill port and pressure gauge (if used) to the fuselage side. The fill port can be mounted flush to the outside of the fuselage via a mount made from plywood (not supplied).

- ❑ R4. Connect the air valve servo to the air valve using a 2-56 x 4" [100mm] pushrod and a nylon clevis. Connect the pushrod to the servo arm with a "Z" bend. Connect the remaining air lines to the air valve.

Mount the kill switch (for spark ignition engines only)

As stated in the IMAA Safety Code, all magneto spark ignition engines must have a manually operated, coil-grounding switch to stop the engine and prevent accidental starting. A .3 Amp slide switch, 16 gauge wire and two spade terminals were purchased at the local Radio Shack® for this purpose. These common components should also be available at any hardware or home improvement store.



- ❑ 1. Mount the switch in a location where it will be easily accessible from outside the model.



SOLDER THE WIRES WHERE SHOWN

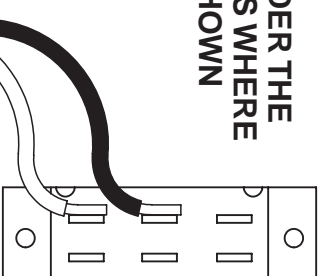

- ❑ 2. Determine the correct length of the wires knowing that they must not contact the muffer or engine. Cut the wires to the correct length, then solder the wires to the switch and spade terminals.

- ❑ 3. Connect the terminals to the engine, making certain the wires will not contact the engine or muffer.

Finish the engine compartment



- ❑ 1. Use a high-speed rotary tool with a carbide cutting bit to cut the hole in the cowl for the carburetor. For the U.S. Engines 41, this procedure is made easier if the muffler and venturi are removed. Slip the cowl into position, then, carefully viewing the cowl and the carburetor inside and out, mark the approximate location of the cutout. Remove the cowl. Cut inside the lines starting with a small hole. Fit the cowl, redraw the lines, then remove and cut the cowl again. Continue to “zero-in” on the correct size and shape of the cutout by fitting, marking and enlarging the cutout in small increments. Mount the venturi after the cowl has been fit over the carb. **Note:** The

venturi must be removed whenever the cowl requires removal or installation. During initial engine tuning and break-in it will be best to leave the cowl off the model until all adjustments have been made. When satisfied with the performance and reliability of the engine, the cowl can be installed.



- ❑ 2. Cut the fuel line that goes to the carburetor to the correct length, then hook up the fuel line. Drill two holes through one of the remaining 1/2" x 13/16" x 13/16" [12 x 20 x 20mm] hardwood blocks to accommodate the fuel lines. Trim the block to a smaller, finished shape, then use epoxy to glue the block to the bottom of the firewall. Guide the fueling line and the vent through the holes in the block.
- ❑ 3. Cut any other necessary holes in the cowl for the ignition switch, engine exhaust, fuel lines, etc.
- ❑ 4. If you haven't already done so, remove the engine and coat all bare wood parts (such as the engine mount, engine mount spacers, cowl mount blocks, etc.) with 30-minute epoxy or fuelproof paint. Allow to dry, then remount the engine.

MOUNT THE SCALE DETAILS

Radiator air scoop

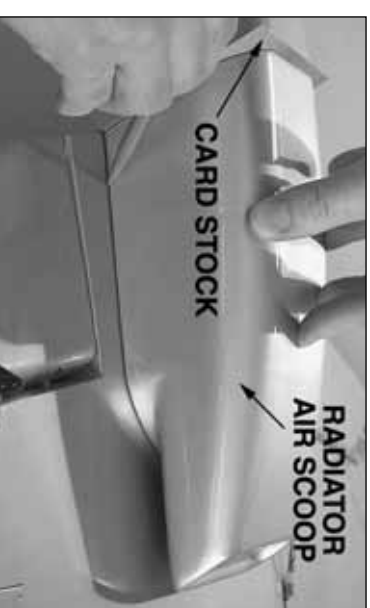

- ❑ 1. Mount the wing to the fuselage with the wing bolts. Place the fiberglass **radiator air scoop** on the wing. Place a piece of thin cardstock between the back of the air scoop and the fuselage. Use a fine-point felt-tip pen to mark the outline of the air scoop onto the bottom of the wing.

- ❑ 2. Carefully cut the covering 1/32" [1mm] inside the line. Be careful not to cut into the balsa. Peel the covering from the wing.

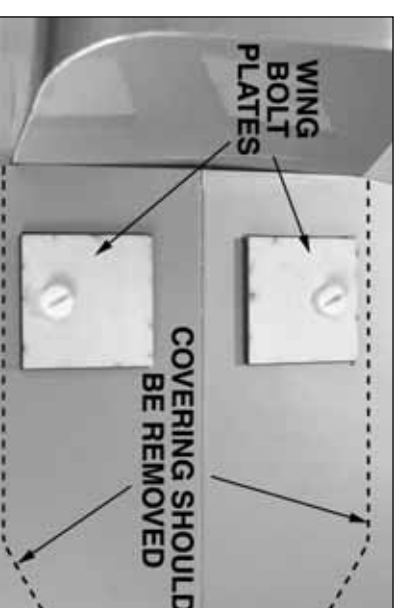

- ❑ 3. Glue the plywood **wing bolt plates** to the bottom of the wing with 30-minute epoxy using the wing bolts to hold them down. (Although the covering is still on the wing in this photo, the covering should be removed from your wing under the air scoop.)



- ❑ 4. Use a fine-point felt-tip pen to mark small lines directly on the wing, noting the location of both wing bolt plates. Reposition the air scoop on the wing, then mark the same lines on both sides of the air scoop.



- ❑ 5. Cut the inside of the air scoop at the lines to accommodate the wing bolt plates.



- ❑ 6. Use the same procedure to mark the location of the wing bolts on the air scoop. Using the marks on the scoop as a guide, cut 1/2" [13mm] holes through the bottom of the scoop for wing bolts.

- ❑ 7. Roughen the lip around the base of the scoop so glue will adhere. Place a sheet of wax paper between the wing and the fuselage.

- ❑ 8. Glue the air scoop to the bottom of the wing with 30-minute epoxy mixed with microballoons. Hold the air scoop down with weights and use paper towel squares dampened with alcohol to clean up epoxy that squeezes out.

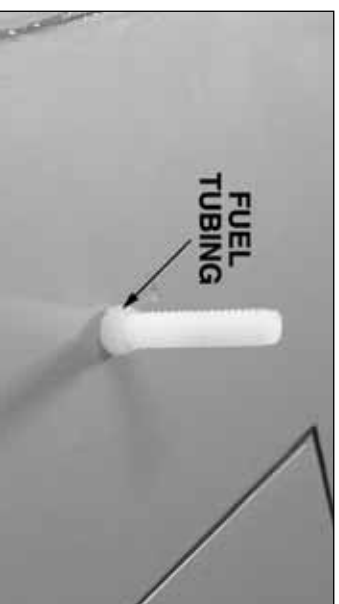

- ❑ 9. Unbolt the wing after the epoxy hardens. Slip pieces of fuel tubing over the wing bolts so they don't fall out.

Wing fairing



- ❑ 1. Bolt the wing to the fuselage. Test fit the fiberglass **wing fairing** to the wing and fuselage. Trim the wing fairing as necessary to fit.

- ❑ 2. Trace the outline of the wing fairing onto the wing. Cut away the covering 1/32" [1mm] inside the line.



- ❑ 3. Roughen the inside of the wing fairing around the edges where it will contact the wing. Holding the wing fairing in position, glue it to the wing with medium CA.

Wing fillets



❑ 1. The same as the air scoop and wing fairing, position the fiberglass wing fillets on the wing and fuselage and trace their outline onto the fuselage. Remove the wing. Cut the covering on the fuselage 1/16" [2mm] inside the lines and peel off the covering. (Cutting 1/32" [1mm] inside the lines was appropriate for the air scoop and wing fairing, but 1/16" [2mm] is better for the wing fillets.)

❑ 2. Lay a sheet of wax paper or a plastic film (cut from a plastic bag) over the top of the wing to protect it from glue. Mount the wing. Use coarse sandpaper to **thoroughly** roughen the inside surface of the wing fillets where they contact the fuselage.

3. Without using any glue, test fit one of the fillets to the fuselage and wing. Press the fillet to the fuselage noting where pressure will be required to make it fit best when actually gluing it on. Remove the fillet.

❑ 4. Apply a bead of medium CA all the way down the wing fillet approximately 1/8" [3mm] from the top edge. Apply another bead of medium CA down the middle. Do not apply any CA near the bottom of the fillet so glue does not drip out (although it wouldn't be a disaster as the wing is protected).

❑ 5. Rest the fillet on the wing about 1" [25mm] away from the fuselage. Then, working quickly, slide the fillet up to the fuselage tightly holding it down to the wing and to the fuselage. Do not relieve pressure until the CA hardens enough to securely hold the fillet in place.

❑ 6. Glue the other wing fillet to the fuselage the same way.

❑ 7. Remove the wing and place the fuselage upside-down in your building stand. Apply medium CA to any gaps between the fillets and the fuselage sides.

Machine guns

❑ 1. Cut out the molded plastic **machine guns** first by cutting 1/8" [3mm] outside the molded-in cutlines, then by cutting on the lines. True the edges with a bar sander and 180-grit sandpaper. Smooth the edges with 400-grit sandpaper.

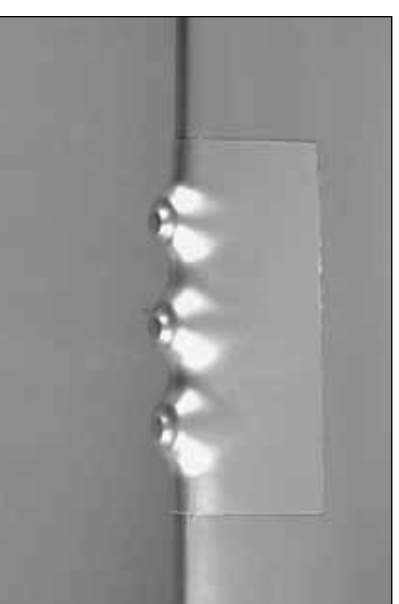
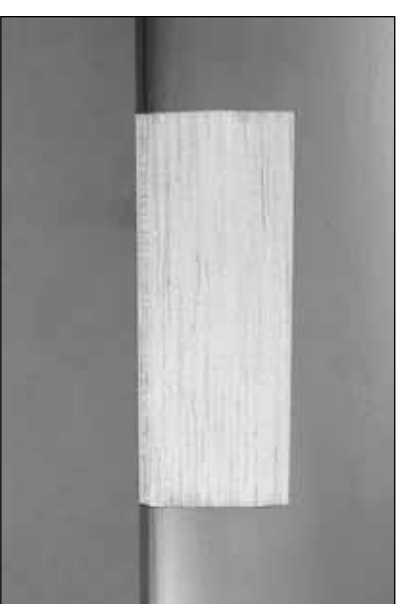
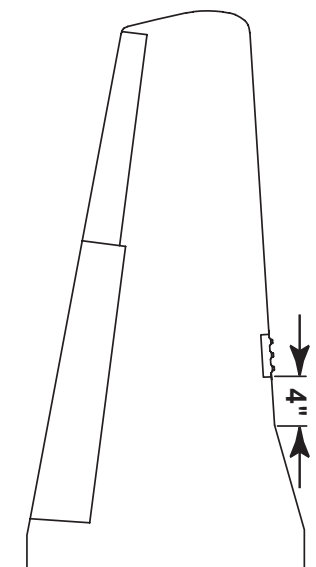

❑ 2. The same as was done with the other molded parts, position the machine guns on the wing 4" [100mm] from the "break" in the leading edge, trace their outline, cut and remove the covering, then glue the machine guns to the wing with medium CA.

Engine Exhaust



- ❑ 1. Cut out the molded plastic **engine exhaust pipes** leaving an approximately 3/32" [2mm] ridge all the way around. True the edges with a bar sander and 180-grit sandpaper. Smooth the edges with 400-grit sandpaper.

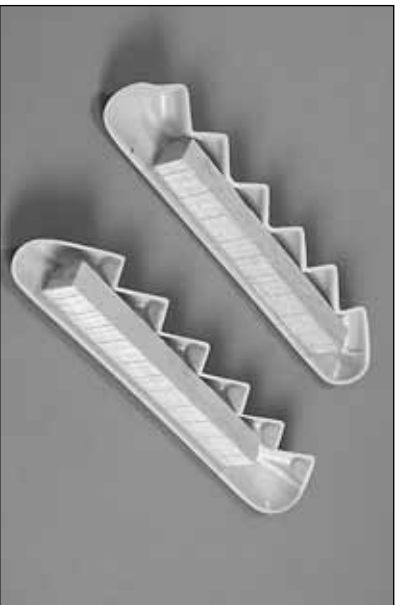

- ❑ 2. Use medium CA to glue a 3/4" x 3/4" x 7" [20 x 20 x 180mm] balsa stick to the inside of each exhaust pipe.

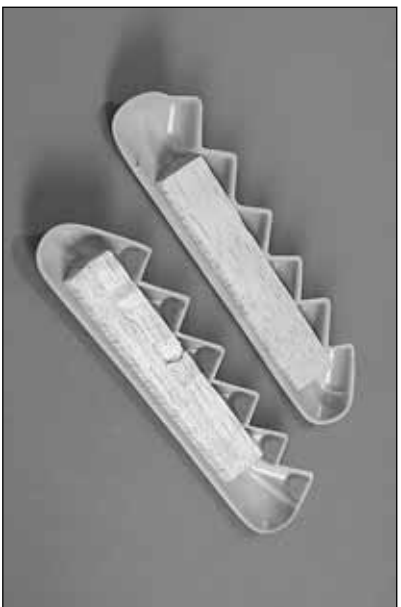

- ❑ 3. Trim the balsa sticks until they are even with the gluing surface of the exhaust pipes.

Refer to this photo for the following three steps.



- ❑ 1. Test fit one of the exhaust pipes to the cowl where shown in the photo. Use coarse sandpaper to sand the cowl where the balsa inside the pipes will be glued on.
- ❑ 2. Apply a coating of microballoons mixed with 30-minute epoxy to the balsa stick inside one of the pipes. Position the pipes on the cowl and hold them down with rubber bands or masking tape. Wipe away excess epoxy before it hardens.

- ❑ 3. After the epoxy from the previous step hardens, glue the other set of exhaust pipes to the other side.

- 36 -

Canopy and pilot



- ❑ 1. Determine how you will be mounting the pilot. In the model depicted in the manual, a Williams Brother's #625 3" (1/4-scale) Standard pilot (WBRQ22625) was used and mounted to a mounting plate made from 1/8" [3mm] lite-ply (not included) that was painted black. Test fit the pilot and place the canopy on the fuselage. Make certain the pilot does not contact the canopy. Make adjustments as necessary.

- ❑ 2. Paint the pilot and mounting plate if used. Acrylic modeling paint (found at hobby shops and craft stores) is suitable.

- ❑ 3. **Securely** mount the mounting plate and pilot in the cockpit.



- ❑ 4. Wash the canopy in warm, soapy water, then dry it off. Place the canopy on the fuselage. Be certain it is centered from side-to-side. Temporarily tape the canopy into position. Drill four evenly spaced 1/16" [1.6mm] holes through both sides of the canopy and the cockpit sides. Take the canopy off and enlarge the holes **in the canopy only** with a 3/32" [2.4mm] drill. Mount the canopy with eight #2 x 3/16" [4.8mm] screws.

- ❑ 5. Remove the canopy and screws. Add a few drops of thin CA to the holes to harden the threads. Allow the CA to fully harden, then remount the canopy.

Apply the decals

1. Use scissors or a sharp hobby knife to cut the decals from the decal sheets. Where possible, round the corners so they won't catch and lift while cleaning and handling the model.

2. Be certain the model is clean. Prepare a dishpan or small bucket with a mixture of liquid dish soap and warm water—about 1/2 teaspoon of soap per gallon of water. Submerge one of the decals in the solution and peel off the paper backing. **Note:** Even though the decals have a "sticky-back" and are not the water transfer type, submerging them in soap and water allows accurate positioning and reduces air bubbles underneath.

3. Position the decal on the model where desired. Holding the decal down, use a paper towel to wipe most of the water away.

4. Use a piece of soft balsa or something similar to squeeze remaining water from under the decal. Apply the rest of the decals the same way.

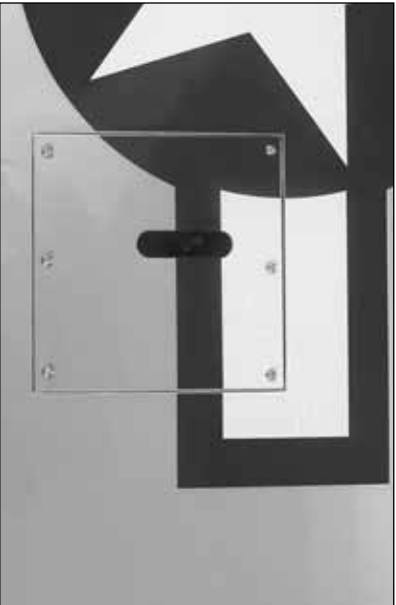

- ❑ **Note:** To apply the stars and bars on the bottom of the right wing, remove the aileron servo hatch. Apply the decal. Squeeze the water out, then cut along the edges of the hatch. Position the hatch. Apply the cut off portion of the decal to the hatch.

GET THE MODEL READY TO FLY

Complete the radio installation

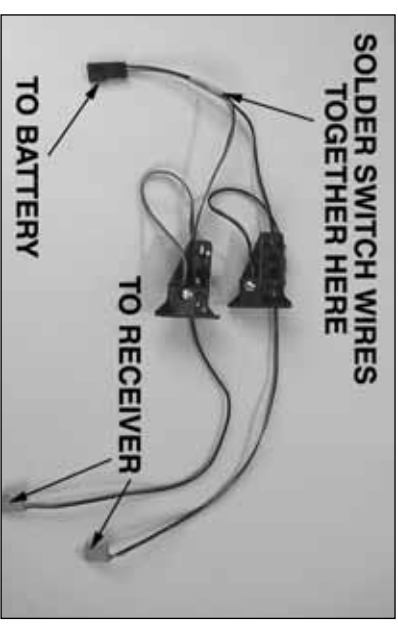

- ❑ 1. Mount the receiver on/off switch in a strategic location where it won't interfere with anything inside the fuselage and where it will not get coated with engine exhaust outside the fuselage. Due to the higher levels of vibration from some gas engines, two switches may be used for redundancy. If using two switches, solder the wires together as shown. A Great Planes Switch & Charge Jack Mounting Set (GPM1000) was also used for charging and voltage monitoring from outside the fuselage.





- ❑ 2. Securely mount the receiver and battery using 1/4" or 1/2" [6 or 13mm] R/C foam rubber to protect them from vibration. The included Velcro strips may be used to secure them where preferred. On the prototype test models the battery was mounted to the top of the wing bolt plate in the fuselage and the receiver was mounted to the forward servo tray. If preferred, the battery location could be determined while balancing the model, thus reducing or eliminating any additional ballast required to get the model to balance.

- ❑ 3. Connect the battery, switch(es) and servos to the receiver. Use servo extensions or Y-connectors where necessary (on the model shown in the photo, 6" or 8" [150 or 200mm] servo extensions were required for each elevator servo, and for the battery and the aileron plug in the receiver).

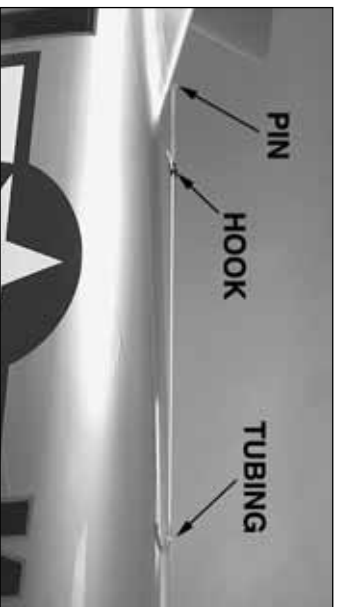

- ❑ 4. Make a **strain relief** for the receiver antenna from a leftover servo arm. Install the strain relief near

the end of the antenna where it enters the receiver. Drill 3/32" holes through a few of the formers to guide the receiver antenna away from the servos and wires. Guide the antenna through a hole in the fuselage insulated with a piece of leftover air line or fuel tubing. Connect the end of the antenna to a pin stuck into the fin via a rubber band and a **hook** made from another leftover servo arm.

Balance the Model (C.G.)

More than any other factor, the **C.G.** (balance point) can have the **greatest** effect on how a model flies and may determine whether or not your first flight will be successful. If you value this model and wish to enjoy it for many flights, **DO NOT OVERLOOK THIS IMPORTANT PROCEDURE.** A model that is not properly balanced will be unstable and possibly unflyable.

The model should be in **ready-to-fly** condition with all of the systems in place including the landing gear, engine, propeller, spinner, etc. It is advisable to have two people to balance the model—one to hold the model (or place it on the balance stand) and one to view it from the side to see if the stabilizer is level.

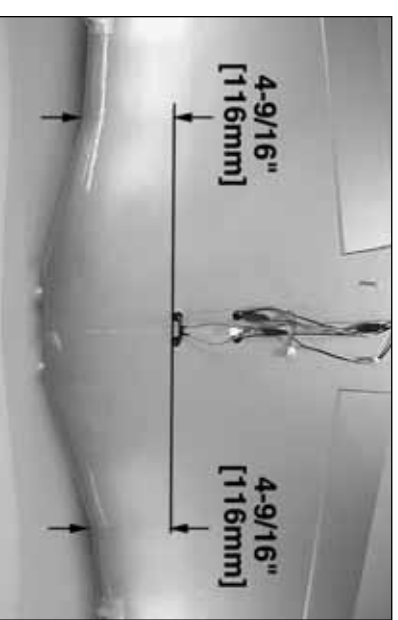
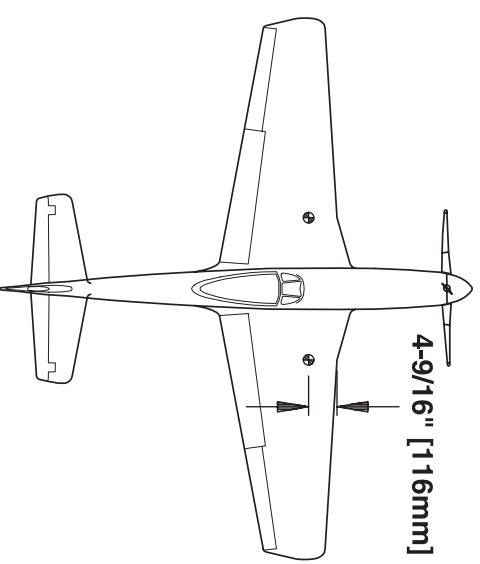

- ❑ 1. If using a Great Planes C.G. Machine to balance the model, set the rulers to **4-9/16" [116mm]** and adjust the bases so the upright rods are spaced approximately 22-1/2" [570mm] apart (to support the wing at the "break" in the leading edge as shown in the sketch). If not using a C.G. machine, accurately mark the C.G. on the top of both sides of the wing **4-9/16" [116mm]** from the "break" in the leading edge with a fine-point felt-tip pen. Connect the marks with a strip of 1/8" [3mm] (or narrower) tape. (You will be able to feel the tape line when lifting the model upside-down with your fingers.)

This is where your model should balance for the first flights. Later, you may wish to experiment by shifting the C.G. up to 5/16" [8mm] forward or 5/16" [8mm] back to change the flying characteristics. Moving the C.G. forward may improve the smoothness and stability, but the model may then require more speed for takeoff and make it more difficult to slow for landing. Moving the C.G. aft makes the model more maneuverable, but could also cause it to become too difficult to control. In any case, **start at the recommended balance point** and do not at any time balance the model outside the specified range. **Note:** If flying the model at the forward C.G. location, you should land with the elevator throws (provided on page 40) set to the **high** rate. If the model is nose-heavy the low-rate throws may not provide enough control to flair upon landing.

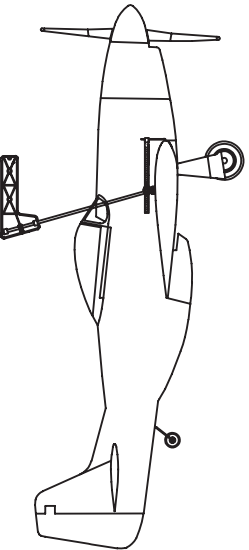

- 2. With the wing attached to the fuselage, all parts of the model installed (ready to fly) and an empty fuel tank, place the model upside-down on the CG Machine, or lift the model upside-down with your finger tips on the tape line.

- 3. When viewing the model from the side, the horizontal stabilizer should be level. If the tail is low, the model is "tail heavy" and the battery pack and/or receiver must be shifted forward or weight must be added to the nose to balance. If the tail is high, the model is "nose heavy" and the battery pack and/or receiver must be shifted aft or weight must be added to the tail to balance. If additional weight is required, Great Planes (GPMQ4485) "stick-on" lead may be

added where necessary. If nose-weight is required attach it to the firewall (don't attach weight to the cowl—it is not intended to support weight). If tail-weight is required it could be attached to the inside of the fuselage through the tail gear door opening. In either case, do not rely upon the adhesive on the back of the lead weight to permanently hold it in place. Over time, fuel and exhaust residue may soften the adhesive and cause the weight to fall off. Instead, use #2 sheet-metal screws, RTV silicone or epoxy to permanently hold the weight in place.

- 4. **IMPORTANT:** If you found it necessary to add any weight, recheck the C.G. after the weight has been installed.

Balance the Model Laterally

- 1. With the wing level, have an assistant help you lift the model by the engine propeller shaft and the bottom of the fuse under the TE of the fin. Do this several times.

- 2. If one wing always drops when you lift the model, it means that side is heavy. Balance the airplane by adding weight to the other wing tip. Weight may be temporarily adhered to the bottom of the wing tip with the adhesive foam tape that comes with it, then permanently glued inside after doing the necessary in-flight checks to determine the exact amount of weight necessary. **An airplane that has been laterally balanced will track better in loops and other maneuvers.**

Check the Control Directions

- 1. Turn on the transmitter and receiver and center the trims. If necessary, remove the servo arms from the servos and reposition them so they are centered. Reinstall the screws that hold on the servo arms.

- 2. Adjust the length of any pushrods necessary and the pull/pull cables on the tail wheel by screwing

the clevises in or out. Securely tighten all the 4-40 jam nuts on the 4-40 pushrods to lock the clevises down. This would also be a good time to study the installation of all the systems to make sure everything is secure and connected properly (air lines, servo wires, receiver antenna, etc.).

- 3. Make certain all the controls respond in the correct direction. If any of the controls respond in the wrong direction, use the servo reversing in the transmitter to reverse the servos connected to those controls. Be certain the control surfaces have remained centered. Adjust if necessary.

Set the Control Throws



Use a Great Planes AccuThrow (or a ruler) to accurately measure and set the control throw of each control surface as indicated in the chart that follows. **NOTE:** The throws are measured at the **widest part** of the elevators, rudder ailerons and flaps.

These are the recommended control surface throws:

	High Rate	Low Rate
ELEVATOR	9/16" up [14mm] 9/16" down [14mm]	3/8" up [10mm] 3/8" down [10mm]
RUDDER	1-1/2" right 1-1/2" left [38mm]	1" right 1" left [25mm]
AILERONS:	3/4" up [19mm] 5/8" down [16mm]	1/2" up [13mm] 3/8" down [10mm]
FLAPS:	Half Rate 1-3/16" [30mm]	Full Rate 2-1/8" [55mm]

Note: If flying the model at the forward C.G. location, you should land with the elevator throws set to the **high** rate. If the model is nose-heavy the low-rate throws may not provide enough control to flair upon landing.

IMPORTANT: The Top Flite Giant P-51D Mustang ARF has been **extensively** flown and tested to arrive at the throws at which it flies best. Flying your model at these throws will provide you with the greatest chance for successful first flights. If, after you have become accustomed to the way the Mustang flies, you would like to change the throws to suit your taste, that is fine. However, too much control throw could make the model difficult to control, so remember, "more is not always better."

Balance Propellers

Carefully balance your propeller and spare propellers before you fly. An unbalanced prop can be the single most significant cause of vibration that can damage your model. Not only will engine mounting screws and bolts loosen, possibly with disastrous effect, but vibration may also damage your radio receiver and battery. Vibration can also cause your fuel to foam, which will, in turn, cause your engine to run hot or quit.



We use a Top Flite Precision Magnetic Prop Balancer™ (TOPQ5700) in the workshop and keep a Great Planes Fingertip Prop Balancer (GPMQ5000) in our flight box.

CHECK LIST

During the last few moments of preparation your mind may be elsewhere anticipating the excitement of the first flight. Because of this, you may be more likely to overlook certain checks and procedures that should be performed before the model is flown. To help avoid this, a checklist is provided to make sure these important areas are not overlooked. Many are covered in the instruction manual, so where appropriate, refer to the manual for complete instructions. Be sure to check the items off as they are completed (that's why it's called a *check list!*).

1. Fuelproof all areas exposed to fuel or exhaust residue such as the cowl mounting blocks, wing saddle area, etc.
2. Check the C.G. according to the measurements provided in the manual.
3. Be certain the battery and receiver are **securely** mounted in the fuselage. Simply stuffing them into place with foam rubber is not sufficient.
4. Extend the receiver antenna and make sure it has a strain relief inside the fuselage to keep tension off the solder joint inside the receiver.
5. Balance the model *laterally* as explained in the instructions.
6. Use threadlocking compound to secure critical fasteners such as the nuts that hold the wheel axles to the struts, screws that hold the carburetor arm (if applicable), set screws that hold the tail gear components, etc.
7. Add a drop of oil to the axles so the wheels will turn freely.
8. Make sure all hinges are **securely** glued in place.
9. Reinforce holes for wood screws with thin CA where appropriate (servo mounting screws, cowl mounting screws, etc.).
10. Confirm that all controls operate in the correct direction and that the throws are set up according to the manual.
11. Make sure there are silicone retainers on all the clevises and that all servo arms are secured to the servos with the screws included with your radio.
12. Secure connections between servo wires and Y-connectors or servo extensions, and the connection between your battery pack and the on/off switch with vinyl tape, heat shrink tubing or special clips suitable for that purpose.
13. Make sure none of the servo wires or air lines interfere with any moving parts (servo arms, pushrods, retracts, etc.).
14. Make sure the fuel lines are connected and are not kinked.
15. Securely tighten the propeller nut. Remove the 3mm screws that hold the spinner cone to the backplate. Add a small drop of thread locking compound to the screws, then reinstall the screws.

- 16. Balance the propeller and spare propellers.
- 17. Place your name, address, AMA number and telephone number on or inside the model.
- 18. Cycle the receiver battery pack (if necessary) and make sure it is fully charged.
- 19. If you wish to photograph your model, do so before your first flight.
- 20. Perform a range check when you get to the flying field.

PREFLIGHT

Identify Your Model

No matter if you fly at an AMA sanctioned R/C club site or if you fly somewhere on your own, you should always have your name, address, telephone number and AMA number on or inside your model. It is **required** at all AMA R/C club flying sites and AMA sanctioned flying events. Fill out the identification tag on page 47 and place it on or inside your model.

Charge the Batteries

Follow the battery charging instructions that came with your radio control system to charge the batteries. You should always charge your transmitter and receiver batteries the night before you go flying, and at other times as recommended by the radio manufacturer.

NOTE: Checking the condition of your receiver battery pack is **highly recommended**. All battery packs, whether it's a trusty pack you've just taken out of another model, or a new battery pack you just purchased, should be cycled, noting the discharge capacity. Oftentimes, a weak battery pack can be identified (and a valuable model saved!) by comparing its actual capacity to its rated capacity. Refer to the instructions and recommendations that come with your cycler. If you don't own a battery cycler, perhaps you can have a friend cycle your pack and note the capacity for you.

Ground Check

If the engine is new, follow the engine manufacturer's instructions to break-in the engine. After break-in, confirm that the engine idles reliably, transitions smoothly and rapidly to full power and maintains full power—*indefinitely*. After you run the engine on the model, inspect the model closely to make sure all screws remained tight, the hinges are secure, the prop is secure and all pushrods and connectors are secure.

Range Check

Ground check the operational range of your radio before the first flight of the day. With the transmitter antenna collapsed and the receiver and transmitter on, you should be able to walk at least 100 feet away from the model and still have control. Have an assistant stand by your model and, while you work the controls, tell you what the control surfaces are doing. Repeat this test **with the engine running** at various speeds with an assistant holding the model, using hand signals to show you what is happening. If the control surfaces do not respond correctly, **do not fly!** Find and correct the problem first. Look for loose servo connections or broken wires, corroded wires on old servo connectors, poor solder joints in your battery pack or a defective cell, or a damaged receiver crystal from a previous crash.

ENGINE SAFETY PRECAUTIONS

Failure to follow these safety precautions may result in severe injury to yourself and others.

Keep all engine fuel in a safe place, away from high heat, sparks or flames, as fuel is very flammable. Do not smoke near the engine or fuel; and remember that engine exhaust gives off a great deal of deadly carbon monoxide. Therefore **do not run the engine in a closed room or garage.**

Get help from an experienced pilot when learning to operate engines.

Use safety glasses when starting or running engines.

Do not run the engine in an area of loose gravel or sand; the propeller may throw such material in your face or eyes.

Keep your face and body as well as all spectators away from the plane of rotation of the propeller as you start and run the engine.

Keep these items away from the prop: loose clothing, shirt sleeves, ties, scarfs, long hair or loose objects such as pencils or screwdrivers that may fall out of shirt or jacket pockets into the prop.

Use a "chicken stick" or electric starter to start the engine. Do not use your fingers to flip the propeller. Make certain the glow plug clip or connector is secure so that it will not pop off or otherwise get into the running propeller.

Make all engine adjustments from behind the rotating propeller.

The engine gets hot! Do not touch it during or right after operation. Make sure fuel lines are in good condition so fuel will not leak onto a hot engine, causing a fire.

To stop a glow engine, cut off the fuel supply by closing off the fuel line or following the engine manufacturer's recommendations. Do not use hands, fingers or any other body part to try to stop the engine. To stop a gasoline powered engine an on/off switch should be connected to the engine coil. Do not throw anything into the propeller of a running engine.

AMA SAFETY CODE (excerpts)

Read and abide by the following Academy of Model Aeronautics Official Safety Code:

GENERAL

1. I will not fly my model aircraft in sanctioned events, air shows, or model flying demonstrations until it has been proven to be airworthy by having been previously successfully flight tested.
2. I will not fly my model aircraft higher than approximately 400 feet within 3 miles of an airport without notifying the airport operator. I will give right of way to, and avoid flying in the proximity of full scale aircraft. Where necessary an observer shall be used to supervise flying to avoid having models fly in the proximity of full scale aircraft.
3. Where established, I will abide by the safety rules for the flying site I use, and I will not willfully and deliberately fly my models in a careless, reckless and/or dangerous manner.
7. I will not fly my model unless it is identified with my name and address or AMA number, on or in the model.
9. I will not operate models with pyrotechnics (any device that explodes, burns, or propels a projectile of any kind).

RADIO CONTROL

1. I will have completed a successful radio equipment ground check before the first flight of a new or repaired model.
2. I will not fly my model aircraft in the presence of spectators until I become a qualified flier, unless assisted by an experienced helper.
3. I will perform my initial turn after takeoff away from the pit or spectator areas, and I will not thereafter fly over pit or spectator areas, unless beyond my control.

4. I will operate my model using only radio control frequencies currently allowed by the Federal Communications Commission...

Since the Giant P-51D Mustang ARF qualifies as a "giant scale" model and is therefore eligible to fly in IMAA events, we've printed excerpts from the IMAA Safety Code which follows.

IMAA SAFETY CODE (excerpts)

Definition:

For the purpose of the following IMAA Safety Code, the term Giant Scale shall refer to radio controlled model aircraft, either scale or non-scale, which have a wingspan of 80 inches or more for monoplanes and 60 inches or more for multi-winged model aircraft and have a ramp weight (fueled and ready to fly) of 55 lbs. or less.

Section 1.0: SAFETY STANDARD

- 1.1 Adherence to Code: This safety code is to be strictly followed
- 1.2 The most current AMA Safety Code in effect is to be observed. However, the competition sections of the code may be disregarded.

Section 3.0: Safety Check

- 3.4 Flight Testing: All Giant Scale R/C aircraft are to have been flight tested and flight trimmed with a minimum of six flights before the model is allowed to fly at an IMAA Sanctioned event.

- 3.5 Proof of Flight: The completing and signing of the Declaration section of the Safety Inspection form by the pilot (or owner) shall document as fact that each aircraft has been successfully flight-tested and proven airworthy prior to an IMAA event.

Section 5.0: EMERGENCY ENGINE SHUT OFF (kill switch)

- 5.1 All magneto spark ignition engines must have a coil grounding switch on the aircraft to stop the engine. This will also prevent accidental starting of the engine. This switch shall be readily available to both pilot and helper. This switch is to be operated manually and without the use of the radio system.

- 5.2 Engines with battery power ignition systems must have a switch to turn off the power from the battery pack to disable the engine from firing. This will also prevent accidental starting of the engine. This switch shall be readily available to both pilot and helper. This switch shall be operated manually and without the use of the Radio System.

- 5.3 There must also be a means to stop the engine from the transmitter. The most common method is to close the carburetor throat completely using throttle trim. However, other methods are acceptable. This requirement applies to all glow/gas ignition engines regardless of size.

Section 6.0: RADIO REQUIREMENTS

- 6.1 All transmitters must be FCC type certified.
- 6.2 FCC Technician or higher-class license required for 6 meter band operation only.

Additional IMAA General Recommendations

The following recommendations are included in the Safety Code not to police such items, but rather to offer basic suggestions for enhanced safety:

Servos need to be of a rating capable to handle the loads that the control surfaces impose upon the servos. Standard servos are not recommended for control surfaces. Servos should be rated heavy-duty. For flight-critical control functions a minimum of 45 inch/ounces of torque should be considered. This should be considered a minimum for smaller aircraft

and higher torque servos are strongly encouraged for larger aircraft. The use of one servo for each aileron and one for each elevator half is strongly recommended. Use of dual servos is also recommended for larger aircraft.

On-board batteries shall be 1000 mAh up to 20 lbs., 1200 mAh to 30 lbs., 1800 mAh to 40 lbs. and 2000 mAh over 40 lbs. flying weight. The number and size of servos, size and loads on control surfaces, and added features should be considered as an increase to these minimums. Batteries should be able to sustain power to the onboard radio components for a minimum of one hour total flying time before recharging.

Both redundant and fail-safe battery systems are recommended.

The use of anti-glitch devices for long leads are recommended.

There is no maximum engine displacement limit, as it is the position of this body that an underpowered aircraft presents a greater danger than an overpowered aircraft. However, the selection of engine size relative to airframe strength and power loading mandates good discretionary judgment by the designer and builder. Current AMA maximums for engine displacement are 6.0 cu. in. for two-stroke and 9.6 cu. in. for four-stroke engines. These maximums apply only to AMA Sanctions concerning competition events (such as 511, 512, 515 and 520) and, as such, the maximums apply. All IMAA (non competition) events should be sanctioned as Class "C" events, in which these engine size maximums do not apply.

Generally, it is recommended that no attempt should be made to fly a radio controlled model aircraft with a gasoline engine in which the model aircraft weight would exceed twelve (12) pounds (underpowered) per cubic inch of engine displacement, or be less than five (5) pounds (overpowered) per cubic inch of engine displacement. Example: Using a 3 cu. in. engine, a model would likely be underpowered at an

aircraft weight greater than 36 pounds. With the same engine, an aircraft weighing less than 15 pounds would likely be overpowered.

Servo arms and wheels should be rated heavy duty. Glass-filled servo arms and control horns are highly recommended.

Control surfaces linkages are listed in order of preference:

1. Cable system (pull-pull). A tiller bar is highly recommended along with necessary bracing.

2. Arrow Shaft, fiberglass or aluminum, 1/4" or 5/16" [6 or 8mm] O.D. bracing every six (6) to ten (10) inches is highly recommended.

3. Tube-in-tube (nyrod). Bracing every few inches is highly recommended. Inner tube should be totally enclosed in outer tube.

4. Hardwood dowel, 3/8" O.D. bracing every six (6) to ten (10) inches is highly recommended.

Hinges should be rated heavy duty and manufactured for Giant Scale use primarily. Homemade and original design hinges are acceptable if determined to be adequate for the intended use.

Clevis (steel, excluding heavy-duty ball links) and attachment hardware should be heavy duty 4-40 threaded rod type. 2-56 threaded size rod is acceptable for some applications (e.g. throttle). Clevis is to have lock nuts and sleeve or spring keepers.

Propeller tips should be painted or colored in a visible and contrasting manner so as to increase the visibility of the propeller tip arc.

FLYING

The Top Flite Giant P-51D Mustang ARF is a great-flying model that flies smoothly and predictably. The Mustang does not, however, possess the self-recovery characteristics of a primary R/C trainer and should be flown only by experienced R/C pilots.

Fuel Mixture Adjustments

A fully cowed engine may run at a higher temperature than an un-cowed engine. For this reason, the fuel mixture should be richened so the engine runs at about 200 rpm below peak speed. By running the engine slightly rich, you will help prevent dead-stick landings caused by overheating.

CAUTION (THIS APPLIES TO ALL R/C AIRPLANES): If, while flying, you notice an alarming or unusual sound such as a low-pitched "buzz," this may indicate control surface flutter. Flutter occurs when a control surface (such as an aileron or elevator) or a flying surface (such as a wing or stab) rapidly vibrates up and down (thus causing the noise). In extreme cases, if not detected immediately, flutter can actually cause the control surface to detach or the flying surface to fail, thus causing loss of control followed by an impending crash. The best thing to do when flutter is detected is to slow the model **immediately** by reducing power, then land as soon as safely possible. Identify which surface fluttered (so the problem may be resolved) by checking all the servo grommets for deterioration or signs of vibration. Make certain all pushrod linkages are secure and free of play. If it fluttered once, under similar circumstances it will probably flutter again unless the problem is fixed. Some things which can cause flutter are: Excessive hinge gap; Not mounting control horns solidly; Poor fit of clevis pin in horn; Side-play of wire pushrods caused by large bends; Excessive free play in servo gears; Insecure servo mounting; and one of the most prevalent causes of flutter; Flying an over-powered model at excessive speeds.

Takeoff

Before you get ready to takeoff, see how the model handles on the ground by doing a few practice runs at **low speeds** on the runway. Hold “up” elevator to keep the tail wheel on the ground. If necessary, adjust the tail wheel so the model will roll straight down the runway. If you need to calm your nerves before the maiden flight, shut the engine down and bring the model back into the pits. Top off the fuel, then check all fasteners and control linkages for peace of mind.

If possible, takeoff directly into the wind. The Giant P-51 handles crosswind takeoffs well, but taking off directly into the wind is usually desired—use the rudder as necessary to maintain heading. When ready, advance the throttle and hold a bit of up elevator to keep the tail on the ground to maintain tail wheel steering. As the model gains speed decrease up elevator allowing the tail to come off the ground. One of the most important things to remember with a tail dragger that has a large engine is to always be ready to apply **right** rudder to counteract engine torque. Gain as much speed as your runway and flying site will practically allow before gently applying up elevator lifting the model into the air. At this moment it is likely that you will need to apply more right rudder to counteract engine torque. Be smooth on the elevator stick and retract the gear when comfortable. Allow the model to establish a **gentle** climb to a safe altitude before turning into the traffic pattern.

Flight

For reassurance and to keep an eye on other traffic, it is a good idea to have an assistant on the flight line with you. Tell him to remind you to throttle back once the plane gets to a comfortable altitude. While full throttle is usually desirable for takeoff, most models fly more smoothly at reduced speeds.

Take it easy with the Mustang for the first few flights, gradually getting acquainted with it as you gain confidence. Adjust the trims to maintain straight and level flight. After flying around for a while, and while

still at a safe altitude with plenty of fuel, practice slow flight and execute practice landing approaches by reducing the throttle to see how the model handles at slower speeds. Add power to see how she climbs as well. Continue to fly around, executing various maneuvers and making mental notes (or having your assistant write them down) of what trim or C.G. changes may be required to fine tune the model so it flies the way you like. Mind your fuel level, but use this first flight to become familiar with your model before landing.

Landing

One of the keys to landing a giant-scale model is to maintain sufficient airspeed throughout the landing approach. An unusually high airspeed is not necessary, but those unfamiliar with landing giant-scale models are sometimes deceived by the model's larger size. Larger models often appear to be closer than they actually are. Additionally, most giant-scale models slow down rapidly, thus causing the uninitiated to land short. To avoid this initial illusion, make your landing pattern closer than you normally might for a .40-size sport model. Also, don't pull the throttle all the way back and leave it there the way you normally would. Instead, momentarily pull the throttle all the way back, but then advance it a “click” or two to keep the engine RPM up and maintain airspeed. Once over the runway you can cut the throttle the rest of the way and the model will slow for the landing flare.

The P-51 may be landed with or without flaps. Flaps increase lift and drag, so the plane may be landed slower, thus reducing rollout after touchdown (not as much of a factor on grass runways). To initiate a landing approach, lower the throttle while on the downwind leg. If using flaps, allow the model to slow before extending them. Continue to lose altitude, but maintain airspeed by keeping the nose down as you turn onto the crosswind leg. Make the final turn toward the runway (into the wind) keeping the nose down to maintain airspeed and control. If using flaps keep a few additional “clicks” of power so the model doesn't slow **too** much. Level the attitude when the

model reaches the runway threshold, modulating the throttle as necessary to maintain the glide path and airspeed. If overshooting, smoothly advance the throttle (always ready on the right rudder to counteract torque) and retract the flaps when enough airspeed is gained. Climb out to make another attempt. When the model is a foot or so off the deck and you are ready to make the landing flare, smoothly increase up elevator until it gently touches down. Once the model is on the runway and has lost flying speed, hold up elevator to hold the tail on the ground, thus maintaining tail wheel steering. **Note:** If ever the occasion arises when a dead-stick landing must be performed, do not extend the flaps until **certain** the model will be able to reach the landing zone (on dead-stick landings it is common to land with no flaps at all). Without engine power, flaps can unexpectedly reduce the model's range, thus causing you to come up short of the field.

One final note about flying your Giant P-51. Have a goal or flight plan in mind for **every** flight. The goal could be learning a new maneuver, perfecting known maneuvers, or learning how the model behaves in certain conditions (such as on high or low rates). This is not necessarily to improve your skills (*though it is never a bad idea!*), but more importantly so you do not surprise yourself by **impulsively** attempting a maneuver without any planning. Every maneuver should be deliberate. For example, if you're going to do a loop, plan it out—check your altitude, mind the wind direction (anticipating rudder corrections that will be required to maintain heading), remember to throttle back on the down side, and make certain you are on the desired rates (high/low rates). A flight plan greatly reduces the chances of crashing just because of poor planning and impulsive moves. **Remember to think!**

Have a ball! But always stay in control and fly in a safe manner.

GOOD LUCK AND GREAT FLYING!

U.S. Engines™ 41cc 2.5 R/C Engine (USEG0041)



Economical gasoline power for quarter- and giant-scale.

Boost realism and cut fuel costs! The 41cc burns an inexpensive blend of unleaded gasoline and 2-cycle oil for fuel; plus, the included spring-starter makes an electric starter, starter battery and glow starter unnecessary. Other features: Internal, solid state electronic ignition; smooth, dynamically balanced flywheel; chrome-plated cylinder bore; full roller bearings; engine mount; and a 2-year warranty.

Great Planes® Electrify™ Triton™ (GPMM3150) Computerized DC Peak Charger/Discharger/Cycler



Great for almost any rechargeable R/C battery!

It weighs barely a pound and measures only about the size of a thick paperback book - but the Triton is so versatile, you can use it with lithium-ion, lithium polymer and lead-acid batteries as effectively as NiCd and NiMH cells. It will peak tiny park flyer packs and 24V car batteries alike - and can discharge as well as charge, cycle packs from 1 to 10 times automatically, memorize peak and average battery voltages for each cycle, and constantly display battery capacity, voltage, current and time as each cycle progresses. 1-year warranty.

Futaba® 9C 9-Channel Radio System (FUTJ88**)



More value for the dollar - more possibilities for the pilot!

With a 9C, the sky's the limit - and Dial N' Key programming puts it within easy reach. There's a rotary dial for finding functions, push-buttons to do everything else, and more possibilities than you'd ever imagine. Experiment with triple rates. See the travel of each servo on a bar graph and reset the limits of any you wish. Delete an auxiliary function and substitute a custom mix, or assign it to a different knob or switch - even to one of the two proportional slider switches. Factory programming enables the transmitter to be used for airplanes, helis or sailplanes.

Receiver: R149DP
Tx NiCd: 700mAh
Band: 50, 72MHz

Servos: (4) S9001
Rx NiCd: 1000mAh
Modulation: PCM

Futaba® SR10 Dual Servo Reverser (FUTM4150)



For precise dual servo control without mixing!

With the SR10, you can control two servos on a single channel without special motors or mixing. Easy to install, simple to trim - and equipped with an RF noise filter for signal clarity. Ideal for cars, boats or two-servo control surfaces on large-scale craft. 1-year warranty.

Cut out or make a copy of this identification tag. Fill in the appropriate information and place it on or inside the model.

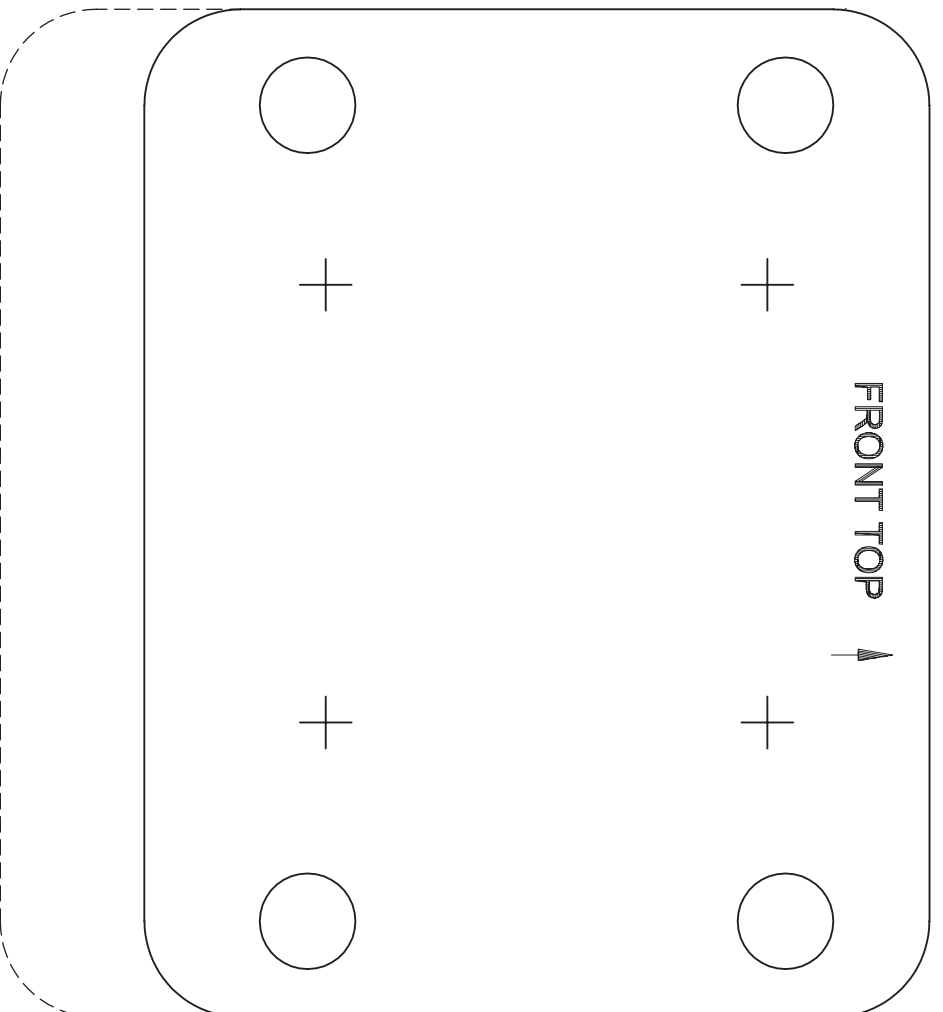

U.S. 41cc ENGINE MOUNT TEMPLATE

This model belongs to: _____

Name

Address

City, State Zip

Phone number

AMA number

This model belongs to: _____

Name

Address

City, State Zip

Phone number

AMA number

