



Bind-N-Fly[®] Ready to fly, redefined.

UMX[™] RADIANT[®]



Instruction Manual
Bedienungsanleitung
Manuel d'utilisation
Manuale di Istruzioni

AS3X[®]

E-flite[®]
ADVANCING ELECTRIC FLIGHT

NOTICE

All instructions, warranties and other collateral documents are subject to change at the sole discretion of Horizon Hobby, Inc. For up-to-date product literature, visit www.horizonhobby.com and click on the support tab for this product.

Meaning of Special Language:

The following terms are used throughout the product literature to indicate various levels of potential harm when operating this product:

NOTICE: Procedures, which if not properly followed, create a possibility of physical property damage AND little or no possibility of injury.

CAUTION: Procedures, which if not properly followed, create the probability of physical property damage AND a possibility of serious injury.

WARNING: Procedures, which if not properly followed, create the probability of property damage, collateral damage and serious injury OR create a high probability of superficial injury.



WARNING: Read the ENTIRE instruction manual to become familiar with the features of the product before operating. Failure to operate the product correctly can result in damage to the product, personal property and cause serious injury.





This is a sophisticated hobby product. It must be operated with caution and common sense and requires some basic mechanical ability. Failure to operate this Product in a safe and responsible manner could result in injury or damage to the product or other property. This product is not intended for use by children without direct adult supervision. Do not use with incompatible components or alter this product in any way outside of the instructions provided by Horizon Hobby, Inc. This manual contains instructions for safety, operation and maintenance. It is essential to read and follow all the instructions and warnings in the manual prior to assembly, setup or use in order to operate correctly and avoid damage or serious injury.

Age Recommendation: Not for children under 14 years. This is not a toy.

Safety Precautions and Warnings

As the user of this product, you are solely responsible for operating it in a manner that does not endanger yourself and others or result in damage to the product or the property of others.

- Always keep a safe distance in all directions around your model to avoid collisions or injury. This model is controlled by a radio signal subject to interference from many sources outside your control. Interference can cause momentary loss of control.
- Always operate your model in open spaces away from full-size vehicles, traffic and people.
- Always carefully follow the directions and warnings for this and any optional support equipment (chargers, rechargeable battery packs, etc.).
- Always keep all chemicals, small parts and anything electrical out of the reach of children.
- Always avoid water exposure to all equipment not specifically designed and protected for this purpose. Moisture causes damage to electronics.
- Never place any portion of the model in your mouth as it could cause serious injury or even death.
- Never operate your model with low transmitter batteries.
- Always keep the aircraft in sight and under control.
- Always use fully charged batteries.
- Always keep the transmitter powered ON while the aircraft is powered.
- Always remove batteries before disassembly.
- Always keep moving parts clean.
- Always keep parts dry.
- Always let parts cool after use before touching.
- Always remove batteries after use.
- Always ensure failsafe is properly set before flying.
- Never operate aircraft with damaged wiring.
- Never touch moving parts.

Box Contents	
Installed	Included
 8.5mm Brushed Motor	 
 DSM2®/DSMX® AS3X Receiver/ESC	
 2 x (SPMSA2030L) on the board	
Required to Complete: DSM2/DSMX 4-Channel Transmitter	

Dual Rates	
High	Low
100 %	70%

Timer Settings	
First Flight 8 Min.	10 Min.

To register your product online, go to www.e-fliterc.com

Specifications

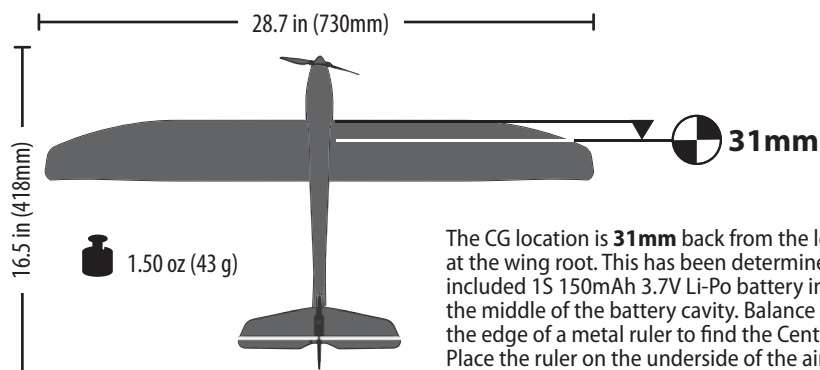

The CG location is **31mm** back from the leading edge at the wing root. This has been determined with the included 1S 150mAh 3.7V Li-Po battery installed in the middle of the battery cavity. Balance the model on the edge of a metal ruler to find the Center of Gravity. Place the ruler on the underside of the airframe.

Preflight Checklist

✓
1. Read this manual thoroughly.
2. Remove and inspect the box contents.
3. Charge the flight battery.
4. Assemble the aircraft.
5. Install the flight battery in the aircraft (once it has been fully charged).
6. Bind the aircraft to the transmitter.

✓
7. Make sure linkages move freely.
8. Perform the Control Direction Test.
9. Adjust the flight controls and transmitter.
10. Find a safe and open area.
11. Plan your flight appropriate for the flying location.

Charging Warnings

The Battery Charger (EFLC1008) included with your aircraft has been designed to safely charge the Li-Po battery.

CAUTION: All instructions and warnings must be followed exactly. Mishandling of Li-Po batteries can result in a fire, personal injury and/or property damage.

- By handling, charging or using the included Li-Po battery, you assume all risks associated with lithium batteries.
- If at any time the battery begins to balloon or swell, discontinue use immediately. If charging or discharging, discontinue and disconnect. Continuing to use, charge or discharge a battery that is ballooning or swelling can result in fire.
- Always store the battery at room temperature in a dry area for best results.
- Always transport or temporarily store the battery in a temperature range of 40–120° F (5–49° C). Do not store the battery or model in a car or direct sunlight. If stored in a hot car, the battery can be damaged or even catch fire.
- Always charge batteries away from flammable materials.
- Always inspect the battery before charging.
- Always disconnect the battery after charging, and let the charger cool between charges.
- Always constantly monitor the temperature of the battery pack while charging.
- ONLY USE A CHARGER SPECIFICALLY DESIGNED TO CHARGE LI-PO BATTERIES. Failure to charge the battery with a compatible charger may cause a fire resulting in personal injury and/or property damage.
- Never discharge Li-Po cells to below 3V under load.
- Never cover warning labels with hook and loop strips.
- Never leave charging batteries unattended.
- Never charge batteries outside recommended levels.
- Never charge damaged batteries.
- Never attempt to dismantle or alter the charger.
- Never allow minors to charge battery packs.
- Never charge batteries in extremely hot or cold places (recommended between 40–120° F (5–49° C)) or place in direct sunlight.

Charging the Battery

Refer to the charging warnings. It is recommended to charge the battery while you inspect the aircraft. The flight battery will be required to confirm proper aircraft operation in future steps.

Battery Charging Process

NOTICE: Charge only batteries that are cool to the touch and are not damaged. Look at the battery to make sure it is not damaged e.g., swollen, bent, broken or punctured.

1. Insert the charger into a USB port.
2. Properly connect the battery into the charger. The end cap of the battery is specifically designed to allow the battery to fit into the slot one way (usually with the label on the battery facing outward) to prevent reverse polarity connection. However, check for proper alignment and polarity.
3. Always disconnect the flight battery from the charger immediately upon completion of charging.

CAUTION: Only use chargers specifically designed to charge the included Li-Po battery. Failure to do so could result in fire, causing injury or property damage.

CAUTION: Never exceed the recommended charge rate.

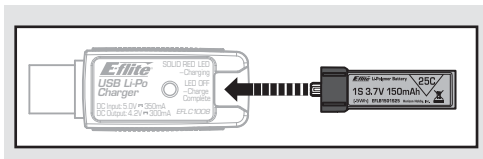

LED Indications

Charging a fully discharged (not over-discharged) 150mAh battery takes approximately 30–40 minutes.

CAUTION: Once charging is complete, immediately remove the battery. Never leave a battery connected to the charger.

CHARGING (Solid Red)..... ●

MAX CHARGE (off)..... ○

Wing Installation

1. Slide the wing into the wing slot on the fuselage until the holes line up with the screw holes on the bottom.
2. Secure the wing using 2 screws.
3. Cut the loop tape (A) into 3 pieces and apply them around the screws in the battery holder, as shown.

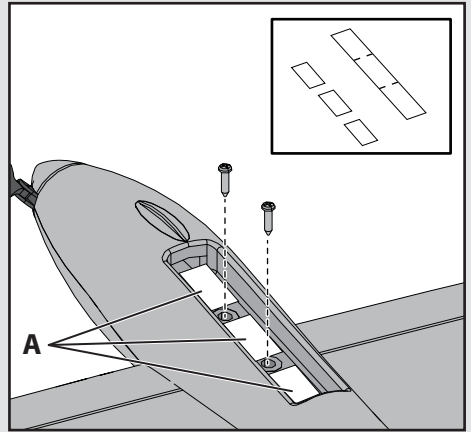
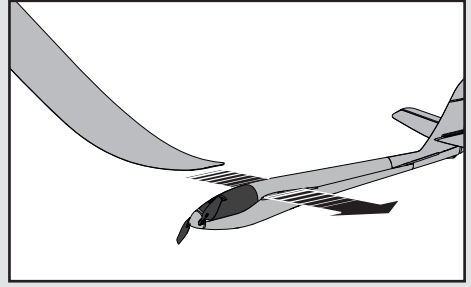

Transmitter and Receiver Binding

✓ Binding Procedure Reference Table	
1.	Refer to your transmitter instructions for binding to a receiver.
2.	Make sure the flight battery is disconnected from the aircraft.
3.	Ensure the transmitter is powered OFF.
4.	Connect the flight battery to the aircraft. The receiver LED will begin to flash (typically after 5 seconds).
5.	Make sure the transmitter controls are at neutral and the throttle is in the low position.
6.	Put your transmitter into bind mode.
7.	After 5 to 10 seconds, the receiver status LED will become solid, indicating that the receiver is bound to the transmitter. If the LED does not turn solid, refer to the Troubleshooting Guide at the end of the manual.
For subsequent flights, power ON the transmitter for 5 seconds before connecting the flight battery.	

For a list of compatible DSM2/DSMX transmitters, please visit www.bindnfly.com.



CAUTION: When using a Futaba® transmitter with a Spektrum DSM module, you must reverse the throttle channel and rebind. Refer to your Spektrum module manual for binding and failsafe instructions. Refer to your Futaba transmitter manual for instructions on reversing the throttle channel.

Installing the Flight Battery and Arming the ESC

Arming the ESC also occurs after binding as previously described, but subsequent connection of a flight battery requires the following steps.

AS3X

The AS3X® system will not activate until the throttle stick or trim is increased for the first time. Once active, the control surfaces may move rapidly and noisily on the aircraft. This is normal. AS3X technology will remain active until the battery is disconnected.

It is normal for linear servos to make noise. Noise is not an indication of a faulty servo.

CAUTION: Always keep hands away from the propeller. When armed, the motor will turn the propeller in response to any throttle movement.

CAUTION: Always disconnect the Li-Po battery from the aircraft receiver when not flying to avoid over-discharging the battery. Batteries discharged to a voltage lower than the lowest approved voltage may become damaged, resulting in loss of performance and potential fire when batteries are charged.

1 Lower throttle and throttle trim to lowest settings.

Power ON the transmitter, then wait 5 seconds

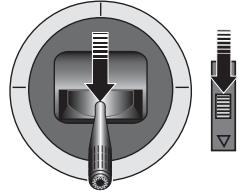

2 Connect the battery to the ESC, noting proper polarity.

Keep the plane immobile and away from wind for 5 seconds.

Continuous LED

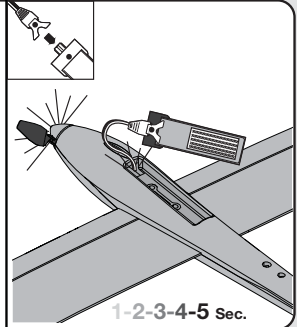

1-2-3-4-5 Sec.

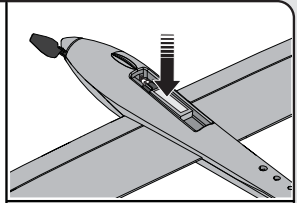

3 Secure the battery to the hook and loop strip on the battery holder.



FLY...

Control Direction Test

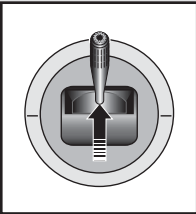
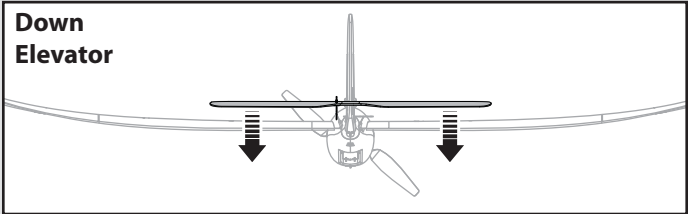
Move the controls on the transmitter to make sure the aircraft control surfaces move correctly. **Always keep throttle at the low position during testing.**

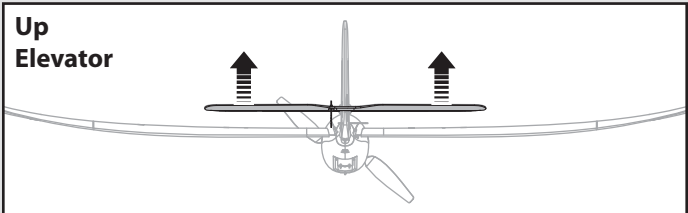
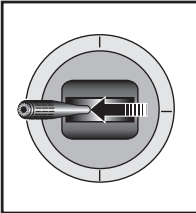
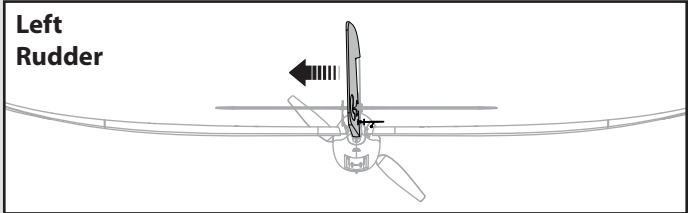
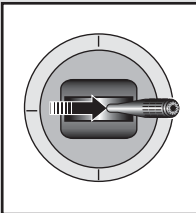
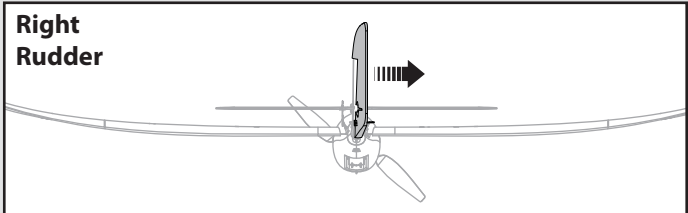
	Down Elevator 
	Up Elevator 
	Left Rudder 
	Right Rudder 

Control Centering

Before first flights, or in the event of a crash, make sure the control surfaces are centered when the transmitter controls and trims are neutral. The transmitter sub-trim must be set to zero. Adjust the linkages mechanically if the control surfaces are not centered.

For best performance with AS3X, it is important that excessive transmitter trim is not used.

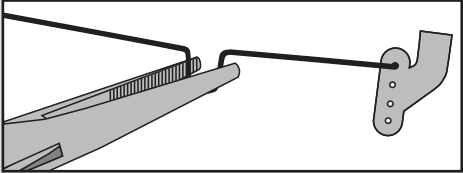

Control Horn Settings

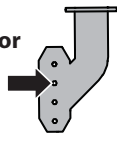
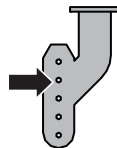
Elevator  Rudder 

Flying Tips

Consult local laws and ordinances before choosing a location to fly your aircraft.

We recommend flying your aircraft outside in no greater than moderate winds or inside in a large gymnasium. Always avoid flying near houses, trees, wires and buildings. You should also be careful to avoid flying in areas where there are many people, such as busy parks, schoolyards or soccer fields. For additional tips on flying, refer to the product page at horizonhobby.com.

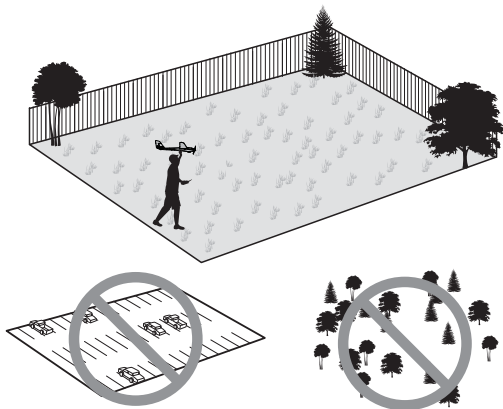

Hand Launching

When hand-launching your aircraft alone, hold the aircraft in one hand and the transmitter in the other.

Apply about 1/2–3/4 throttle. Hold the aircraft on the underside and throw the aircraft directly into the wind, angled slightly up (5 to 10 degrees above the horizon). Climb to check the trim. Once the trim is adjusted, begin exploring the flight envelope of the aircraft.

Soaring

Your aircraft can ascend on thermals and other updrafts to prolong its flight. There are many ways to stay aloft with a sailplane, such as ridge lifts and thermals. A thermal is simply a column of rising warm air. Once you get your aircraft into the air, watch your aircraft for a response to thermals. If the airplane randomly rolls on its own, it is likely that you only flew through the edge of the thermal, causing one side of the airplane to rise, rather than the entire airplane. Enter the thermal by turning your aircraft directly into it, circling to stay in the center of the thermal. Slow your forward speed by increasing up elevator trim so that your aircraft is moving just faster than stall (minimum sink speed). Make easy banking turns to find the area of highest lift (the thermal's core). When you find the core of lift, tighten your turns to stay near this position. Sometimes thermals

drift downwind. It is best that you search for thermals upwind, so that you can follow a thermal downwind if it is pushed downwind.

With practice, you will find it easier to locate and anticipate the movement of thermals. Although thermals cannot be seen, you can see dust, insects or birds riding an updraft. Air movement of a thermal may be felt, so movement in an otherwise calm spot may show you the location of a nearby thermal. A shift in the wind (in a light breeze) can be airflow into a thermal.

Landing

Make sure to land into the wind. Due to the high lifting efficiency of the sailplane design, landing requires a large landing area. While on your downwind leg, remember that the sailplane glides much better than other aircraft. You will need to setup for landing lower and with a more shallow descent than you may be used to. As you are on approach for landing, ensure that the model is descending slowly, but also not accelerating. Maintain this descent and speed, and, as the model nears the ground (approximately 6 inches (15 cm)), slowly apply a small amount of up elevator. Before the aircraft touches down, always fully decrease throttle to avoid damage to the propeller, motor, ESC or other components.

CAUTION: Never catch a flying aircraft in your hands. Doing so could cause personal injury and damage to the aircraft.

Failure to lower the throttle stick and trim to the lowest possible positions during a crash could result in damage to the ESC in the receiver unit, which may require replacement.

NOTICE: Crash damage is not covered under warranty.

NOTICE: Always decrease throttle at propeller strike.



Flying Tips continued

Low Voltage Cutoff (LVC)

Low Voltage Cutoff (LVC) pulses the power to the motor when the voltage gets low. When the motor power pulses, land the aircraft immediately and recharge the flight battery.

Disconnect and remove the Li-Po battery from the aircraft after use to prevent trickle discharge. Fully charge your Li-Po battery before storing it. During storage, make sure the battery charge does not fall below 3V per cell.

LVC does not prevent the battery from over-discharge during storage.

NOTICE: Repeated flying to LVC will damage the battery.

NOTICE: When finished flying, never keep the aircraft in the sun. Do not store the aircraft in a hot, enclosed area such as a car. Doing so can damage the foam.

Repairs

Repair the aircraft using foam-compatible CA glue (Cyanoacrylate adhesive) or clear tape. Only use foam-compatible CA glue, as other types of glue can damage the foam. When parts are not repairable, or for a list of all replacement and optional parts, refer to the list at the back of this manual.

NOTICE: Use of foam-compatible CA accelerant on your aircraft can damage paint. DO NOT handle the aircraft until accelerant fully dries.

Post Flight Checklist

✓	
1.	Disconnect the flight battery from the ESC (required for safety and battery life).
2.	Power OFF the transmitter.
3.	Remove the flight battery from the aircraft.

✓	
4.	Recharge the flight battery.
5.	Store the flight battery apart from the aircraft and monitor the battery charge.
6.	Make note of the flight conditions and flight plan results, planning for future flights.

Motor Service

CAUTION: DO NOT handle propeller parts while the flight battery is connected. Personal injury could result.

IMPORTANT: Removing tape or decals can remove paint from the fuselage.

NOTICE: DO NOT remove the gearbox from the aircraft. Damage to the aircraft will result.

- Hold the prop shaft using needle-nose pliers or hemostats to remove the propeller and prop nut.

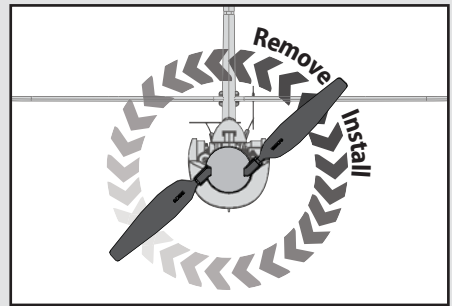
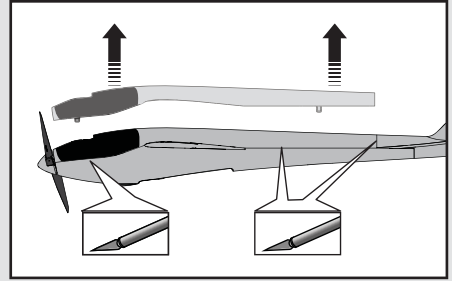

Assembly

Assemble in reverse order.

- Correctly align the prop shaft gear with the pinion gear on the motor.
- Connect the motor to the ESC/receiver so that the powered motor turns the propeller counterclockwise (facing the front of the model).
- Make sure the propeller size numbers (130x70) face away from the motor (see illustration).
- Attach the spinner to the propeller using foam-compatible CA (Cyanoacrylate adhesive).
- Assemble the fuselage using clear tape.

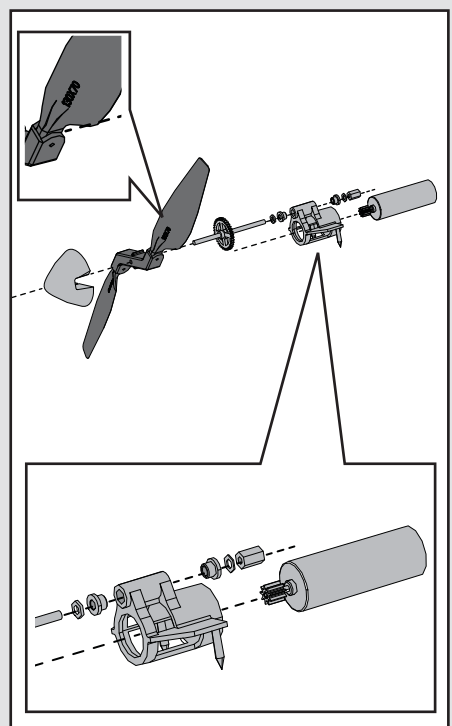

Troubleshooting Guide

AS3X

Problem	Possible Cause	Solution
Control surfaces not at neutral position when transmitter controls are at neutral	Control surfaces may not have been mechanically centered from factory	Center control surfaces mechanically by adjusting the U-bends on control linkages
	Aircraft was moved after the flight battery was connected and before sensors initialized	Disconnect and reconnect the flight battery while keeping the aircraft still for 5 seconds
Model flies inconsistently from flight to flight	Trims are moved too far from neutral position	Neutralize trims and mechanically adjust linkages to center control surfaces
Controls oscillate in flight, (model rapidly jumps or moves)	Propeller is unbalanced, causing excessive vibration	Remove propeller and rebalance or replace it if damaged
	Nut on prop shaft is too loose, causing excessive vibration	Tighten the prop shaft nut 1/2 turn

Problem	Possible Cause	Solution
Aircraft will not respond to throttle but responds to other controls	Throttle stick and/or throttle trim is too high	Reset controls with throttle stick and throttle trim at lowest setting
	Throttle channel is reversed	Reverse throttle channel on transmitter
	Motor is disconnected from receiver	Open fuselage and ensure the plug for the motor is properly installed
Extra propeller noise or extra vibration	Damaged propeller, prop shaft or motor	Replace damaged parts
	Nut on prop shaft is too loose	Tighten the prop shaft nut 1/2 turn
Reduced flight time or aircraft underpowered	Flight battery charge is low	Completely recharge flight battery
	Propeller is installed backwards	Install propeller with numbers facing forward
	Flight battery is damaged	Replace flight battery and follow flight battery instructions
	Flight conditions may be too cold	Make sure battery is warm before use
	Battery capacity is too low for flight conditions	Replace battery or use a larger capacity battery

Troubleshooting Guide (continued)

Problem	Possible Cause	Solution
LED on receiver flashes rapidly and aircraft will not bind to transmitter (during binding)	Transmitter is too near aircraft during binding process	Power off transmitter, move transmitter a larger distance from aircraft, disconnect and reconnect flight battery to aircraft and follow binding instructions
	Bind switch or button was not held while transmitter was powered on	Power off transmitter and repeat bind process
	Aircraft or transmitter is too close to large metal object, wireless source or another transmitter	Move aircraft and transmitter to another location and attempt binding again
LED on receiver flashes rapidly and aircraft will not respond to transmitter (after binding)	Less than a 5-second wait between first powering on transmitter and connecting flight battery to aircraft	Leaving transmitter on, disconnect and reconnect flight battery to aircraft
	Aircraft is bound to a different model memory (ModelMatch™ radios only)	Select correct model memory on transmitter and disconnect and reconnect flight battery to aircraft
	Flight battery/transmitter battery charge is too low	Replace/recharge batteries
	Transmitter may have been bound to a different model (or with a different DSM Protocol)	Select the right transmitter or bind to the new one
	Aircraft or transmitter is too close to large metal object, wireless source or another transmitter	Move aircraft and transmitter to another location and attempt connecting again
Control surface does not move	Control surface, control horn, linkage or servo damage	Replace or repair damaged parts and adjust controls
	Wire damaged or connections loose	Do a check of wires and connections; connect or replace as needed
	Flight battery charge is low	Fully recharge flight battery
	Control linkage does not move freely	Make sure control linkage moves freely
Controls reversed	Transmitter settings reversed	Do the Control Direction Test and adjust controls on transmitter appropriately
Motor loses power	Damage to motor or power components	Do a check of motor and power components for damage (replace as needed)
	Nut on prop shaft is too tight	Loosen prop shaft nut until propeller shaft turns freely
Motor power quickly decreases and increases then motor loses power	Battery power is down to the point of receiver/ESC Low Voltage Cutoff (LVC)	Recharge flight battery or replace battery that is no longer performing
Servo locks or freezes at full travel	Travel adjust value is set above 100% overdriving the servo	Set Travel adjust to 100% or less and/or set sub trims to Zero and adjust linkages mechanically.

Limited Warranty

What this Warranty Covers

Horizon Hobby, Inc. ("Horizon") warrants to the original purchaser that the product purchased (the "Product") will be free from defects in materials and workmanship at the date of purchase.

What is Not Covered

This warranty is not transferable and does not cover (i) cosmetic damage, (ii) damage due to acts of God, accident, misuse, abuse, negligence, commercial use, or due to improper use, installation, operation or maintenance, (iii) modification of or to any part of the Product, (iv) attempted service by anyone other than a Horizon Hobby authorized service center, (v) Product not purchased from an authorized Horizon dealer, or (vi) Product not compliant with applicable technical regulations.

OTHER THAN THE EXPRESS WARRANTY ABOVE, HORIZON MAKES NO OTHER WARRANTY OR REPRESENTATION, AND HEREBY DISCLAIMS ANY AND ALL IMPLIED WARRANTIES, INCLUDING, WITHOUT LIMITATION, THE IMPLIED WARRANTIES OF NON-INFRINGEMENT, MERCHANTABILITY AND FITNESS FOR A PARTICULAR PURPOSE. THE PURCHASER ACKNOWLEDGES THAT THEY ALONE HAVE DETERMINED THAT THE PRODUCT WILL SUITABLY MEET THE REQUIREMENTS OF THE PURCHASER'S INTENDED USE.

Purchaser's Remedy

Horizon's sole obligation and purchaser's sole and exclusive remedy shall be that Horizon will, at its option, either (i) service, or (ii) replace, any Product determined by Horizon to be defective. Horizon reserves the right to inspect any and all Product(s) involved in a warranty claim. Service or replacement decisions are at the sole discretion of Horizon. Proof of purchase is required for all warranty claims. SERVICE OR REPLACEMENT AS PROVIDED UNDER THIS WARRANTY IS THE PURCHASER'S SOLE AND EXCLUSIVE REMEDY.

Limitation of Liability

HORIZON SHALL NOT BE LIABLE FOR SPECIAL, INDIRECT, INCIDENTAL OR CONSEQUENTIAL DAMAGES, LOSS OF PROFITS OR PRODUCTION OR COMMERCIAL LOSS IN ANY WAY, REGARDLESS OF WHETHER SUCH CLAIM IS BASED IN CONTRACT, WARRANTY, TORT, NEGLIGENCE, STRICT LIABILITY OR ANY OTHER THEORY OF LIABILITY, EVEN IF HORIZON HAS BEEN ADVISED OF THE POSSIBILITY OF SUCH DAMAGES. Further, in no event shall the liability of Horizon exceed the individual price of the Product on which liability is asserted. As Horizon has no control over use, setup, final assembly, modification or misuse, no liability shall be assumed nor accepted for any resulting damage or injury. By the act of use, setup or assembly, the user accepts all resulting liability.

If you as the purchaser or user are not prepared to accept the liability associated with the use of the Product, purchaser is advised to return the Product immediately in new and unused condition to the place of purchase.

Law

These terms are governed by Illinois law (without regard to conflict of law principals). This warranty gives you specific legal rights, and you may also have other rights which vary from state to state. Horizon reserves the right to change or modify this warranty at any time without notice.

WARRANTY SERVICES

Questions, Assistance, and Services

Your local hobby store and/or place of purchase cannot provide warranty support or service. Once assembly, setup or use of the Product has been started, you must contact your local distributor or Horizon directly. This will enable Horizon to better answer your questions and service you in the event that you may need any assistance. For questions or assistance, please visit our website at www.horizonhobby.com, submit a Product Support Inquiry, or call the toll free telephone number referenced in the Warranty and Service Contact Information section to speak with a Product Support representative.

Inspection or Services

If this Product needs to be inspected or serviced and is compliant in the country you live and use the Product in, please use the Horizon Online Service Request submission process found on our website or call Horizon to obtain a Return Merchandise Authorization (RMA) number. Pack the Product securely using a shipping carton. Please note that original boxes may be included, but are not designed to withstand the rigors of shipping without additional protection. Ship via a carrier that provides tracking and insurance for lost or damaged parcels, as Horizon is not responsible for merchandise until it arrives and is accepted at our facility. An Online Service Request is available at http://www.horizonhobby.com/content/_service-center_render-service-center. If you do not have internet access, please contact Horizon Product Support to obtain a RMA number along with instructions for submitting your product for service. When calling Horizon, you will be asked to provide your complete name, street address, email address and phone number where you can be reached during business hours. When sending product into Horizon, please include your RMA number, a list of the included items, and a brief summary of the problem. A copy of your original sales receipt must be included for warranty consideration. Be sure your name, address, and RMA number are clearly written on

the outside of the shipping carton.

NOTICE: Do not ship LiPo batteries to Horizon. If you have any issue with a LiPo battery, please contact the appropriate Horizon Product Support office.

Warranty Requirements

For Warranty consideration, you must include your original sales receipt verifying the proof-of-purchase date. Provided warranty conditions have been met, your Product will be serviced or replaced free of charge. Service or replacement decisions are at the sole discretion of Horizon.

Non-Warranty Service

Should your service not be covered by warranty, service will be completed and payment will be required without notification or estimate of the expense unless the expense exceeds 50% of the retail purchase cost. By submitting the item for service you are agreeing to payment of the service without notification.

Service estimates are available upon request. You must include this request with your item submitted for service. Non-warranty service estimates will be billed a minimum of ½ hour of labor. In addition you will be billed for return freight. Horizon accepts money orders and cashier's checks, as well as Visa, MasterCard, American Express, and Discover cards. By submitting any item to Horizon for service, you are agreeing to Horizon's Terms and Conditions found on our website http://www.horizonhobby.com/content/_service-center_render-service-center.

ATTENTION: Horizon service is limited to Product compliant in the country of use and ownership. If received, a non-compliant Product will not be serviced. Further, the sender will be responsible for arranging return shipment of the un-serviced Product, through a carrier of the sender's choice and at the sender's expense. Horizon will hold non-compliant Product for a period of 60 days from notification, after which it will be discarded.

Warranty and Service Information

Country of Purchase	Horizon Hobby	Phone Number/Email Address	Address
United States of America	Horizon Service Center (Repairs and Repair Requests)	servicecenter.horizonhobby.com/RequestForm/	4105 Fieldstone Rd Champaign, Illinois, 61822 USA
	Horizon Product Support (Product Technical Assistance)	www.quickbase.com/db/bghj7ey8c?a=GenNewRecord 888-959-2305	
	Sales	sales@horizonhobby.com 888-959-2305	
United Kingdom	Service/Parts/Sales: Horizon Hobby Limited	sales@horizonhobby.co.uk +44 (0) 1279 641 097	Units 1-4 Ployters Rd Staple Tye Harlow, Essex CM18 7NS, United Kingdom
Germany	Horizon Technischer Service Sales: Horizon Hobby GmbH	+49 (0) 4121 2655 100 service@horizonhobby.de	Christian-Junge-Straße 1 25337 Elmshorn, Germany
France	Service/Parts/Sales: Horizon Hobby SAS	infofrance@horizonhobby.com +33 (0) 1 60 18 34 90	11 Rue Georges Charpak 77127 Lieusaint
China	Service/Parts/Sales: Horizon Hobby – China	info@horizonhobby.com.cn +86 (021) 5180 9868	Room 506, No. 97 Changshou Rd. Shanghai, China, 200060

FCC Information

This device complies with part 15 of the FCC rules. Operation is subject to the following two conditions: (1) This device may not cause harmful interference, and (2) this device must accept any interference received, including interference that may cause undesired operation.

CAUTION: Changes or modifications not expressly approved by the party responsible for compliance could void the user's authority to operate the equipment.

This product contains a radio transmitter with wireless technology which has been tested and found to be compliant with the applicable regulations governing a radio transmitter in the 2.400GHz to 2.4835GHz frequency range.

Compliance Information for the European Union

Declaration of Conformity

(in accordance with ISO/IEC 17050-1)
No. HH2014010402

Product(s): EFL UMX Radian BNF
Item Number(s): EFLU2980
Equipment class: 1

The object of declaration described above is in conformity with the requirements of the specifications listed below, following the provisions of the European R&TTE directive 1999/5/EC, EMC Directive 2004/108/EC and LVD Directive 2006/95/EC

EN 301 489-1 V1.9.2: 2012
EN 301 489-17 V2.1.1: 2009

EN60950-1:2006+A11:2009+A1:2010+A12: 2011

EN55022:2010 + AC:2011
EN55024: 2010



Signed for and on behalf of:
Horizon Hobby, Inc.
Champaign, IL USA
Jan 4, 2014

A handwritten signature in black ink, appearing to read 'Robert Peak', written in a cursive style.

Robert Peak
Chief Financial Officer
Horizon Hobby, Inc.

Instructions for disposal of WEEE by users in the European Union



This product must not be disposed of with other waste. Instead, it is the user's responsibility to dispose of their waste equipment by handing it over to a designated collection point for the recycling of waste electrical and electronic equipment. The separate collection and recycling of your waste equipment at the time of disposal will help to conserve natural resources and ensure that it is recycled in a manner that protects human health and the environment. For more information about where you can drop off your waste equipment for recycling, please contact your local city office, your household waste disposal service or where you purchased the product.

Replacement Parts • Ersatzteile • Pièces de rechange • Pezzi di ricambio

Part # • Nummer Numéro • Codice	Description	Beschreibung	Description	Descrizione
EFLU2903	Spinner Set (3): Ultra Micro Radian	Ultra Micro Radian: Spinner Set	Jeu de cônes (3) : Ultra Micro Radian	Set ogiva (3): Ultra Micro Radian
EFLU2901	Decal Sheet: Ultra Micro Radian	E-flite Ultra Micro Radian: Dekorbogen	Planche de décalcomanies : Ultra Micro Radian	Foglio con decalcomanie: Ultra Micro Radian
EFLU2902	Folding Propeller: Ultra Micro Radian	E-flite Ultra Micro Radian Klapp- Propeller	Hélice repliable : Ultra Micro Radian	Elica ripiegabile: Ultra Micro Radian
EFLU2920	Main Wing: Ultra Micro Radian	Ultra Micro Radian: Tragfläche	Aile : Ultra Micro Radian	Ala Principale: Ultra Micro Radian
EFLU2925	Tail Set: Ultra Micro Radian	E-flite Ultra Micro Radian: Leitwerk	Empennages : Ultra Micro Radian	Set coda: Ultra Micro Radian
EFLU2967	Fuselage: Ultra Micro Radian	E-flite Ultra Micro Radian: Rumpf	Fuselage : Ultra Micro Radian	Fusoliera: Ultra Micro Radian
EFLU2922	Pushrod Set: Ultra Micro Radian	Ultra Micro Radian: Schubstangensatz	Jeu tringleries : Ultra Micro Radian	Set asta di spinta: Ultra Micro Radian
EFLB1501S25	1S 3.7V 25C 150mAh Li-Po Battery	1S-3,7V-25C 150mAh-Li-Po-Akku	Batterie Li-Po 150 mAh 25C 3,7V 1S	Batteria Li-Po 1S da 3,7V, 25C 150 mAh
SPMAR5430L	5-CH Replacement AS3X Receiver: UM Radian	E-flite UM Radian 5 Kanal Ersatz AS3X Empfänger	Récepteur 5 voies de remplacement avec technologie AS3X : UM Radian	Ricevente a 5-CH con Sistema AS3X: UM Radian
EFLU2916	Motor: Ultra Micro Radian	E-flite Motor : Micro Radian	Moteur : Ultra Micro Radian	Motore Ultra Micro Radian
EFLU2927	Gearbox: Ultra Micro Radian	E-flite Getriebe : Ultra Micro Radian	Réducteur : Ultra Micro Radian	Riduttore: Ultra Micro Radian
EFL9054	Prop Shaft with gear (2) : Sukhoi Su-26m, Micro P-51	E-flite Ultra Micro 4-Site Luftschrauben- welle mit Getriebe	Arbre d'hélice avec réducteur (2) : Sukhoi Su-26m, Micro P-51	Albero dell'elica con ingranaggio (2): Sukhoi Su-26m, Micro P-51

Optional Parts and Accessories • Optionale Bauteile und Zubehör • Pièces et accessoires optionnels • Componenti e accessori opzionali

Part # Nummer Numéro Codice	Description	Beschreibung	Description	Descrizione
EFLC1000	AC/DC 3.7V Li-Po Charger	AC/DC-3,7V-Li-Po-Ladegerät	Chargeur Li-Po CA/DC 3,7V	Caricabatterie Li-Po CA/CC da 3,7V
EFLC1004	Celectra 4-Port 1S 3.7V 0.3 A DC Li-Po Charger	E-flite 4 Port Ladegerät 1S 3,7V 0,3A	Chargeur Li-Po CC 0,3 A 3,7V 1S 4 ports Celectra	Caricabatterie Li-Po 1S da 3,7V 0,3 A CC, a 4 porte, Celectra
EFLB1501S45	150mAh 1S 3.7V 45C Li-Po Battery	1S 3.7V 150mAh 45C Li-Po Akku	Batterie Li-Po 3.7V 1S 150mA 45C	1S 3.7V 150mAh 45C Li-Po Batteria
EFLC1005/ AU/EU/UK	AC to 6V DC 1.5 amp Power Supply (Based upon your sales Region)	E-flite Netzteil für 4 Port Ladegerät	Alimentation CA vers 6V CC, 1,5 A (En fonction de votre région)	Alimentatore da CA a 6 V CC, 1,5 Amp (in base al Paese di vendita)
	DX4e DSMX 4-channel Transmitter	Spektrum DX4e DSMX 4 Kanalsender ohne Empfänger	Emetteur DX4e DSMX 4 voies	DX4e DSMX Trasmittitore 4 canali
	DX5e DSMX 5-channel Transmitter	Spektrum DX5e DSMX 5 Kanalsender ohne Empfänger	Emetteur DX5e DSMX 5 voies	DX5e DSMX Trasmittitore 5 canali
	DX6i DSMX 6-Channel Transmitter	DX6i DSMX 6-Kanal Sender	Emetteur DX6i DSMX 6 voies	DX6i DSMX Trasmittitore 6 canali
	DX7s DSMX 7-Channel Transmitter	Spektrum DX7s 7 Kanal Sender	Emetteur DX7s DSMX 7 voies	DX7s DSMX Trasmittitore 7 canali
	DX8 DSMX Transmitter	Spektrum DX8 nur Sender	Emetteur DX8 DSMX 8 voies	DX8 DSMX Solo trasmittitore

Parts Contact Information • Kontaktinformationen für Ersatzteile • Coordonnées (pièces) • Recapiti dei distributori

Country of Purchase	Horizon Hobby	Address	Phone Number/ Email Address
United States	Sales	4105 Fieldstone Rd Champaign, Illinois, 61822 USA	800-338-4639 sales@horizonhobby.com
United Kingdom	Horizon Hobby Limited	Units 1-4 Ployters Rd Staple Tye Harlow, Essex CM18 7NS, United Kingdom	+44 (0) 1279 641 097 sales@horizonhobby.co.uk
Germany	Horizon Hobby GmbH	Christian-Junge-Straße 1 25337 Elmshorn, Germany	+49 (0) 4121 2655 100 service@horizonhobby.de
France	Horizon Hobby SAS	11 Rue Georges Charpak 77127 Lieusaint, France	+33 (0) 1 60 18 34 90 infofrance@horizonhobby.com
China	Horizon Hobby – China	Room 506, No. 97 Changshou Rd. Shanghai, China, 200060	+86 (021) 5180 9868 info@horizonhobby.com.cn

© 2013 Horizon Hobby, Inc.

E-flite, Radian, AS3X, Blade, Celectra, UMX, DSM, DSM2, DSMX, ModelMatch, Bind-N-Fly, the Bind-N-Fly logo and the Horizon Hobby logo are trademarks or registered trademarks of Horizon Hobby, Inc.

The Spektrum trademark is used with permission of Bachmann Industries, Inc.

Futaba is a registered trademark of Futaba Denshi Kogyo Kabushiki Kaisha Corporation of Japan.

All other trademarks, service marks and logos are property of their respective owners.

US D578, 146. US 7,898,130. PRC ZL 200720069025.2. PRC ZL 2007001249. Patents pending.

www.e-fliterc.com

