



Perfect Appearance Excellent Performance

1450 MM P-51B Mustang

OPERATING MANUAL



<http://www.facebook.com/FMSmodel>



www.fmsmodel.com

Please visit both our Facebook fanpage and our homepage for updated product information

WARNING

 **WARNING:** Read the ENTIRE instruction manual to become familiar with the features of the product before operating. Failure to operate the product correctly can result in damage to the product, personal property and cause serious injury.

This is a sophisticated hobby product and NOT a toy. It must be operated with caution and common sense and requires some basic mechanical ability. Failure to operate this Product in a safe and responsible manner could result in injury or damage to the product or other property. This product is not intended for use by children without direct adult supervision.

This manual contains instructions for safety, operation and maintenance. It is essential to read and follow all the instructions and warnings in manual, prior to assembly, setup or use, in order to operate correctly and avoid damage or serious injury.

Safety Precautions and Warnings

As the user of this product, you are solely responsible for operating in a manner that does not endanger yourself and others or result in damage to the product or the property of others. This model is controlled by a radio signal subject to interference from many sources outside your control. This interference can cause momentary loss of control so it is advisable to always keep a safe distance in all directions around your model, as this margin will help avoid collisions or injury.

Age Recommendation: Not for children under 14 years. This is not a toy.

- Never operate your model with low transmitter batteries.
- Always operate your model in an open area away from cars, traffic or people.
- Avoid operating your model in the street where injury or damage can occur.
- Never operate the model in the street or in populated areas for any reason.
- Carefully follow the directions and warnings for this and any optional support equipment (chargers, rechargeable battery packs, etc.) you use.
- Keep all chemicals, small parts and anything electrical out of the reach of children.
- Moisture causes damage to electronics. Avoid water exposure to all equipment not specifically designed and protected for this purpose.
- Never lick or place any portion of your model in your mouth as it could cause serious injury or even death.

FMS Kindly Reminder



Thank you for purchasing a FMS model product. Our goal is to provide high quality products and offer great customer service. If you have any problems with your product or want to offer suggestions for improvements (such as plane design, packaging, building instructions, etc.) please feel free to contact us at info@fmsmodel.com

The control horn installation

1. The control surface horns for the rudder and elevator are stapled to the bags containing the rudder and elevator, do not accidentally discard them.

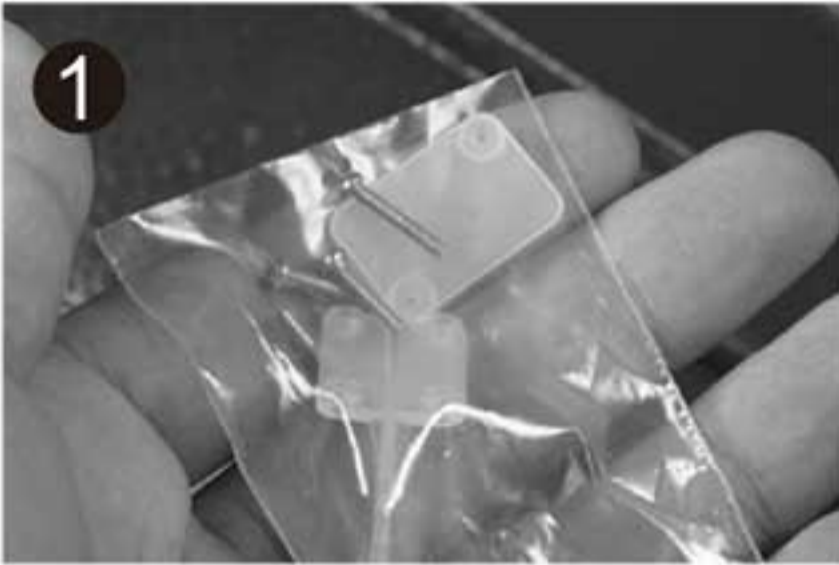

2. Install the elevator control surface horns on the bottom of the elevator surface with the screws provided in the small plastic bag. The side of the stabilizer that contains the nose faces down, make sure to install the control horns on this side. Make sure the control surface horns are facing into the right direction before installing.

Note: The longer screws always located on the leading edge side of all the control surface.

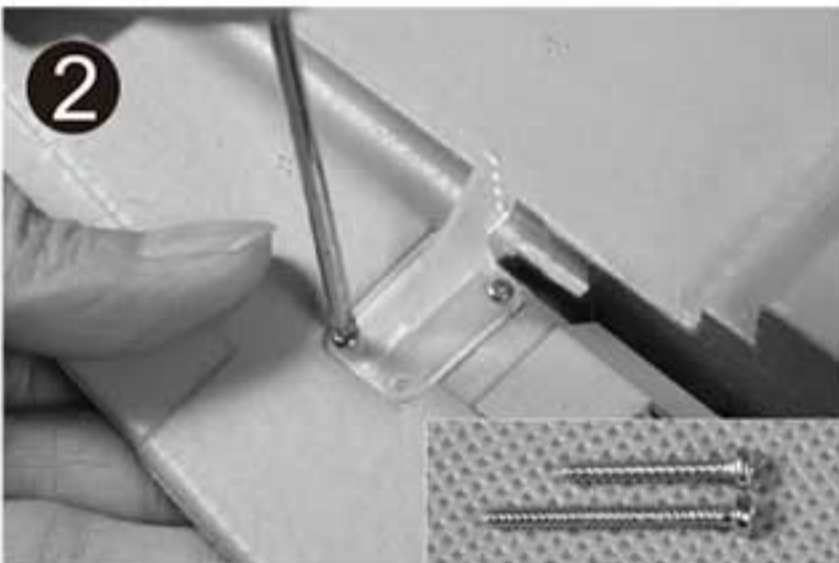

3. Always make sure that the screws are grabbing into the back plates of the control horns. It is very important that these parts are holding tight during flight.



4. Attach the rudder surface control horn to the port side of the rudder.



5. The aileron accessories part are include in the bag with the label "Aileron".



The control horn installation

6. Now attach the aileron surface control horns to the bottom of the lower main wing.

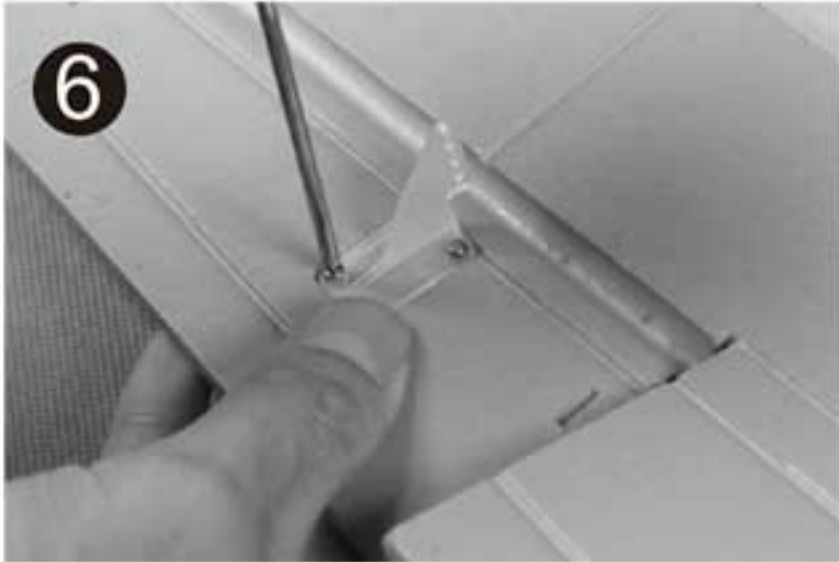

7. Attach the flaps control horn the same with the aileron .

**One piece main wing building**

1. Insert the in stored fiberglass tube into the main wing trailing edge side socket on the main wing root.

Note: When sliding the tubes into the wings, they should go in easily.

Do not push them farther than they will go with little resistance.

That would push the wing tubes into the foam of the wing and prevent them from fully inserting into the opposite wing half. Insert the connecting tube till the white mark the factory pre spackled.

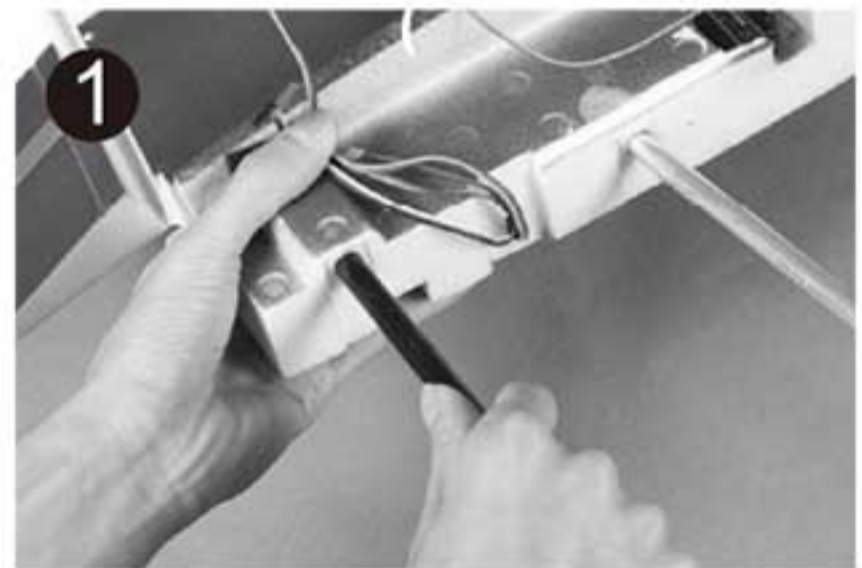

2. Insert the in stored pre bended Aluminum tube into the main wing leading edge side socket till the bend point.

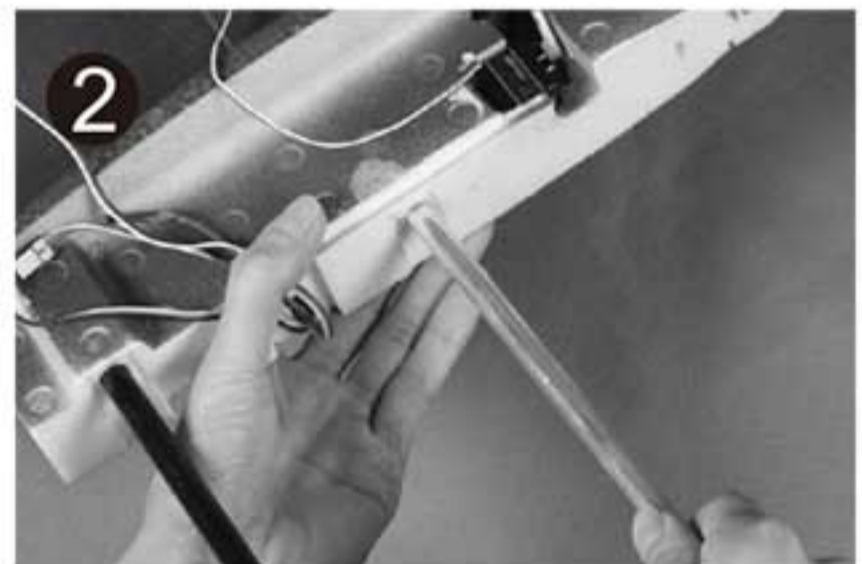

step2-3

One piece main wing building

3. The two rods are parallel from the top view.
Note: The bended angle of the aluminum rod consistent with the main wing dihedral.

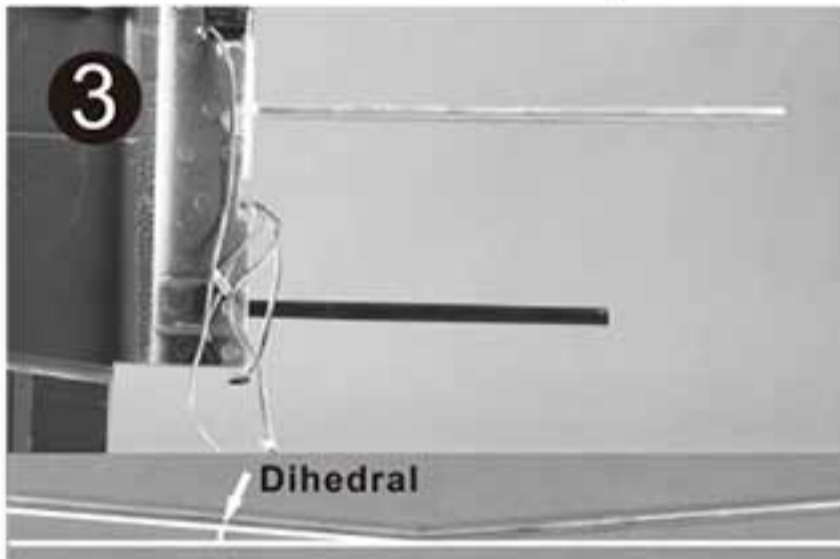

4. Connect the rest half wing to the rods, slide it in slightly. Make sure there is no slot between this two main wing panels. If not, you have to check the obstruction out.

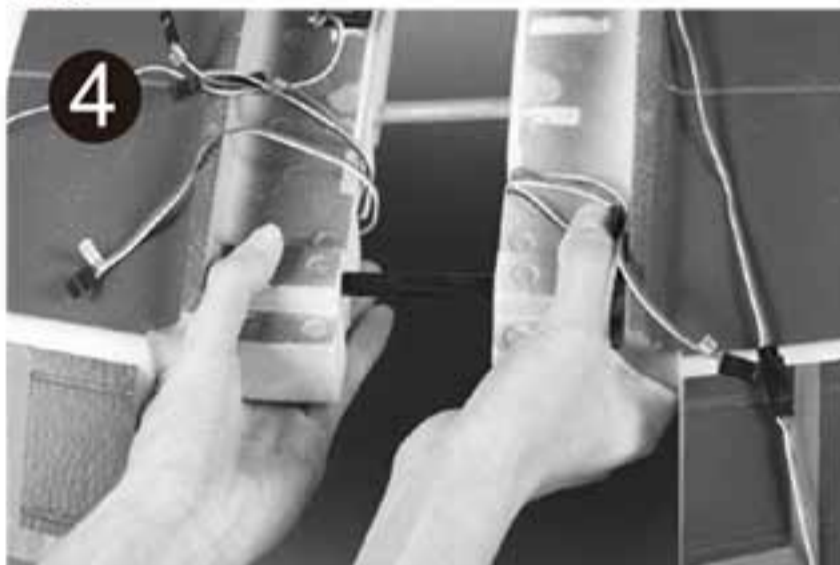

5. Make sure all of the leads running through the square hole between the main wing to the top of the main wing to avoid them to protect the wing halves from the fully contact to each other.

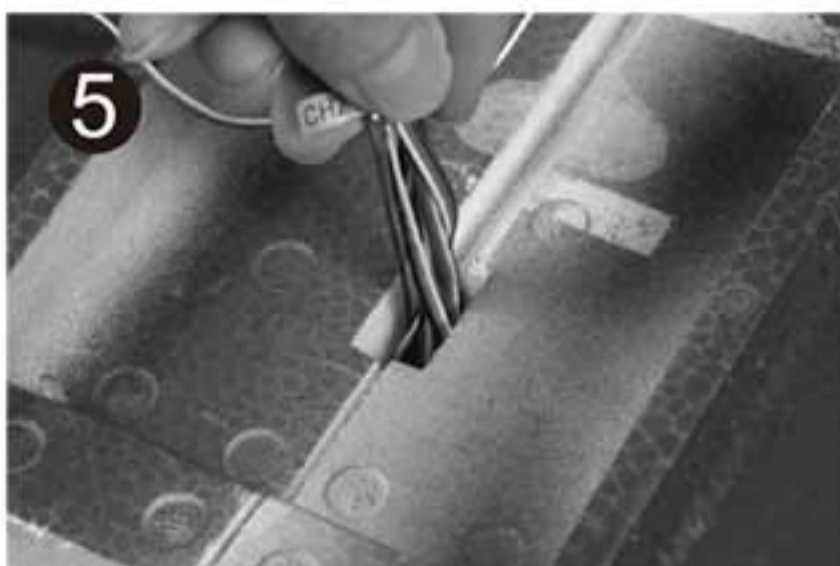

Test the main wing electric device

1. Before getting started, bind your receiver with your transmitter. Please refer to your **Transmitter Manual** for proper operation. **CAUTION:** To prevent personal injury, DO NOT install the propeller assembly onto the motor shaft while binding the receiver to your transmitter.
2. Connect the wing leads to the harness the first. Two ailerons servo to the Y harness labeled **AILE**, main landing gears and the fairing door servos to the sequencer, two LED leads to the triple harness labeled **CH2**.

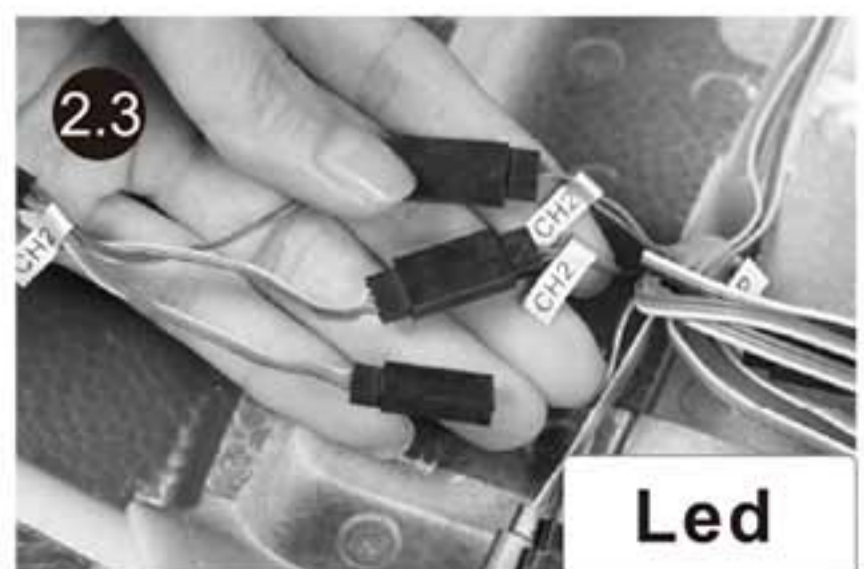
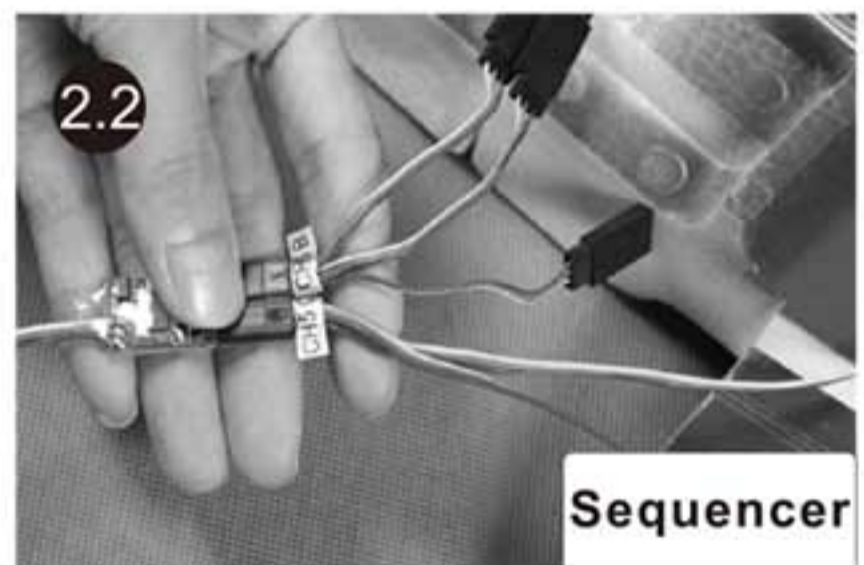

Test the main wing electric device

3. The receiver connection

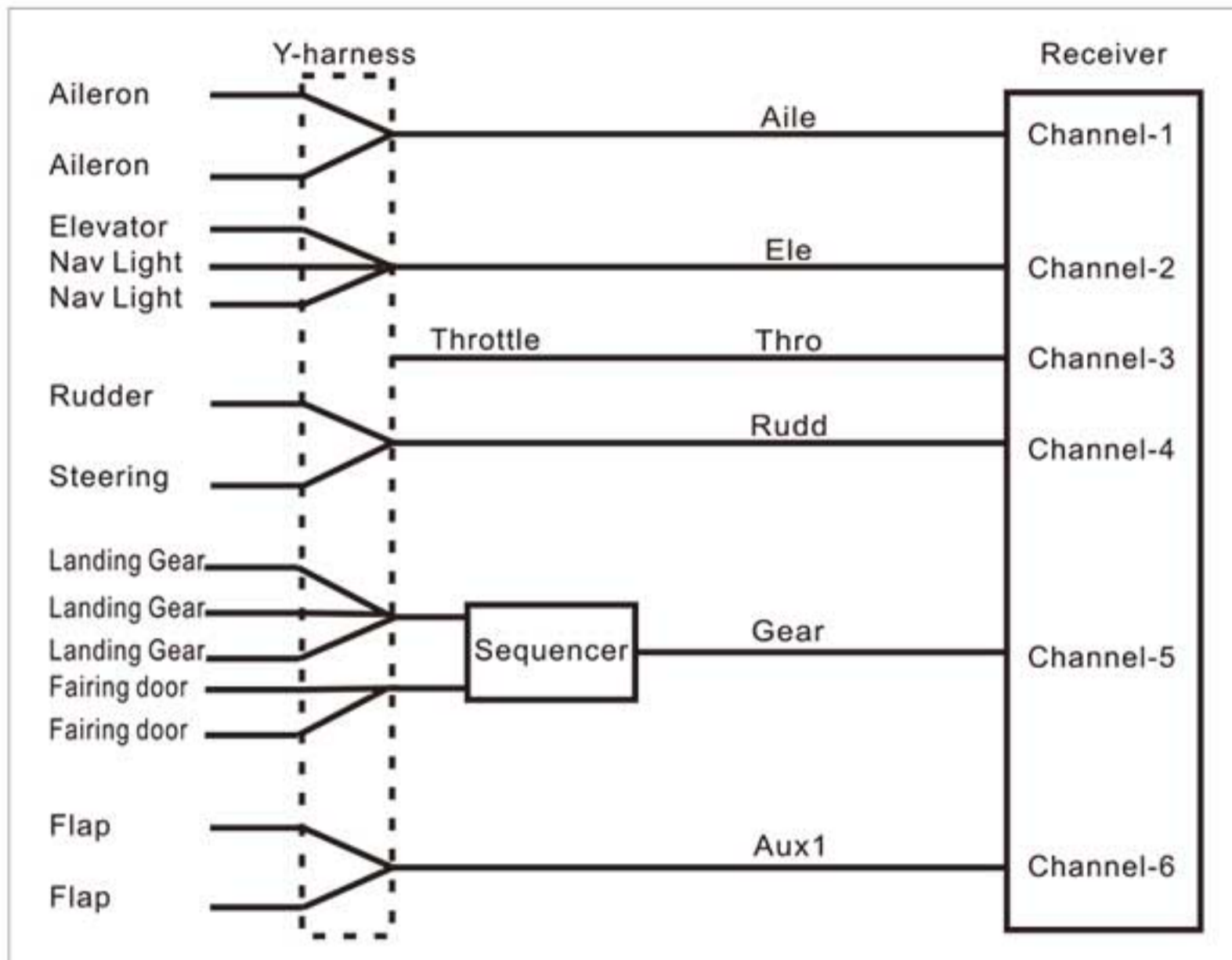

4. Diagram for the sequencer connection.

Note: With the chip side of the sequencer face up. Ch5 B for the retracts Ch5 C for fairing door driving servos. The signal wire of the leads (The orange wires) on the same side.

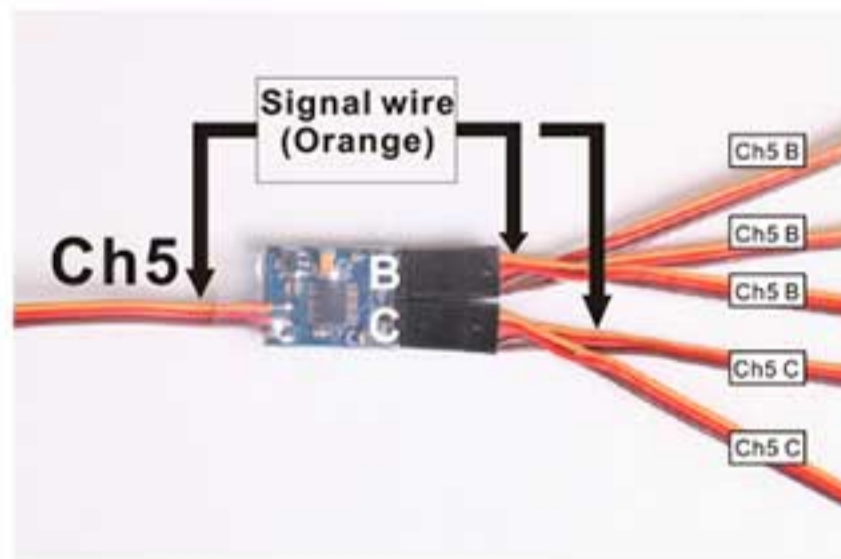

Note: All servo and retract leads have been specifically labeled for your convenience. Use the provided Y-harness for situations where two or three servos are controlled by one channel; for example ailerons, landing gear, and flaps. Refer to the diagram above for recommended connections.

Test the main wing electric device

5. Make sure the main landing gears and the faring doors work well in order, if not, you have to check that if the lead goes into the right port on the sequencer.

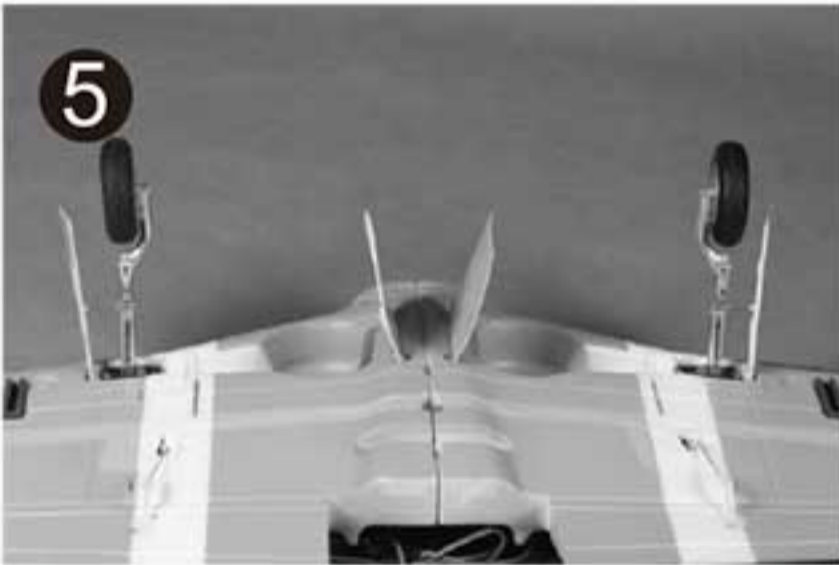

6. Make sure the navigation light on port side(L) wing tip emitting red beams, the starboard(R) is green.

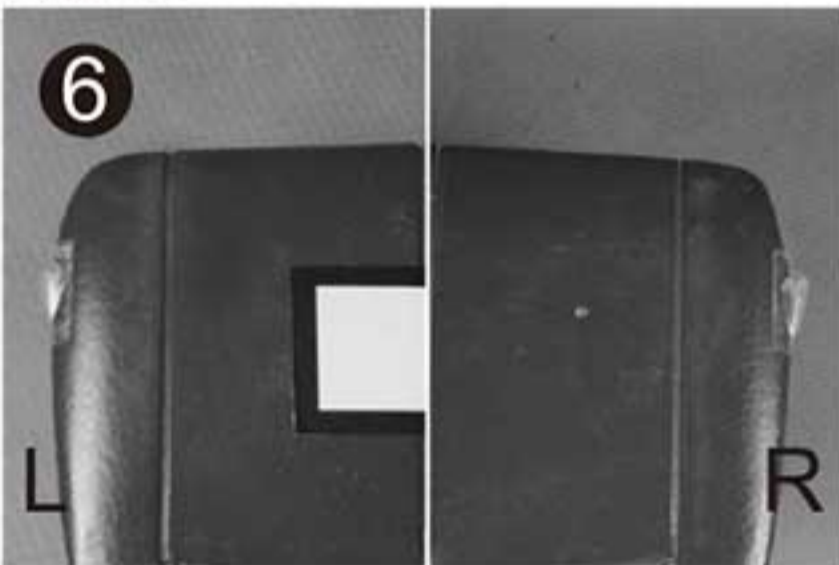

7. Stick Input the aileron to make sure the servos functions well. Put the Z-bend end of the linkage into the desired servo control horn hole of the main-wing. It is a tight fit and should allow the linkage to move just slightly within the hole to avoid binding up.

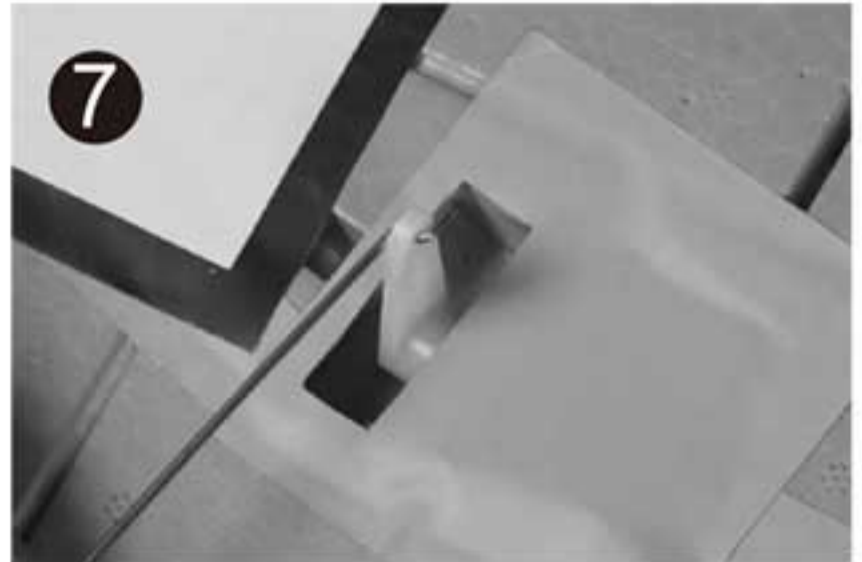

8. Slap the clevis into the surface control horn.

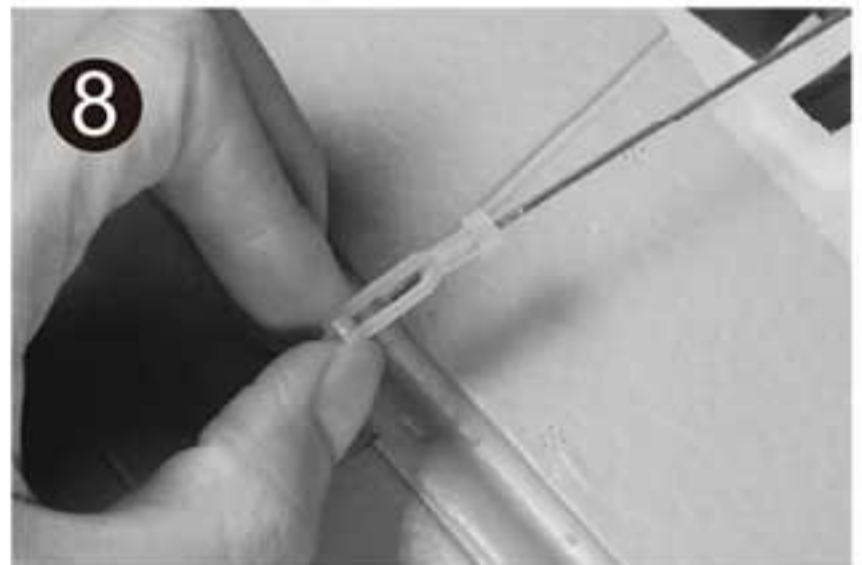

9. The provided piece of fuel tubing keeps the clevis closed during flight. Do all the linkages the same way in the model building process.



Test the main wing electric device

10. Toggle switch the flaps channel knob according to which port the Y harness you have inserted into the receiver.

Note: To avoid the "buzz" sound from the flap servos, install either the flaps linkage while the servo arm in up position. And make sure the trailing edge of the flaps level with the wing root.

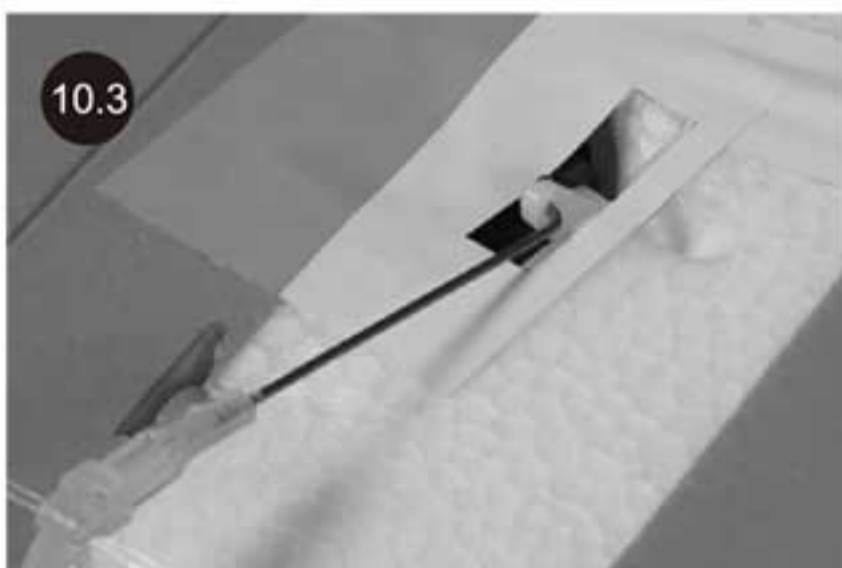
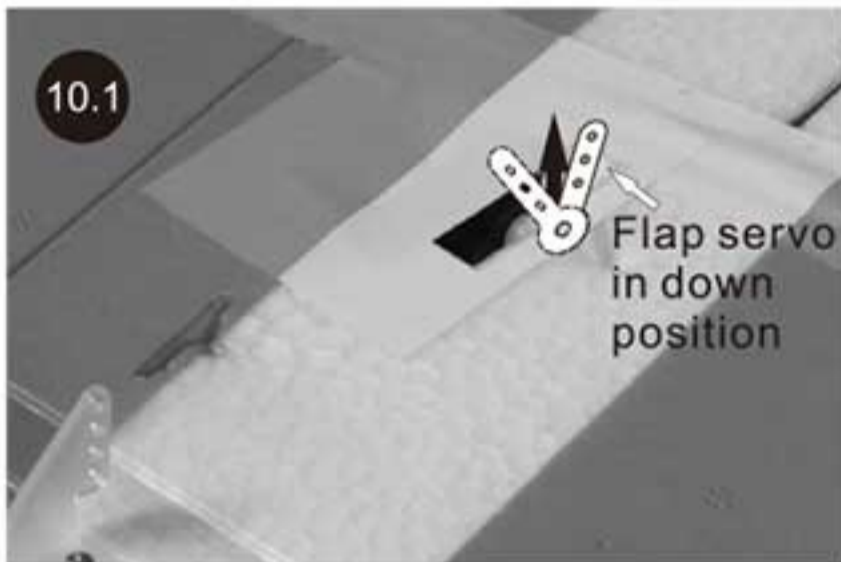

11. Seal the leads from the main landing gear fairing doors in the slot between the wing panels. Or it will impede the main wing from fully mounted into the wing saddle.



12. Tie the leads from the wing well using tape and make sure spare the two more extra leads from the Ch2 and the sequencer for rear landing gear and elevator control surface.



Mount the main wing

1. The left and right wing fillet.

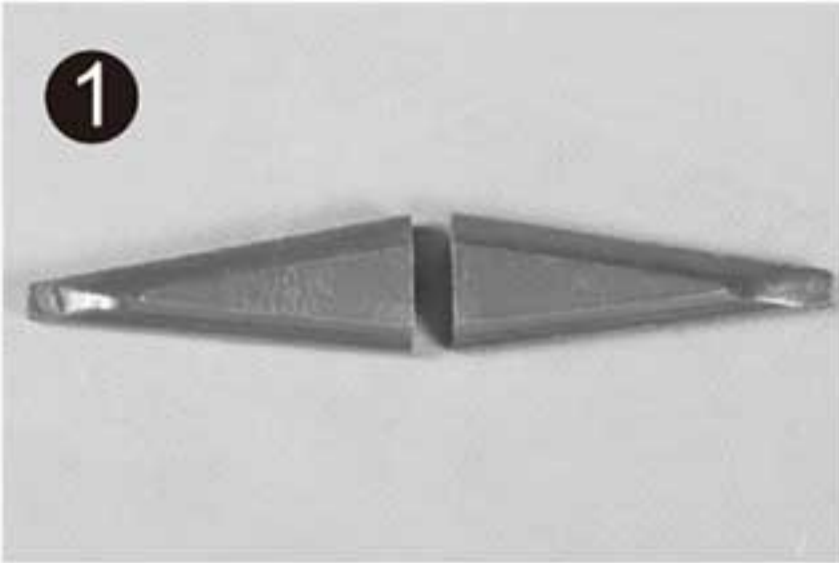

2. Fit the wing filler into place rightly.
The fillet mounted the wrong way round.
Note: If the filler mounted the wrong way into the notch it will not perfectly fitted into place.

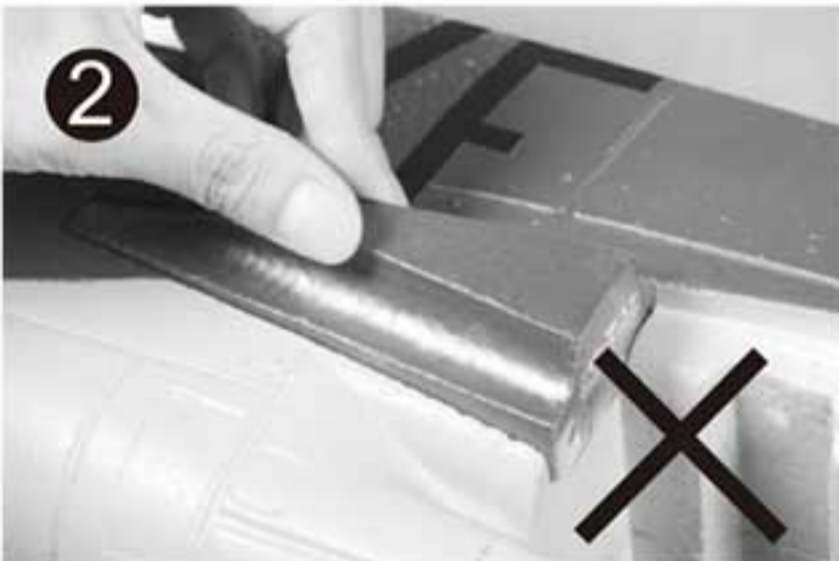

3. The filler mounted the right way.

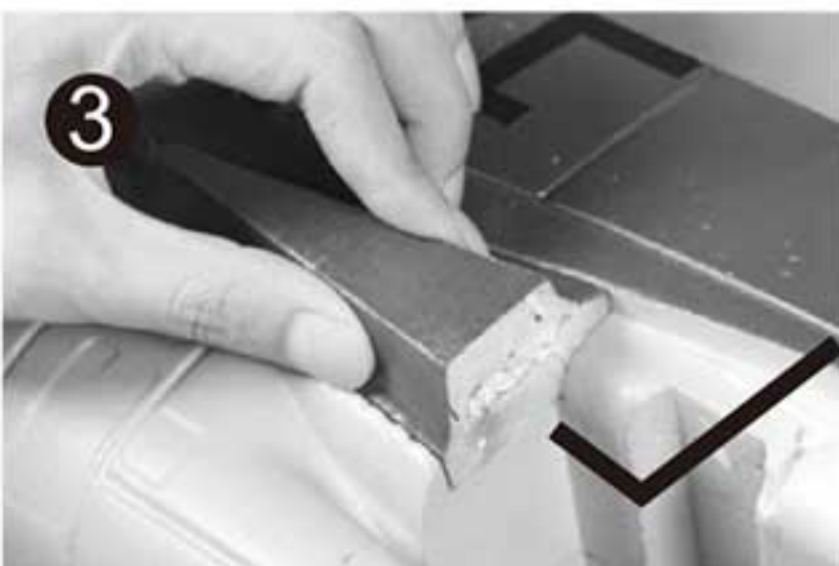

4. Take the filler out and glue it back where you fitted it.

Note: Apply glue to where the filler and the fuselage fitted together. Seat it into place as soon as the glue apply completed since the resistance will increase rapidly when the glue getting dry. Repeat the same step for the other filler install.



Mount the main wing

5. Mount the wing to the fuselage by fitting the rear side of the main wing to the groove under the air cooling intake vent.

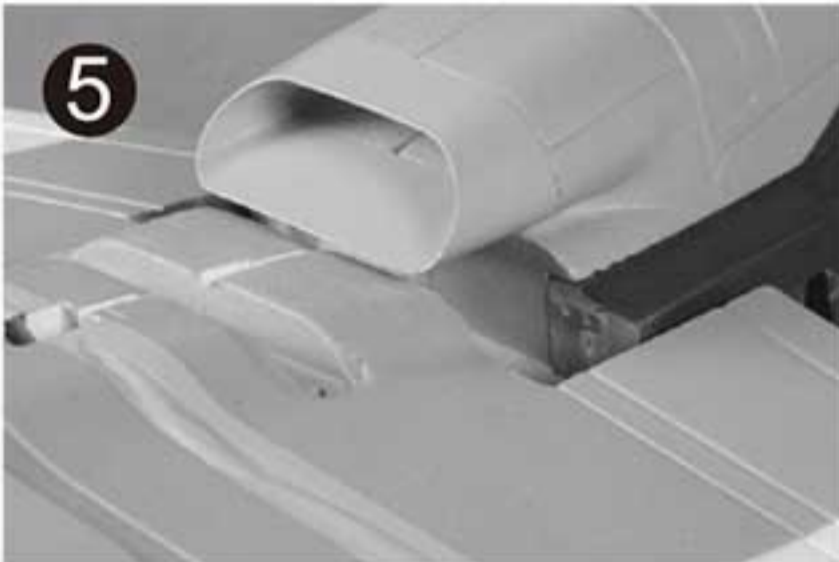

6. Guide the cables from the wing panels through the hole in the bottom of the fuselage wing bay. Put the wing into place and gently pull the cables from inside of the canopy simultaneously to avoid any tangling of the cables.

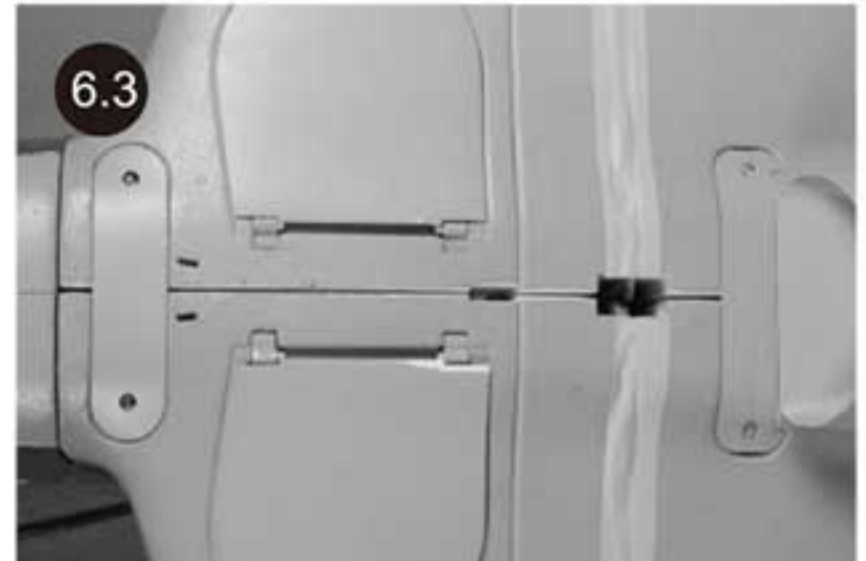

7. Secure the rear main wing bolt plate using the provided machine screws. (PM 3.0X60 2PCS)

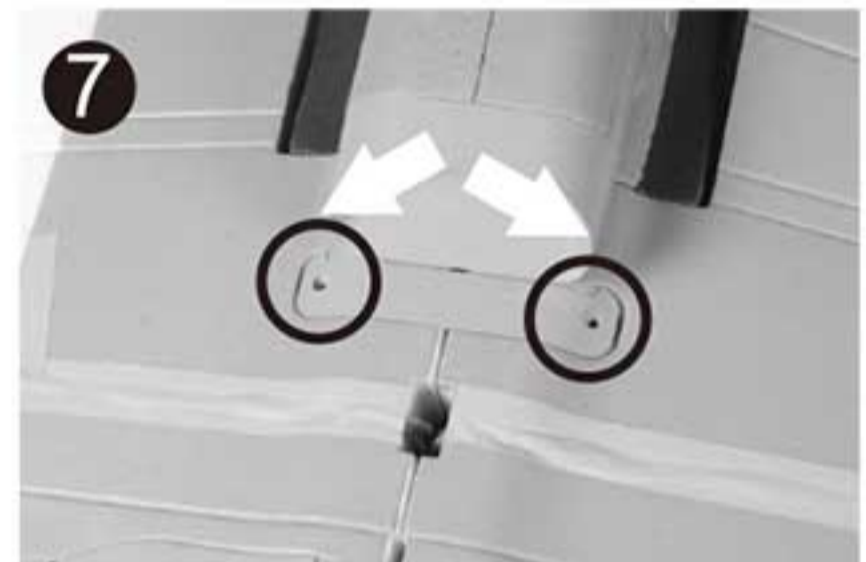

8. Secure the front main wing bolt plate using the provided machine screws. (PM 3.0X45 2PCS)

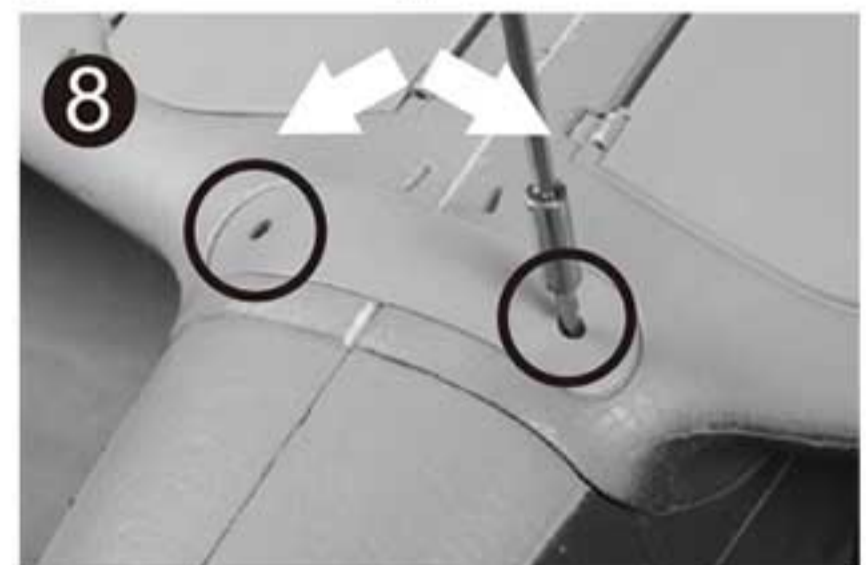

step5

Install the stabilizer

1. Fix the horizontal stabilizer into place with the nose insert into the fuselage slot. Make sure it fully seated into place.

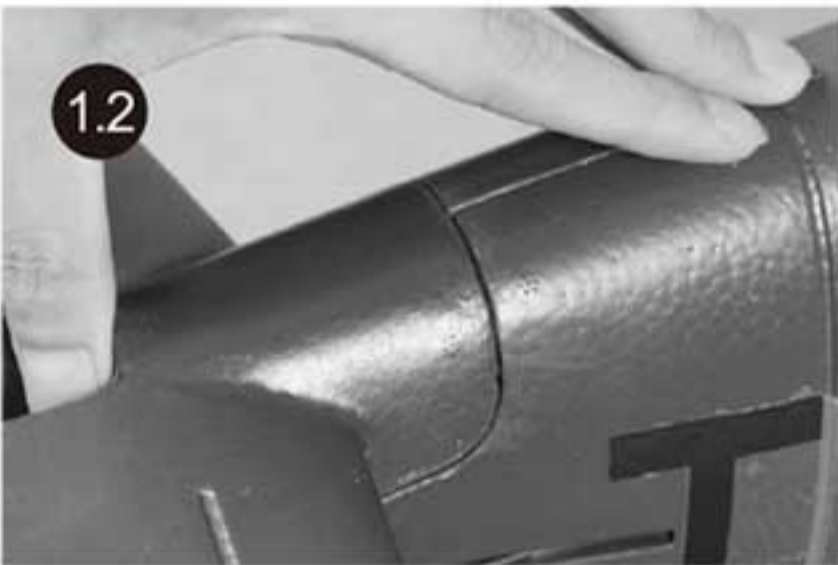
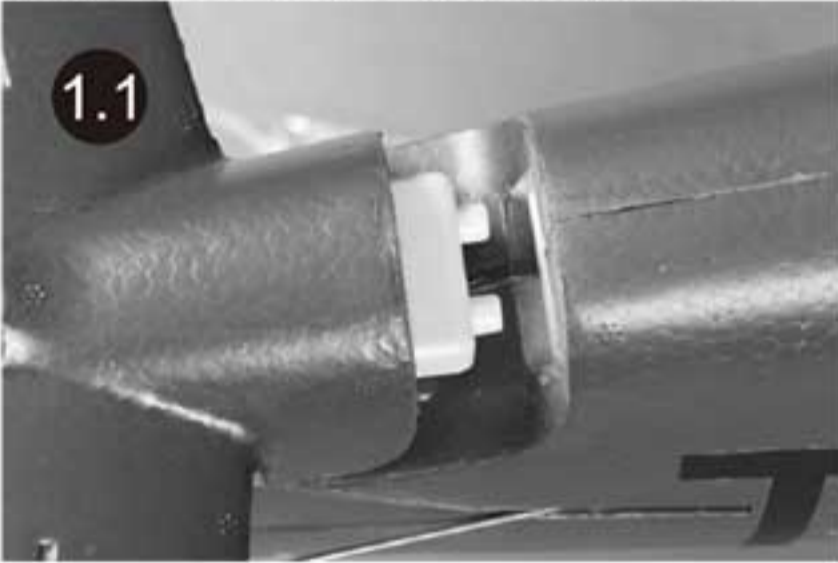

2. Secure the rear side of the stabilizer using the provided screw. (PA 2.6*40 1PC) Do not over tighten the screw, but make sure it's tight enough.

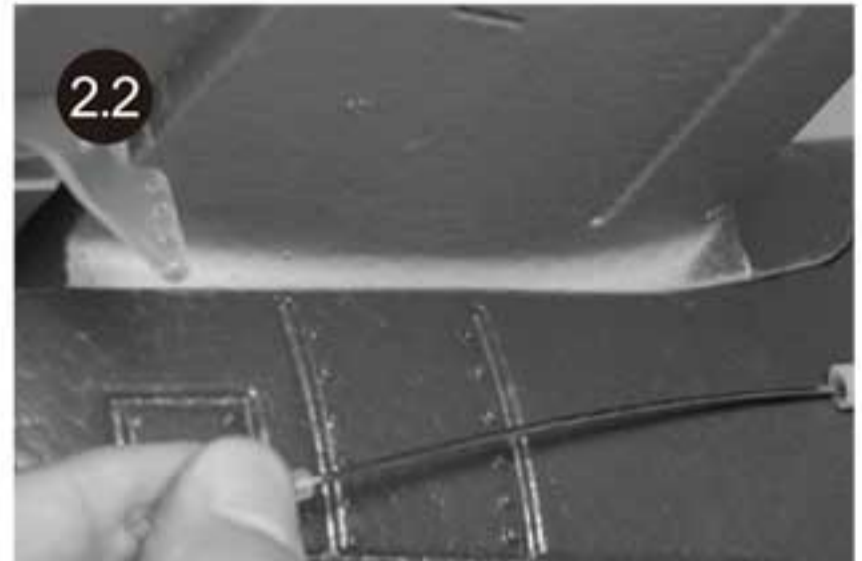
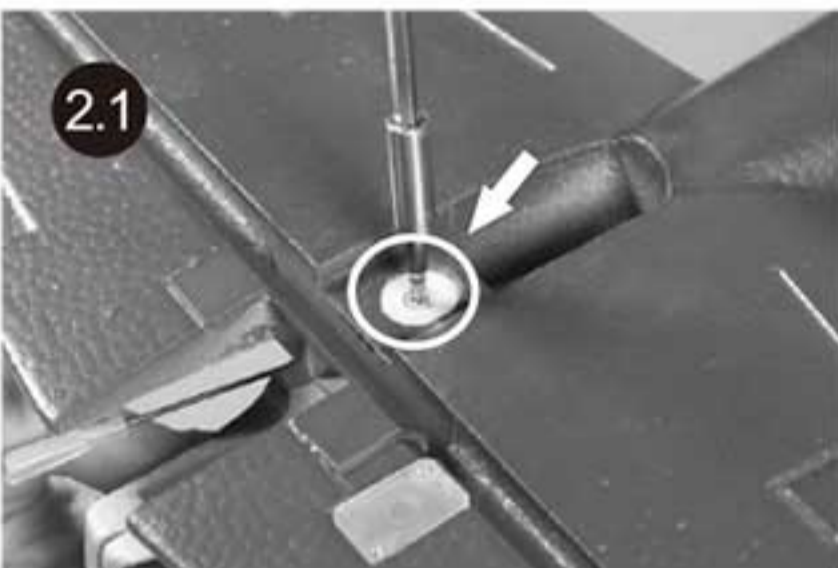

3. Mount the vertical fin into place and make sure the foamy hinge insert into the slot on the tail of the fuselage.



Install the stabilizer

4. After fitting the rudder into place properly, use the provided self tapping screw to attach the vertical fin to the fuselage from the underside of the tail part. Make sure the fin fully fitted into place.
(Screw: PA2.6X25mm 2PC)

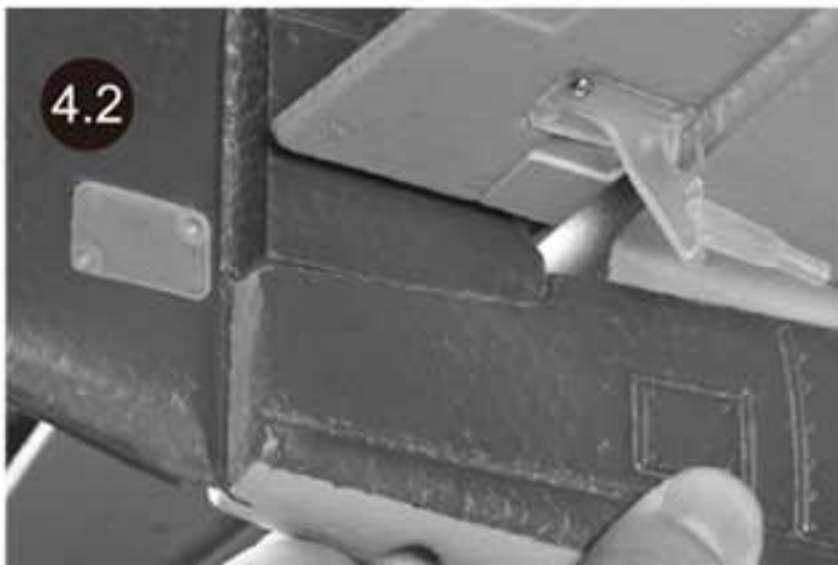
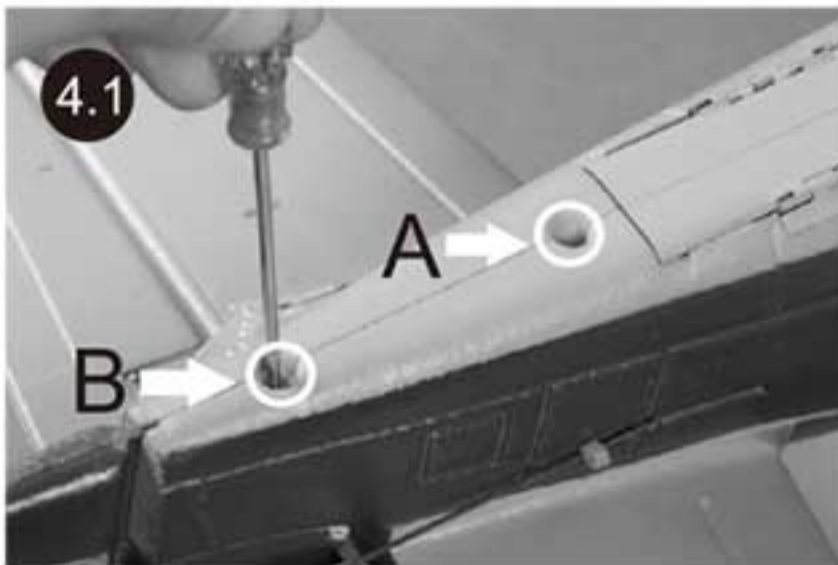

5. Apply glue to the foam hinge to protect it from tearing apart.

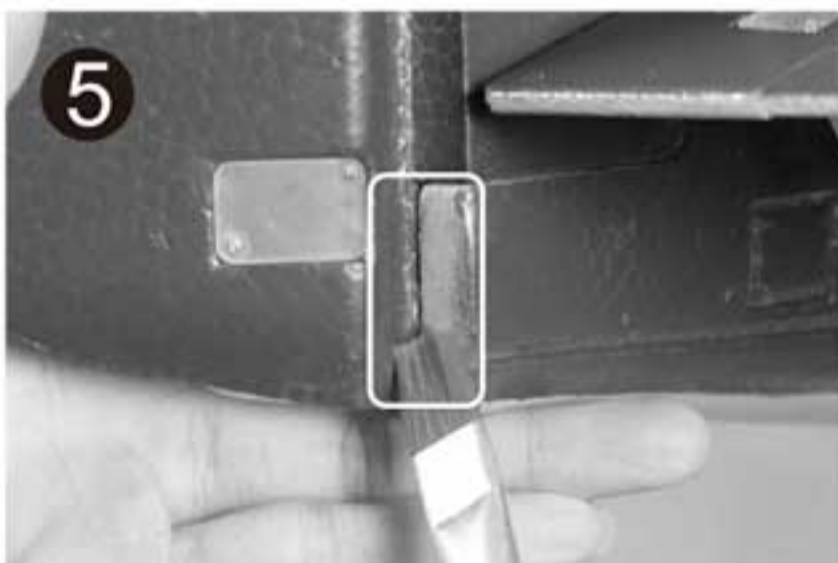

Important ESC information

1. The ESC included with the **P51 B** has a safe start. If the motor battery is connected to the ESC and the throttle stick is not in the low throttle or off position, the motor will not start until the throttle stick is moved to the low throttle or off position. Once the throttle stick is moved to the low throttle or off position, the motor will emit a series of beeps. Several beeps with the same tune means the ESC has detect the cells of the battery. The count of the beeps equal the cells of the battery. The motor is now armed and will start when the throttle is moved.
2. The motor and ESC come pre-connected and the motor rotation should be correct. If for any reason the motor is rotating in the wrong direction, simply reverse two of the three motor wires to change the direction of rotation.
3. The motor has an optional brake setting. The ESC comes with the brake switched off and we recommended that the **P51 B** be flown with the brake off . However, the brake could be accidentally switched on if the motor battery is connected to the ESC while the throttle stick is set at full throttle. To switch the brake off, move the throttle stick to full throttle and plug in the motor battery. The motor will beep one time. Move the throttle stick to low throttle or the off position. The motor is ready to run and the brake will be switched off.
4. Battery Selection and Installation. We recommend the 14.8V 2600mAh 25C(**270g/9.5oz**) Li-Po battery. If using another battery, the battery must be at least a 14.8V 2600mAh 25C battery. Your battery should be approximately the same capacity ,dimension and weight as the 14.8V 2600mAh 25C Li-Po battery to fit in the fuselage without changing the center of gravity significantly.











The control system testing

Before getting started, plug the receiver and rebind your receiver with your transmitter is necessary according the binding status of your receiver and the transmitter.

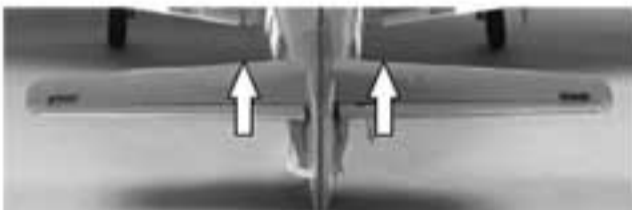
CAUTION: To prevent personal injury, DO NOT install the propeller assembly onto the motor shaft while testing the control surfaces . DO NOT arm the ESC and do not turn on the transmitter until the **Transmitter Manual** instructs you to do so.

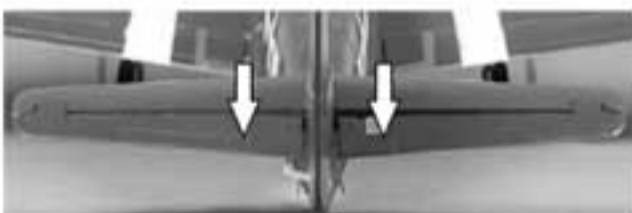
Tips: Make sure all control sticks on your radio are in the neutral position (rudder, elevator, ailerons) and the throttle in the OFF position. Make sure both ailerons move up and down (travel) the same amount. This model tracks well when the left and right ailerons travel the same amount in response to the control stick.

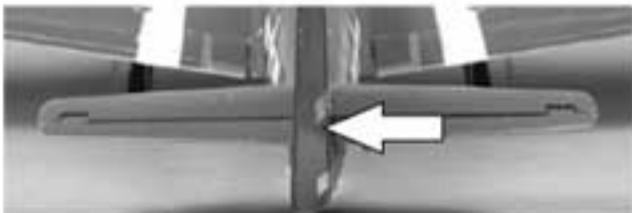
1. Move the controls on the transmitter to make sure aircraft control surface move correctly. See diagrams below. If controls respond in the opposite direction reverse the direction for operation of flight controls. Refer to your transmitter's instructions for changing direction of transmitter flight controls.

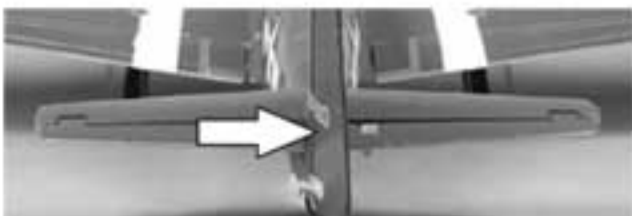
	Bank Left		Aileron
	Bank Right		
	Climb		Elevator
	Descend		
	Yaw Left		Rudder/ Steering
	Yaw Right		

The control system testing

2. Adjust the servo arms mechanically make sure all servo arms are fully vertical. If not, adjust the servo arm by using the trim function on your radio.
Note: For computerized transmitters, use the servo/channel sub-trim feature to make each servo arm fully vertical. Make sure the trims and the sub trims in neutral position before making some mechanically trim.
3. The standard hole settings for linkage connections are shown by the black arrows in the the diagram below. You can refer the recommended control throw setting to move the linkage to different hole positions to increase control surface travel and increase the aerobatics of the airplane. For the computerized transmitter, please refers to the **Low and High rate** setting for more accurate control throw setting.

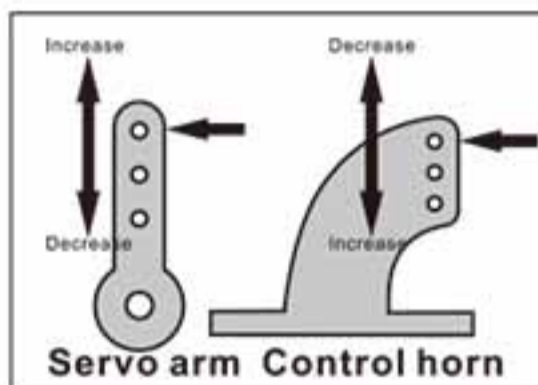

	High rate	Low rate
Elevator -	40mm/1.6in up and down	24mm/0.9in up and down
Rudder -	25mm/0.98in left and right	21mm/0.8in left and right
Ailerons -	28mm/1.1in up and down	17mm/0.7in up and down
Flaps -	Mid 22mm/0.9in Full 45mm/1.8in	

4. Align the aileron control surfaces well by turning the clevis clockwise and counterclockwise on the linkage rod. The aileron align with the wing tip trailing edge, the wing chord of the stabilizer and the elevator will arrange in a line.
Note: Secure the clevis using the securing tube after the alignment of the surface is completed.

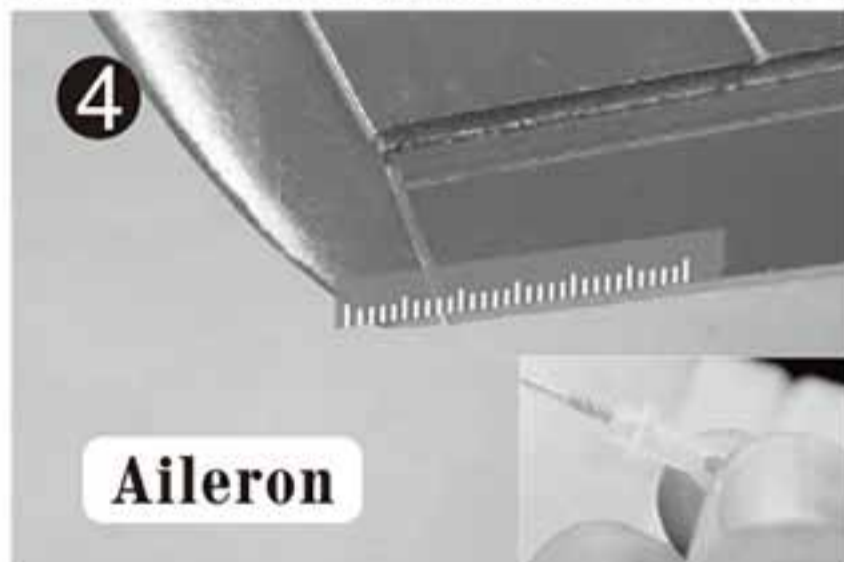

5. Align the elevator control surfaces well by adjusting the linkage secured in the control connector. The wing chord of the stabilizer and the elevator will arrange in a line.
Note: Use a drop of thread lock on the grub screws before securing the linkage rod.

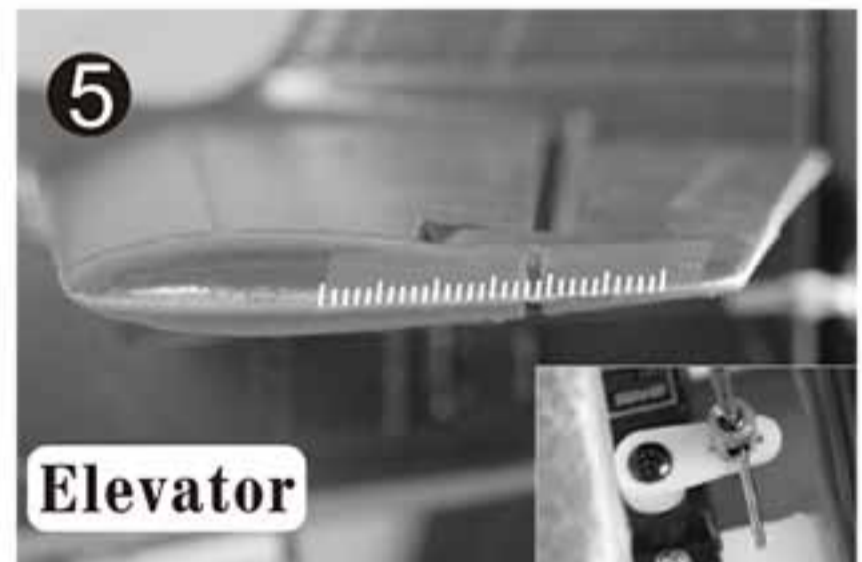

6. Align the tail wheel with the fuselage centerline before align the rudder with the vertical fin. Repeat the **Step 5** to align the rudder with the vertical fin.



The control system testing

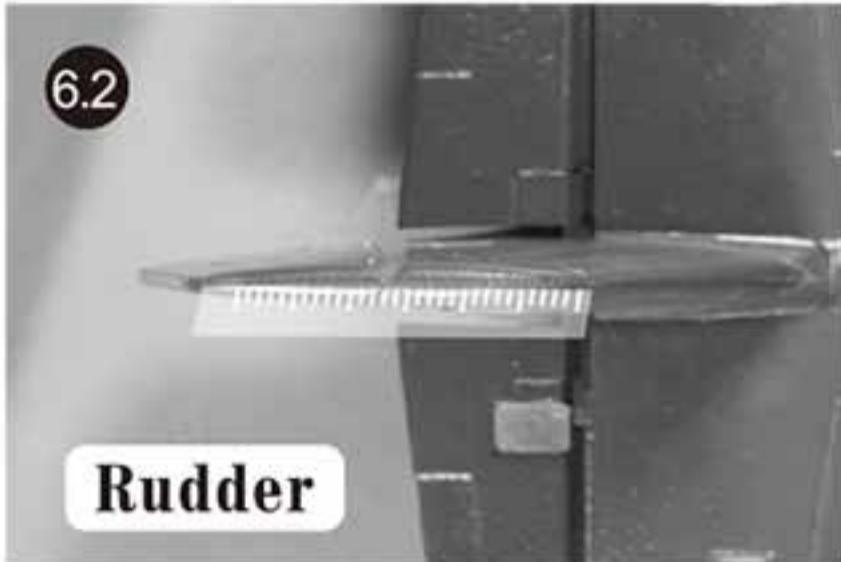

7. Test the motor make sure it is responsive to the throttle input and rotate the clock wise from the tail view, or you have to reset the throttle.



The control system testing

1. The propeller and the spinner kit.



2. Place two Nylon Insert Lock Nuts rightly into the hex notch on bottom of the spinner back plate.
Note: Always hold the nuts into place in the process of the blades mounting.



3. Take one of the propeller blades and properly fit it into the corresponding notch on top of the spinner backplate. Make sure that the paint side of the blade faces the right direction. Attach the blade to the spinner backplate with two machine screws. (Screws: PM3.0x18 8PCS)



4. Repeat the steps 2&3 for the rest three blades mounting.



Install the propeller assembly

CAUTION: Before testing the propeller, make sure the tail of the plane is firmly on the ground and ensure there are no people or objects in the range of the propeller. Make sure the throttle stick and the trim on the lowest position before plug in the battery.

1. Keyed the propeller assembly to the motor shaft, make sure to fit the assembly into the hex nut on the shaft, it will help to hold the assembly in fixed position when the engine contact.



2. Take the washer and thread it to the motor shaft, it will help to prevent the propeller holder from the nut scrape.



3. Secure the propeller by tighten the nut use the screw driver, do not over tighten, but make sure it's tight enough.



4. Rightly fit the spinner into place, make sure the holes in the spinner perfectly matched with the dowel on the backplate that hold the screws into place.



5. Fit the spinner into place.



6. Secure the spinner using the provided screws. (PA 2.6X10 2PCS)



Install the accessory parts of the plane

1. Attach the receiver to the hatch in front of the canopy bay as the picture shows.



2. Slide the battery plate out, make sure the receiver do not impede the moving path of the plate.

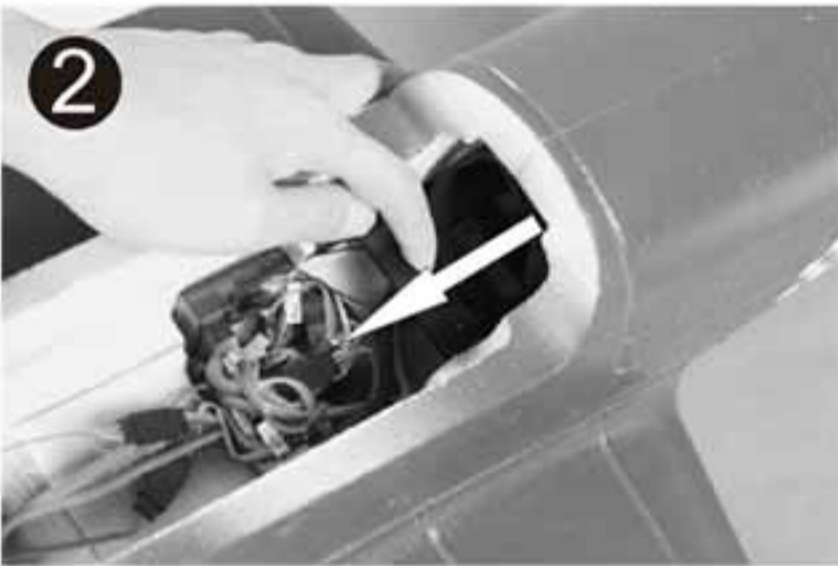

3. Verify the battery tray, the loop and hook tape will help you to locate the battery pack.



4. Secure the battery in place with the cable toward the rear end of the plane.

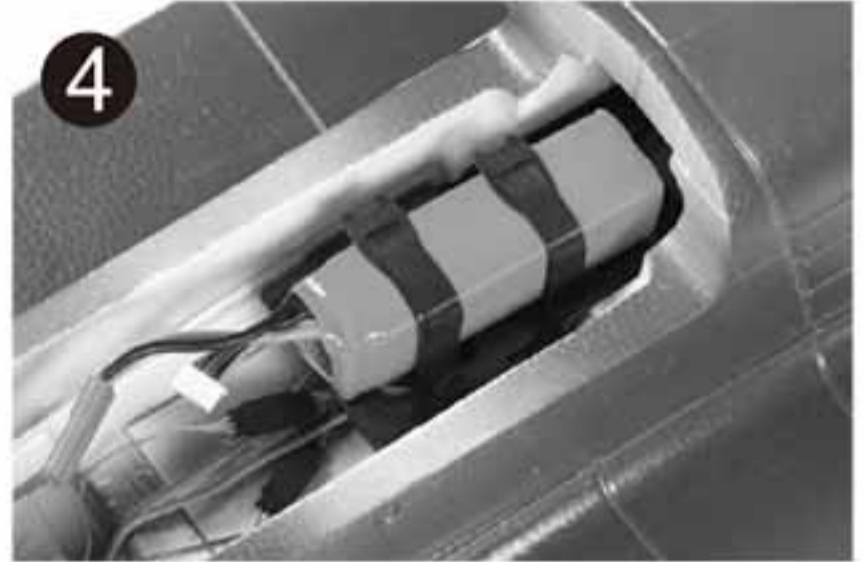

5. Snap the pack in along the mounting rail, you may need to adjust the battery position for the appropriate CG recommended on page 20.

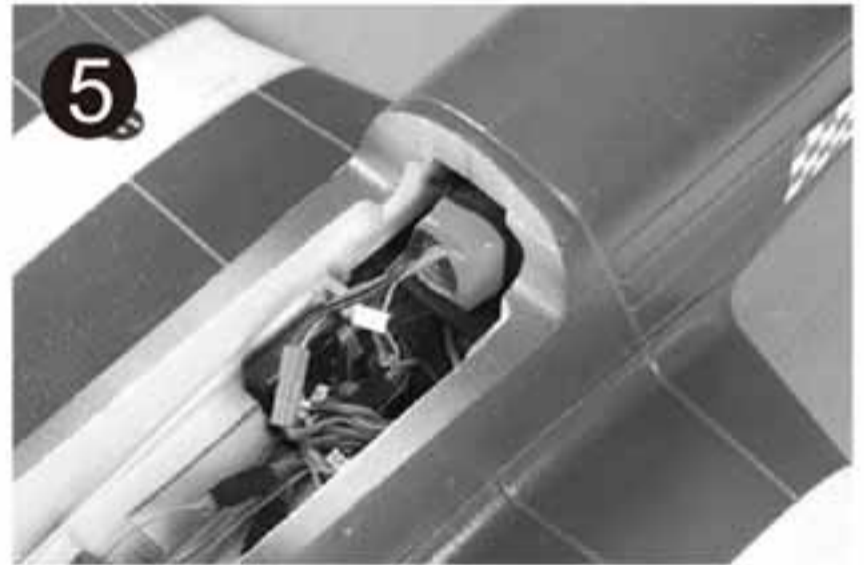

Install the accessory parts of the plane

6. Glue the air exhaust stack in to place as the picture shows.
Note: Fit the stacks into place the first without the glue application to make sure the stacks attached to the right side.



7. Apply glue to the triangular tap part of the antenna mast and fit it into the slot on top of the canopy.



8. Position one of the gun set in to place, it will match perfectly with gun set hatch with the gun barrel toward straight forward. If not, you will have to change other one. Take the set out and glue it back into place. Repeat the same steps for the other set installation.

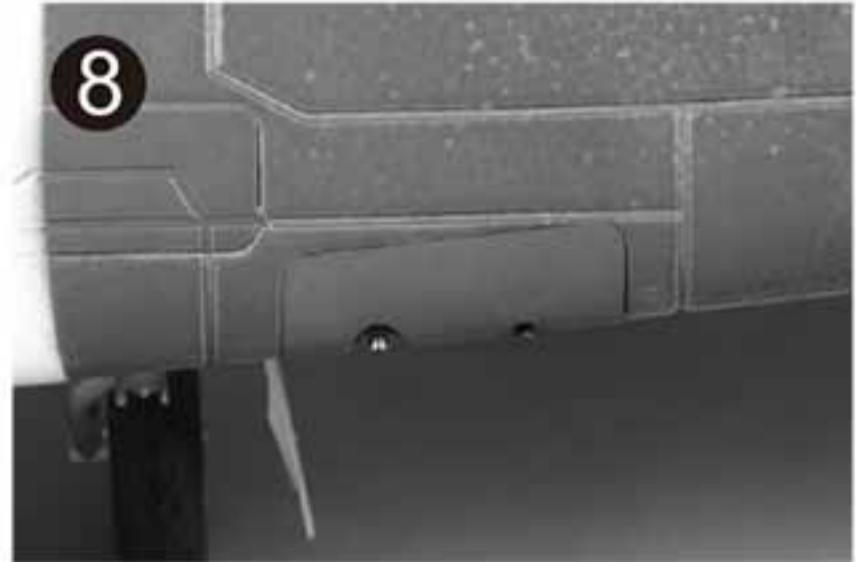

9. Slide the oil tanks into the tanks rack, two tanks are the same, you can take any one of them to hang on a rack.

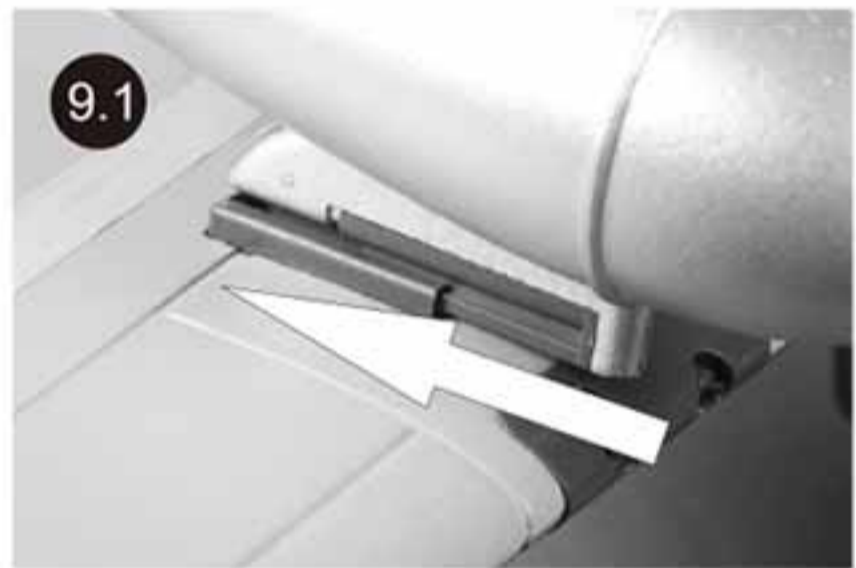

The wire connection

1. Multiple Connector Part 1



2. Multiple Connector Part 2



3. Plug the Part 1 to the part 2 properly as the picture show.



4. CH5.B for the rear landing gear retract.

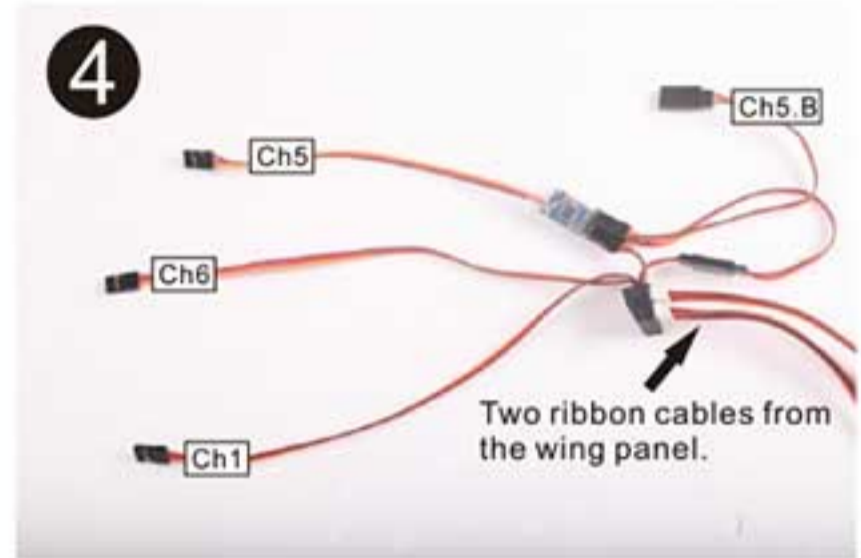

5. Diagram for the sequencer connection.







6. Diagram for the receiver connection. The recommended voltage input for the receiver is 4.8V-6V.

		Receiver
Aileron	Ch1	Channel-1
Elevator	Ch2	Channel-2
Throttle	Ch3	Channel-3
Rudder	Ch4	Channel-4
Landing Gear	Ch5	Channel-5
Flap	Ch6	Channel-6

Maintenance mark applying instruction

Note: Please apply the maintenance mark details as the guiding sketch shows.

W	REAR MOUNT LOADING DOOR 50 CAL ARMoured	Z	UPPER FEEDWAY DOOR 50 CAL ARMoured	
W	REAR MOUNT LOADING DOOR 50 CAL ARMoured	Z	UPPER FEEDWAY DOOR 50 CAL ARMoured	
D	AILERON TRIM ADJM ACCESS	J	EXTERNAL POWER RECEPTACLE 24 VOLTS	
D	AILERON TRIM ADJM ACCESS	B	ENGINE STARTER CRANK	
K	BATTERY LOCATION HERE	V	OIL DRAIN	 
I	EMERGENCY CANOPY RELEASE	V	OIL DRAIN	
X	CAP Y 75 U S GAL 82 S IMPGAL SUITABLE FOR AROMATIC FUEL	A	LIFT CAPTOR 1600LBS MOOR	
X	CAP Y 75 U S GAL 82 S IMPGAL SUITABLE FOR AROMATIC FUEL	M	REMOVE FUEL DRAIN WATER REG	

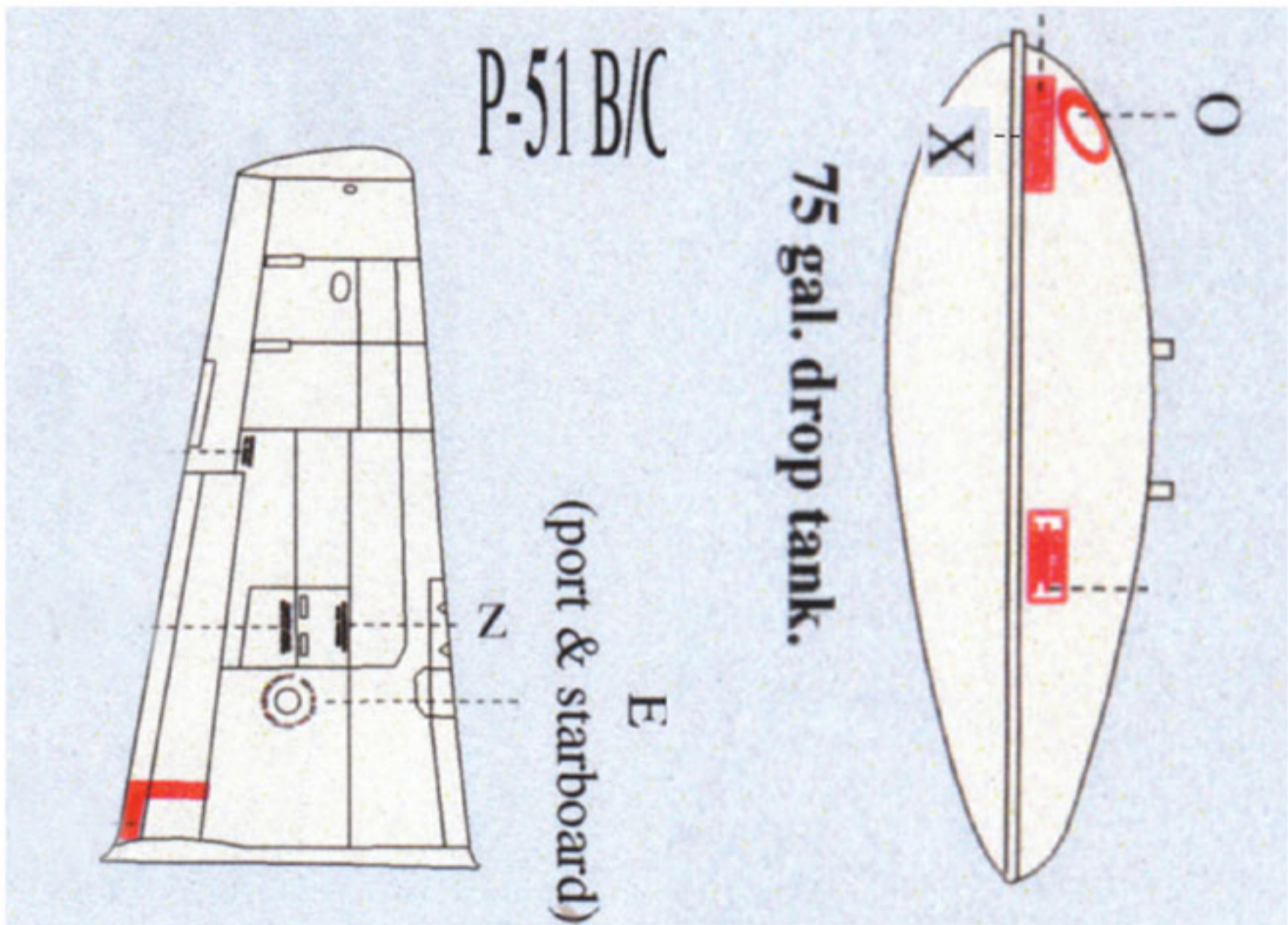

stencil instructions

(upper wing surface)

P-51 B/C

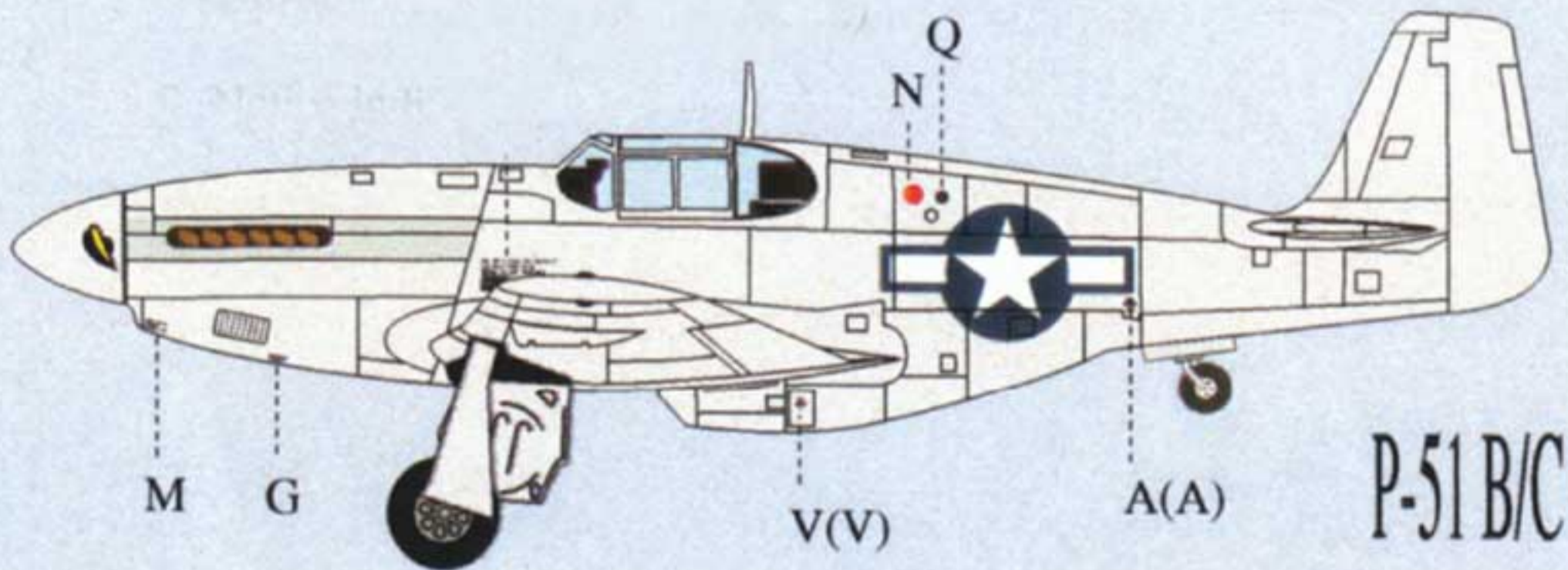
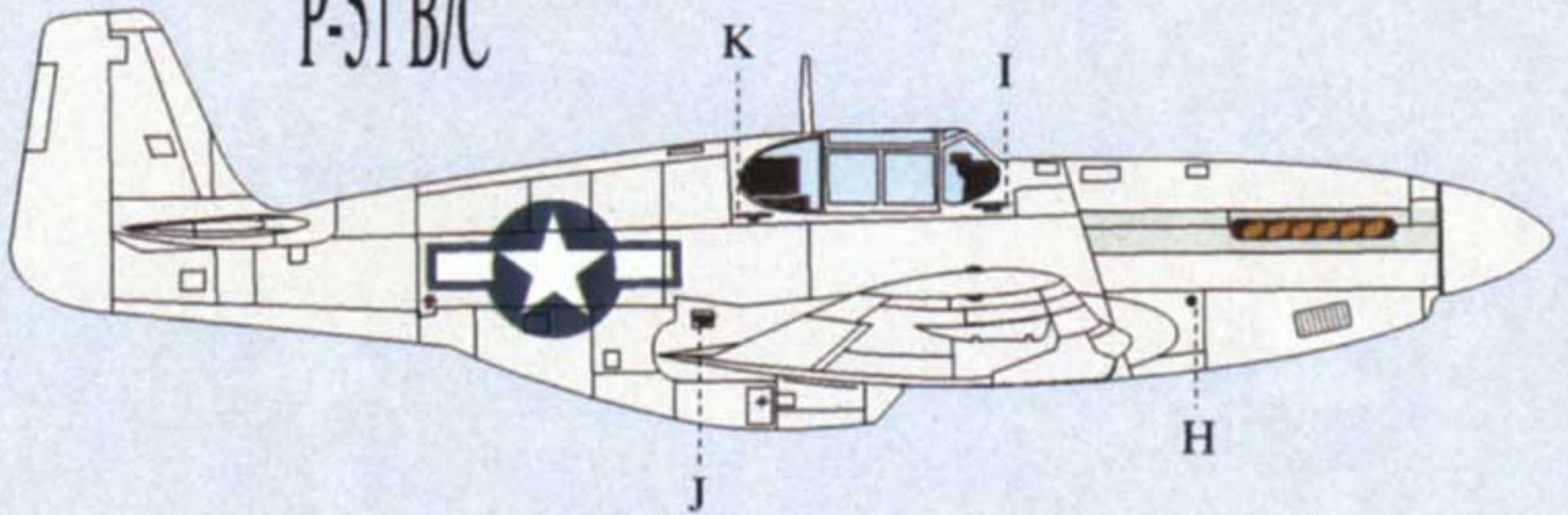

P-51 B/C

Check the C.G. (Center of Gravity)

Center of Gravity

When balancing your model, adjust the motor battery as necessary so the model is level or slightly nose down. This is the correct balance point for your model. After the first flights, the **CG** position can be adjusted for your personal preference.

1. The recommended Center of Gravity (**CG**) location for your model is (**110mm/4.3in**) forward from the leading edge of the main wing (as shown) with the battery pack installed. Mark the location of the **CG** on top of the wing.

2. When balancing your model, support the plane at the marks made on the bottom of the main wing with your fingers or a commercially available balancing stand. This is the correct balance point for your model. Make sure the model is assembled and ready for flight before balancing.

Caution: Do not connect the battery to the ESC while balancing the plane. Always balance the plane with the retract down.

Specification

Wing span: 1450mm/57.0in

Length: 1240mm/49.0in

Motor : 4250-KV540

ESC : 70A with 5A BEC

Battery : 14.8V 2600mAh 25C

Servo : 17g*3, 9g*6

Approx flying weight: 2250g

Propeller: 14*8 four blades scale propeller

Wing area: 38.7dm²

Wing loading: 58.1 g/dm²

The recommended TX &RX system: 6CH at least

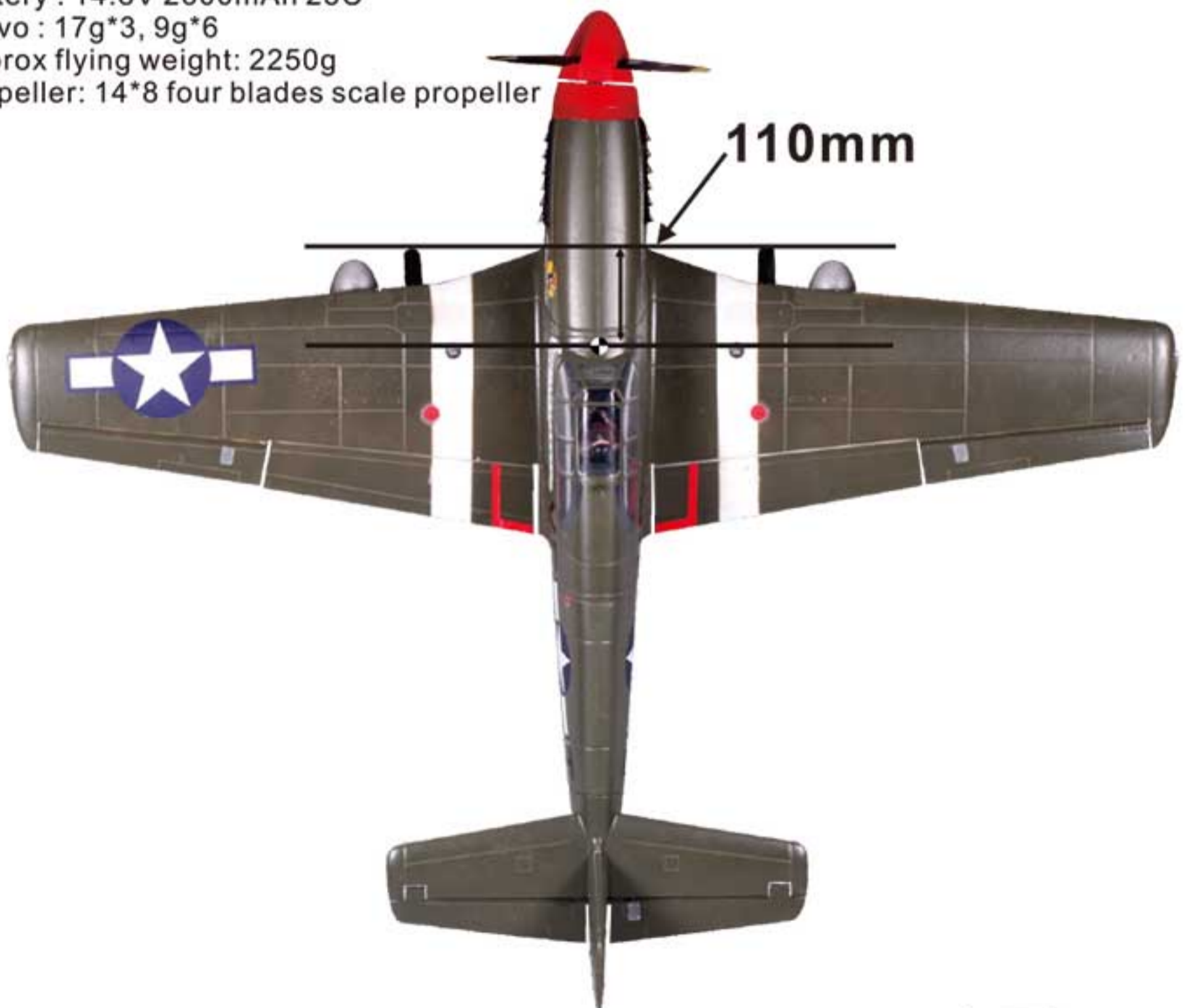

Spare Parts for 1450 MM P-51 B Mustang

ST 101 Fuselage
 ST 102 Main wing set
 ST 103 Horizontal Stabilizer
 ST 104 Vertical stabilizer
 ST 105 Canopy (The canopy and the cockpit with pilot)
 ST 106 Oil tank (Auxiliary fuel tanks)
 ST 107 Air scoop
 ST 108 Rear landing gear door
 ST 109 Machine gun set
 ST 110 Battery Tray
 ST 111 Wing bolt plate (The front and rear wing bolt plate)
 ST 112 Motor Board
 ST 113 Cowl
 ST 114 Propeller(4 pcs of propeller blades)
 ST 115 Spinner
 ST 117 Main landing gear strut(A set of main landing gear struts)
 ST 119 Rear landing gear system(Rear landing gear with the strut installed)
 ST 126 Aluminum motor base
 ST 127 Motor shaft(The shaft with the washer and nuts)
 ST 128 Linkage rod (The rod with the secure ring)
 ST 129 Screw set
 ST 130 Decal sheet
 ST 131 Detailed decal sheet
 ST 132 Tire set
 ST 133 Inner fairing door
 ST 134 Outer fairing door
 ST 137 Multiple Connector Part 1(From the wing panels)
 ST 138 Multiple Connector Part 2 (For plugging to receiver)
 ST 139 Pipe
 ST 140 Exhaust pipe
 ST 141 Main landing gear system(A set of landing gear struts with the 2pcs FMS retracts)
 ST 142 LED
 ST 143 Lamp Cover
 ST 144 Multiple Connector(For the wing panels & plugging to receiver)
 Retract 003 (For maing landing gear)
 Sequencer-3 sec P51 3 sec for PZ Retract
 Sequencer-6 sec P51 6 sec for FMS Retract
 FMSSER9MGDR (Reverse: Drive the inner fairing door)
 FMSSER9MGD-54DEG (For the rear landing gear steering)
 FMS-Motor-4250 KV540 Motor (4250-kv540)
 FMS-ESC-70A 5A SBEC (200mm length cable)
 FMSSER9MGD(9g digital metal gear servo)
 FMSSER9SLP (For flaps (with 300mm length cable))
 FMSSER17MGD (17g digital metal gear servo)

Note: 1. All spare parts without decals.
 2. The Item# without color marking could be applied universally for both color scheme.

Spare Parts List for Shangri-la Scheme



ST-101

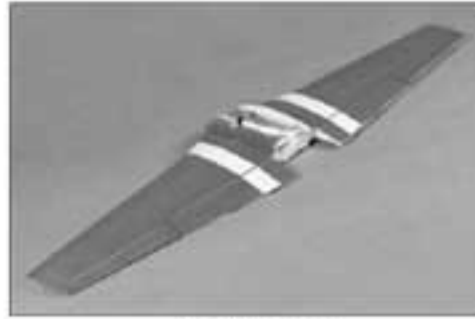

ST-102



ST-103



ST-104



ST-105



ST-106



ST-107



ST-108



ST-109



ST-110



ST-111



ST-112



ST-113



ST-114



ST-115



ST-117



ST-119



ST-126



ST-127



ST-128



ST-129



ST-130

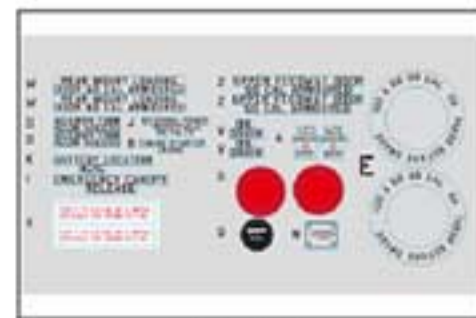

ST-131



ST-132

Spare Parts List for Shangri-la Scheme



ST-133

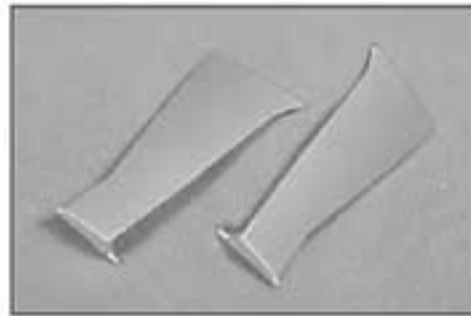

ST-134



ST-137



ST-138



ST-139



ST-140



ST-141



ST-142

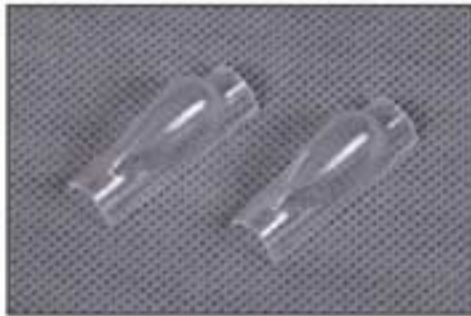

ST-143

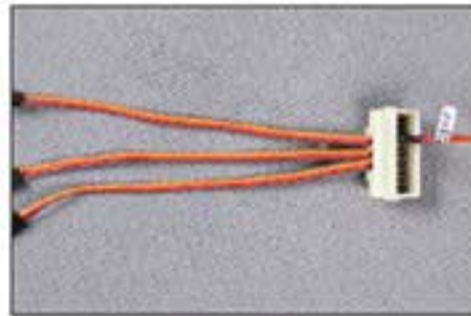

ST-144



Retract 003

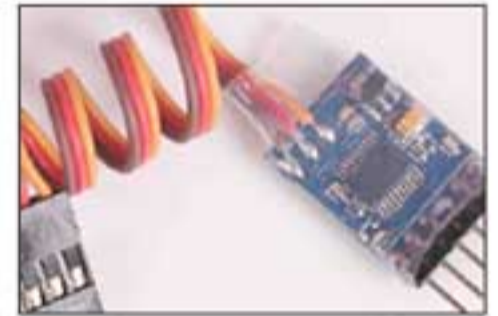

Sequencer-3



Sequencer-6



FMSSER9MGDR



FMSSER9GMGD-54DEG



Motor-4250 Kv540



ESC-70A 5A SBEC



FMSSER9MGD



FMSSER9SLP



FMSSER17MGD

ESC instruction

Wires Connection:

The electronic speed controller can be connected to the motor by soldering directly or with high quality connectors. Always use new connectors, which should be soldered carefully to the cables and insulated with heat shrink tube. The maximum length of the battery pack wires shall be within 6 inches.

- Solder controller to the motor wires.
- Solder appropriate connectors to the battery wires.
- Insulate all solder connectors with heat shrink tubes.
- Plug the "JR" connector into the receiver throttle channel.
- Speed Controller Red and Black wires connects to battery pack Red and Black wires respectively.

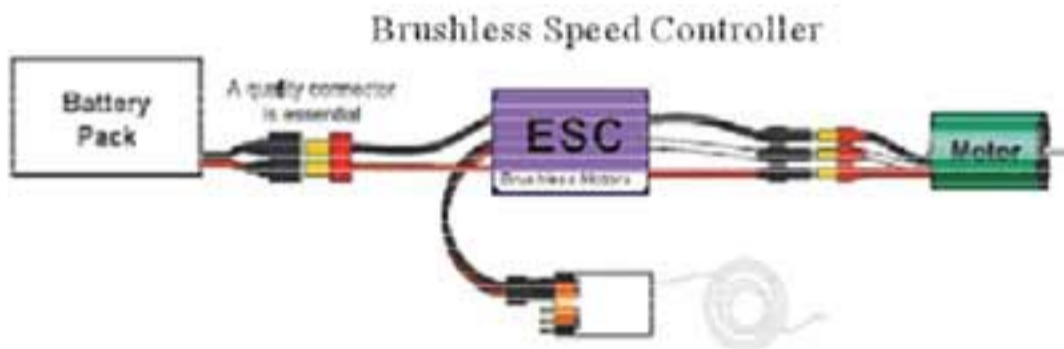

Specification:

Model #	Cont. Current(A)	Burst Current (A) 10s.	Battery cell NiXX/Lipo	Weight (g)	BEC Output	Size (mm) W*L*H	User Program
6A	6A	8A	5-10 NC \ 2-3 Lipo	5	5volts / 2amps	13 x 21 x 4	yes
12A	12A	16A	5-12 NC \ 2-4 Lipo	8	5volts / 1amps	21 x 22 x 4	yes
20A	20A	30A	5-12 NC \ 2-4 Lipo	18	5volts / 3amps	13 x 21 x 4	yes
30A	30A	40A	5-12 NC \ 2-4 Lipo	30	5volts / 3amps	23 x 43 x 6	yes
35A	35A	45A	5-12NC \ 2-4 Lipo	47	5volts / 4amps	28 x 38 x 8	yes
40A	40A	50A	5-12 NC \ 2-4 Lipo	44	5volts / 3amps	28 x 38 x 8	yes
45A	45A	55A	5-12 NC \ 2-4 Lipo	42	5volts / 3amps	31 x 58 x11	yes
50A	50A	70A	5-18NC \ 2-6 Lipo	45	5.5volts / 5amps	31 x 58 x 11	yes
60A	60A	70A	5-12NC \ 2-4Lipo	50	5.5volts / 3amps	36 x 50 x 8	yes
65A	65A	85A	5-18NC \ 2-6Lipo	58	5.5volts / 5amps	30 x 56 x 11	yes
70A	70A	75A	5-12NC \ 2-6 Lipo	56	5.5volts / 5amps	34 x 52 x 14	yes
85A	85A	100A	5-18NC \ 2-6Lipo	63	5.5volts / 5amps	34 x 52 x 14	yes

Features:

- ◆ Extremely low internal resistance
- ◆ Super smooth and accurate throttle linearity
- ◆ Safety thermal over-load protection
- ◆ Auto throttle shut down in signal loss situation
- ◆ Supports high RPM motors
- ◆ Power arming protection (prevents the motor from accidentally running when switched ON)
- ◆ New advanced programming software

Our ESC allows you to program parameters to fit your specific needs:

Our ESC allows you to program parameters to fit your specific needs:

1. User programmable brake setting (we recommend using brake for only folding props applications)
2. User programmable battery type (LiPo or NiCd/NiMh)
3. User programmable low voltage cutoff setting
4. User programmable factory default setting restore
5. User programmable timing settings (to enhance ESC efficiency and smoothness)
6. User programmable soft acceleration start ups (for delicate gearbox and helicopter applications)
7. User programmable governor mode (for helicopter applications)
8. User programmable motor rotation (clockwise\counterclockwise)
9. User programmable switching frequency
10. User programmable low voltage cutoff type (power reduction or immediate shutdown)

Settings:

1. Brake: ON/OFF

* ON-Sets the propeller to the brake position when the throttle stick is at the minimum position (Recommended for folding props).

* OFF-Sets the propeller to freewheel when the throttle stick is at the minimum position.

2. Battery type: LiPo or NiCad/NiMh

* NiCad/NiMh – Sets Low Voltage protection threshold for NiCad/NiMh cells.

* LiPo – Sets Low voltage protection threshold for LiPo cells and automatically detects the number of cells within the pack.

Note: Selecting the NiCad/NiMh option for the battery type, triggers the ESC to automatically set the cutoff threshold to the factory default of 65%. The cutoff threshold can then be subsequently altered through the Low Voltage protection function, if required. The ESC will read the initial voltage of the NiCad/NiMh pack once it is plugged in and the voltage read will then be used as a reference for the cutoff voltage threshold.

3. Low Voltage Protection Threshold (Cutoff Threshold):

Low / Medium / High

1) For Li-xx packs- number of cells are automatically calculated and requires no user input apart from defining the battery type. This ESC provides 3 setting options for the low voltage protection threshold; Low (2.8V)/ Medium (3.0V)/ High (3.2V). For example: the voltage cutoff option for an 11.1V/ 3 cell Li-Po pack would be 8.4V (Low)/ 9.0V (Med)/ 9.6V (High)

2) For Ni-xx packs-low / medium / high cutoff voltages are 50%/65%/65% of the initial voltage of the battery pack. For example: A fully charged 6 cell NiMh pack's voltage is $1.44V \times 6 = 8.64V$, when "LOW" cutoff voltage is set, the cutoff voltage is: $8.64V \times 50\% = 4.3V$ and when "Medium" or "High" is set, the cutoff voltage is now $8.64V \times 65\% = 5.61V$.

4. Restore factory setup defaults:

Restore - Sets the ESC back to factory default settings;

Brake :	Off
Battery type Detect :	LiPo with Automatic Cell
Low voltage cutoff threshold :	Medium (3.0V/65%)
Timing setup :	Automatic
Soft Acceleration Start Up :	Medium
Governor mode :	OFF
Frequency :	16kHz
Low voltage cutoff type :	Reduce power

5. Timing setup: Automatic / Low / High.

- * Automatic – ESC automatically determines the optimum motor timing
- * Low (7-22 deg) – Setting for most 2 pole motors.
- * High (22-30 deg)-setting for motors with 6 or more poles.

In most cases, automatic timing works well for all types of motors. However for high efficiency we recommend the Low timing setting for 2 pole motors (general in-runners) and high timing for 6 poles and above (general outrunners). For higher speed, High timing can be set. Some motors require different timing setups therefore we suggest you follow the manufacturer recommended setup or use the automatic timing setting if you are unsure.

Note: Run your motor on the ground first after making any changes to your motor timing!

6. Soft Acceleration Start ups: Very Soft / Soft Acceleration/ Start Acceleration

- * Very Soft – Provides initial slow 1.5 sec ramp-up from start to full rpm intended to protect delicate gears from stripping under instant load. This setting is recommended for either fixed wing models equipped with gearboxes and / or helicopters.
- * Soft Acceleration- Provides initial slow 1 sec ramp-up from start to full rpm. This setting is recommended for either fixed wing models equipped with gearboxes and or helicopters.
- * Start Acceleration – Provides quick acceleration start ups with a linear throttle response. This is recommended for fixed wing models fitted with direct drive setups.

7. Active RPM Control (Heli Governor Mode)

- * RPM control off

* **First range:** There will be a 5-second delay from start to full rpm, but if the throttle is cutoff after starting, then the next start will be as normal start.

* **Second range:** There will be a 15-second delay from start to full rpm, but if the throttle is cutoff after starting, then the next start will be as normal start.

Note: Once the Governor Mode is enabled, the ESC's Brake and Low Voltage Cutoff Type settings will automatically be reset to No Brake and Reduce Power respectively regardless of what settings they were previously set.

8. Motor Rotation: Reverse

In most cases motor rotation is usually reversed by swapping two motor wires. However, in cases where the motor cables have been directly soldered to the ESC cables, motor rotation can be reversed by changing the value of setting on the ESC.

9. Switching Frequency: 8 kHz/16kHz

- * 8 kHz – Sets ESC switching frequency for 2 pole motors, e.g. in-runners.
- * 16 kHz – Sets ESC switching frequency for motors with more than 2 poles, e.g. out-runners.

Although 16 kHz is more efficient without Thrust motors, the setup default is 8 kHz due to the higher RF noises caused at 16 kHz.

10. Low Voltage Cutoff Type: Reduce Power / Hard cutoff

- * Reduce Power – ESC reduces motor power when the pre-set (recommended).
- * Hard Cutoff – ESC instantly cuts motor power when the pre-set Low Voltage Protection Threshold value is reached.

Programming Mode Audible Tones

Programming Mode Audible Tones	ESC Functions
0 Throttle Calibration (within the first 4 Sec) ● ● ● ●	

step 14

1	Brake * * * *	Brake On /Off
2	Battery type ~ ~ ~ ~ ~ ~ ~ ~	NiCad LiPo
3	Low Voltage Cutoff Threshold *	Low 2.8V/50% Medium 3.0V/60% High 3.2V/65%
4	Restore Factory Setup Defaults - - - -	Restore
5	Timing Setup - - - - - - - - - - - -	Automatic (7-30°) Low (7-22°) High (22-30°)
6	Soft Acceleration Start Ups ∨	Very Soft Soft Acceleration Start Acceleration
7	Governor Mode * * * * ** ** ** ** *** ** ** **	Rpm off Heli first range Heli second range
8	Motor Rotation W W W W	Positive/Reverse
9	Switching Frequency // // // // // // // //	8kHz 16kHz
10	Low Voltage Cutoff Type ☒ ☒ ☒ ☒ ☒ ☒ ☒ ☒	Reduce Power Hard Cut Off

Using Your New ESC

Improper polarity or short circuit will damage the ESC therefore it is your responsibility to double check all plugs for proper polarity and firm fit BEFORE connecting the battery pack.

Alert Tones

The ESC is equipped with audible alert tones to indicate abnormal conditions at power up.

If the ESC can't enter into working mode after powering up, indicates that you have not setup throttle calibration.

1. Continuous beeping tone (****) – Indicates that the throttle stick is not in the minimum position.
2. Single beeping tone followed by a one second pause (* * * *) – Indicates that the battery pack voltage is not within the acceptable range. (The ESC automatically checks and verifies the battery voltage once the battery is connected).
3. A single beeping tone followed by a short pause (* * * *) – Indicates that the ESC is unable to detect the normal throttle signal from the receiver.

Built-in Intelligent ESC Safety Functions

1. Over-heat protection: When the temperature of ESC exceeds 110 deg C, the ESC will reduce the output power to allow it to cool.
2. Lost Throttle signal protection: The ESC will automatically reduce output power to the motor when it detects a lost

of throttle signal for 2 second, a subsequent loss of throttle signal beyond 2 seconds, will cause the ESC automatically to cut power to the motor.

Powering up the ESC for the first time and setting the Automatic Throttle Calibration

The ZTW ESC features Automatic Throttle Calibration to attain the smoothest throttle response and resolution throughout the entire throttle range of your transmitter. This step is done once to allow the ESC to “learn and memorize” your Transmitter’s throttle output signals and only repeated if you change your transmitter.

1. Switch your Transmitter ON and set the throttle stick to its maximum position.
2. Connect the battery pack to the ESC. Wait for about 2 seconds, the motor will beep for twice, then put the throttle in the minimum position, the motor will also beep, which indicates that your ESC has got the signal range of the throttle from your transmitter.

The throttle is now calibrated and your ESC is ready for operation.

Normal ESC start up procedure:

1. Switch your Transmitter ON and set the throttle to its minimum position.
2. Connect the battery pack to the ESC.
3. When the ESC is first powered up, it emits two sets of audible tones in succession indicating the status of its programming state.
 - * The first set of tones denotes the number of cells in the LiPo pack connected to the ESC. (Three beeps (***) indicates a 3 cell LiPo pack while 4 beeps (****) indicates a 4 cell LiPo pack).
 - * The second set denoting Brake status. One beep (*) for Brake “ON” and two beeps (**) for Brake “OFF” .
 - * The ESC is now ready for use.

Entering the Programming Mode:

1. Switch your Transmitter ON and set the throttle to its maximum position.
2. Connect the battery pack to the ESC.
3. Wait until you hear two short beeps (__ **) confirming that the ESC has now entered the programming mode.
4. If within 5 seconds, the throttle stick is lowered to its minimum position, an audible tone is emitted confirming that the **throttle calibration** setting has changed. If the throttle stick is left in the maximum position beyond 5 seconds, the ESC will begin the sequence from one function and its associated setting options to another. (Please refer to the table below to cross reference the functions with the audible tones).
5. When the desired tone for the function and setting option is reached, move the throttle stick down to its minimum position. ESC will emit two beeps (**) confirming the new setting has been stored.
6. The ESC only allows the setting of one function at a time. Therefore should you require making changes to other function disconnect the battery pack and wait 5 seconds to reconnect the battery and repeat the above steps.

General Safety Precautions

Do not install the propeller (fixed wing) or drive pinion (helicopter) on the motor when you test the ESC and motor for the first time to verify the correct settings on your radio. Only install your propeller or pinion after you have confirmed that the settings on your radio is correct.

- Never use ruptured or punctured battery cells.
- Never use battery packs that are known to overheat.
- Never short circuit battery or motor terminals.
- Always use proper insulation material for cable insulation.
- Always use proper cable connectors.
- Do not exceed the number of cells or servos specified by the ESC.

Wrong battery polarity will damage the ESC and void the warranty.

- Install the ESC in a suitable location with adequate ventilation for cooling. This ESC has a built-in over heat cutoff protection feature that will immediately cut power to the motor once the ESC temperature exceeds the 230 Deg F/ 110 Deg C high temperature limit.
- Use only batteries that are supported by the ESC and ensure the correct polarity before connecting.
- Switch your Transmitter ON and ensure the throttle stick is in the minimum position before connecting the battery

pack.

- Never switch your transmitter **OFF** while the battery is connected to your ESC.
- Only connect your battery pack just before flying and do not leave your battery pack connected after flying.
- Handle your model with extreme care once the battery pack is connected and keep away from the propeller at all times. Never stand in-line or directly in front of any rotating parts.
- Do not immerse the ESC underwater while powered up.
- Do fly at a designated flying site and abide by the rules and guidelines set by your flying club.

Important Notice

Caution: A 5S LiPo battery greatly exceeds the maximum capacity of the ESC and motor and will result in ESC failure during flight. The 5S battery will cause a complete loss of control creating a potentially dangerous condition. Please do not use a 5S (18.5V) or larger battery in this product.



**[Http:// www.fmsmodel.com](http://www.fmsmodel.com)
Email: info@fmsmodel.com**